

Development a New Model of EEVC/WG17 Lower Legform for Pedestrian Safety

Alireza Noorpoor, Akbar Abvabi, and Mehdi Saeed Kiasat

Abstract—Development, calibration and validation of a three-dimensional model of the Legform impactor for pedestrian crash with bumper are presented. Lower limb injury is becoming an increasingly important concern in vehicle safety for both occupants and pedestrians. In order to prevent lower extremity injuries to a pedestrian when struck by a car, it is important to elucidate the loadings from car front structures on the lower extremities and the injury mechanism caused by these loadings. An impact test procedure with a legform addressing lower limb injuries in car pedestrian accidents has been proposed by EEVC/WG17. In this study a modified legform impactor is introduced and validated against EEVC/WG17 criteria. The finite element model of this legform is developed using LS-DYNA software. Total mass of legform impactor is 13.4 kg. Technical specifications including the mass and location of the center of gravity and moment of inertia about a horizontal axis through the respective centre of gravity in femur and tibia are determined. The obtained results of legform impactor static and dynamic tests are as specified in the EEVC/WG17.

Keywords—Legform impactor, Pedestrian safety, Finite element model, Knee joint, EEVC/WG17.

I. INTRODUCTION

VEHICLE structures have been developed these years to protect the occupations in collision. This has led to development of high strength vehicle bodies which deform to absorb energy during an impact, protecting the occupations from high forces. Euro NCAP has done different testes to examine the strength of vehicle bodies and the safety of a vehicle improve for occupations [1]. As a result of these efforts, the number and severity of automobile occupation injuries is on the decline. On the other hand, design of vehicle front structures is important for decreasing the pedestrian injuries. However, the protection of the pedestrians has received less attention.

The Bumper of a vehicle plays a major role to protect the

Manuscript received May 30, 2008.

Alireza Noorpoor is Assistant Professor in the Automotive Engineering Department, Iran University of Science and Technology, Iran (e-mail: Noorpoor@iust.ac.ir).

Akbar Abvabi is M.S Student in the Automotive Engineering Department, Iran University of Science and Technology, Iran (e-mail: a_abvabi@auto.iust.ac.ir).

Mehdi Saeed Kiasat is Assistant Professor in the Faculty of Marine Technology, Amirkabir University of Technology, Iran (e-mail: Kiasat@aut.ac.ir).

vehicle body damage in low speed impacts. Many bumpers, particularly in large vehicles are too stiff for pedestrian protection. In design of a new bumper for an automobile, pedestrian protection is as important as bumpers energy absorption in low speed collision and the efforts focused for designing an optimum bumper.

In the European Union more than 7000 pedestrians and 2000 pedal cyclists are killed every year in road accidents, while several hundred thousands are injured [2]. Serious or fatal injuries can be sustained at relatively low speeds between 25 and 50 km/h. Lower extremities and pelvis sustain injury are the most frequent cases [3]. Research into pedestrian protection has been carried out since 1960s [4]. In recent years there have been proposals in Europe to legislate requirements in this area and therefore considerable effort has been focused on developing a vehicle performance requirement. The European Enhanced Vehicle-Safety Committee (EEVC) has proposed a test procedure to assess the protection vehicles provide to pedestrians during a collision. In EEVC/WG17, pedestrian protection test consists of three impact tests:

- The headform impactor to bonnet top test.
- The legform impactor to bumper test.
- The upper legform impactor to bonnet leading edge test.

As leg injuries from the bumper are the most common injuries in nonfatal pedestrian accidents (38%), current investigations focus on the accident conditions in vehicle bumper-pedestrian leg injuries [5].

This procedure utilizes a legform impactor developed by the Transport Research Laboratory (TRL). The goal of this study is to establish a methodology to understand injury mechanisms of both ligament damages and bone fractures in car-pedestrian accidents.

Japanese car manufacturers and research groups JAMA and JARI have begun development of a more complex legform able to simulate the human long bone flexibility and possessing a mechanical knee joint that is a closer replication of a human knee. As this is the only alternative legform impactor, this impactor is compared with the EEVC/WG17 legform impactor in reference [6].

There is an ongoing process of definition and implementation of vehicle test standards that should lead manufacturers towards more pedestrian friendly vehicle front end designs. This process needs a deep understanding of:

- Accident statistical data.

- Pedestrian impact mechanism.
- Design possibilities available to vehicle manufacturers today and in the near future [7].

ISO have produced a specification for a legform impactor, but no impactor to meet it. A computer simulation models for pedestrian subsystem impact tests was conducted through the cooperation of TNO and JARI in Japan [8]. There are some environmental conditions that affect obtained results in EEVC legform impactor test. For instance with the increase in the relative humidity in legform impactor dynamic certification test, the maximum acceleration will be increased [9].

A pedestrian legform impactor is a tool for the evaluation of car front bumper aggressiveness when simulating a pedestrian leg hit by a car. Impact is imposed to the bumper at 40km/h velocity parallel to the longitudinal axis of the vehicle on at least three points where injuries or shape changes may result. The lower leg acceleration, knee shearing displacement and knee bending angle are measured. The lower leg acceleration is used to evaluate tibia fracture risk, and the shear displacement and bending angle are used to evaluate cruciate and collateral ligaments injury risks, respectively.

The maximum dynamic knee bending angle shall not exceed 15°, the maximum dynamic knee shearing displacement shall not exceed 6mm, and the acceleration measured at the upper end of the tibia shall not exceed 150g [2].

The main goal of the present study is to introduce a new legform dynamic model. A finite element method is also employed to understand injury mechanisms of both ligament damages and bone fractures.

II. STRUCTURE OF LEGFORM IMPACTOR

Pedestrian protection becomes of increasing concern in the world, especially in the EU. The European Enhanced Vehicle safety Committee (EEVC/WG10 and WG17) proposed component subsystem tests for cars to assess pedestrian protection as shown in Fig. 1.

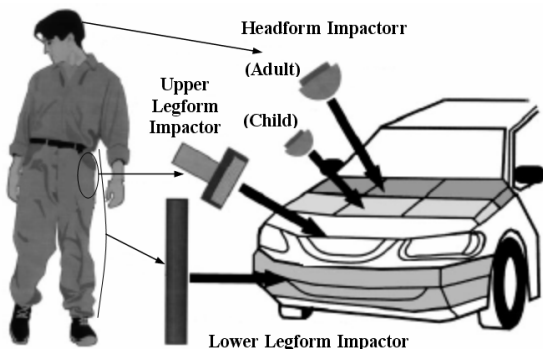

Fig. 1 EEVC pedestrian subsystem impact test

For determine the aggressivity of a bumper by using legform impactor, Impact is imposed at 40km/h horizontally in line with the automobile. The lower leg acceleration, knee shearing displacement and knee bending angle are measured

(as shown in Fig. 2).

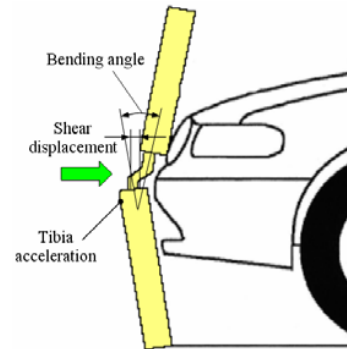

Fig. 2 Measurement parameters

The legform impactor that is used in this test is represented in EEVC/WG17.

Fig. 3 shows the structure of legform impactor. The legform impactor consists of two metal tubes with an outer diameter of 70mm representing tibia and femur. Physical properties like mass, moments of inertia and center of gravity for both femur and tibia, are specified in the EEVC/WG17 report.

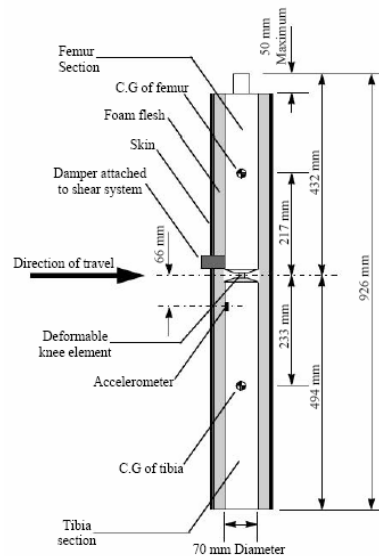

Fig. 3 Legform impactor with skin and foam covering [2]

A layer of confoar foam (CF-45; thickness 25mm) is used to model the flesh. The impactor is covered by a 6 mm thick neoprene skin.

The properties of confoar foam are important for achieving the exact results and in this study the material properties and stress-strain curve for foam were used by using data from references as shown in Table I and Fig. 4 respectively [10],[11].

TABLE I
FOAM MATERIAL PROPERTIES

Property	Test Reference or Apparatus	CF-45
Color	NA	Blue
Tear Resistance (lbf)	ASTM D3574(95)	4.6
Tensile Strength (psi)	ASTM D3574(95)	22.3
Elongation (%)	ASTM D3574(95)	108
Compression Set (%) (21°C)	ASTM D3574(95) 22 hrs @ 21°C Compressed 50%	<1.0
Compression Set (%) (70°C)	ASTM D3574(95) 22 hrs @ 70°C Compressed 50%	<1.0
Density (lb/ft ³)	ASTM D3574(95)	5.6-6.0

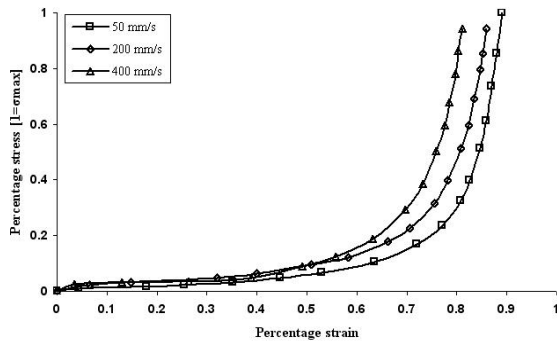

Fig. 4 Foam test results [10]

The exact mechanical properties for neoprene skin were used and the stress strain curve for neoprene is shown in Fig. 5 [12].

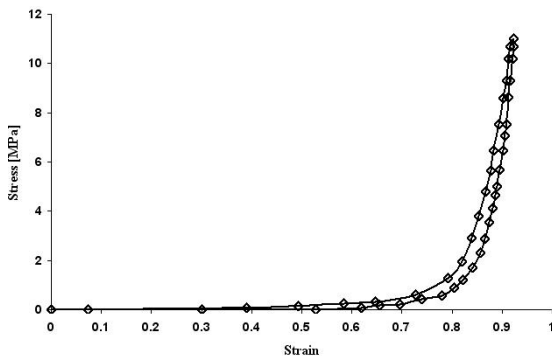

Fig. 5 Neoprene stress strain curve [11]

For validating of legform impactor, the EEVC/WG17 static and dynamic test procedures were used as follow:

A. Static Tests

By using one bending test and one shearing test, the knee joint was validated.

For bending test, the legform impactor, without foam covering and skin, was mounted with the tibia firmly clamped to a fixed horizontal surface and a metal tube connected firmly to the femur. A horizontal normal force was applied to the

metal tube at a distance of 2.0 ± 0.01 m from the centre of the knee joint as shown in Fig. 6.

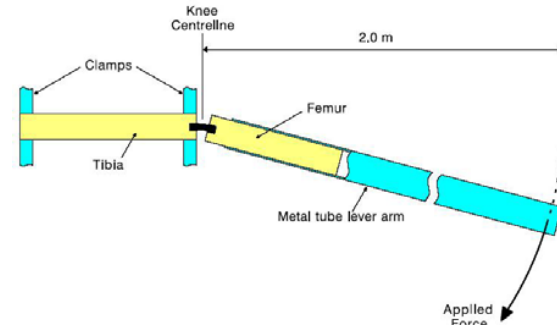

Fig. 6 Top view of test setup for static legform impactor bending certification [2]

For shearing test, the legform impactor without foam covering and skin, was mounted with the tibia firmly clamped to a fixed horizontal surface and a metal tube connected firmly to the femur and restrained at 2.0 m from the centre of the knee joint. A horizontal normal force shall be applied to the femur at a distance of 50 mm from the centre of the knee joint as shown in Fig. 7.

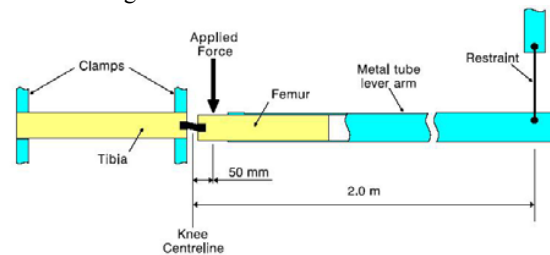

Fig. 7 Top view of test setup for static legform impactor shearing certification [2]

B. Dynamic Test

The legform impactor, including foam covering and skin, was suspended horizontally by three wire ropes of 1.5 ± 0.2 mm diameter and of 2.0 m minimum length.

The certification impactor shall be propelled horizontally at a velocity of 7.5 ± 0.1 m/s into the stationary legform impactor as specified in the EEVC/WG17 and shown in Fig. 8. The certification impactor moves only in the specified direction of impact.

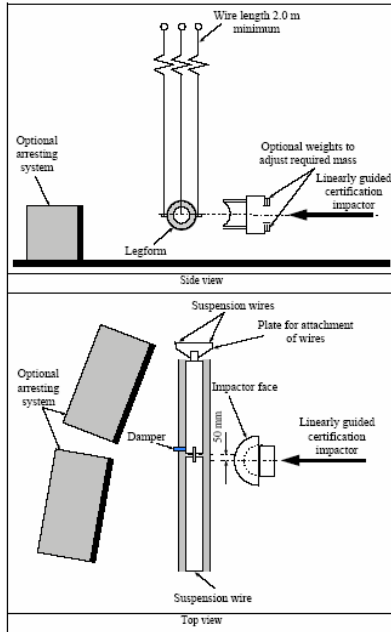

Fig. 8 Top view of test set-up for dynamic legform impactor certification [2]

III. MODELING OF LEGFORM IMPACTOR

For modeling of legform impactor, the bones of femur and tibia were modeled by using shell elements and After modeling the geometry of legform impactor for achieving the require mass, by using two lump masses in special locations as follow, the masses in the center of gravity of femur and tibia were tuned.

As specified in EEVC/WG17, The total mass of the femur and tibia shall be 8.6 ± 0.1 kg and 4.8 ± 0.1 kg respectively. By considering the mass density $\rho=96.11$ kg/m³ and $\rho=1100$ kg/m³ for cf-45 foam and neoprene skin respectively, the exact masses of bone of femur and tibia were achieved.

A 6 kg lump mass is used in femur and the distance of this mass from the lower point of tibia is calculated below.

$$m = \rho \times V \quad (1)$$

$$m_{flesh} = 0.281107 \text{ kg}$$

$$m_{skin} = 1.0241 \text{ kg}$$

$$m_{bone} = 7.2948 \text{ kg}$$

$$z = \frac{m_1 z_1 + m_2 z_2 + m_3 z_3 + m_4 z_4}{m_1 + m_2 + m_3 + m_4} \quad (2)$$

$$711 = \frac{(0.281107 \times 690) + (1.0241 \times 690) + (1.2948 \times 705.883)}{0.281107 + 1.0241 + 1.2948 + 6} + (6z_1)$$

$$0.281107 + 1.0241 + 1.2948 + 6$$

$$z_1 = 716.68 \text{ mm}$$

And for tibia by using 2 kg lump mass:

$$m_{flesh} = 0.354252 \text{ kg}$$

$$m_{skin} = 1.2906 \text{ kg}$$

$$m_{bone} = 3.15515 \text{ kg}$$

$$261 = \frac{(0.354252 \times 247) + (1.2906 \times 247) + (1.15515 \times 241.383)}{0.354252 + 1.2906 + 1.15515 + 2} + (2z_2)$$

$$0.354252 + 1.2906 + 1.15515 + 2$$

$$z_2 = 283.84 \text{ mm}$$

For better consideration, z_1 and z_2 are shown in Fig. 9.

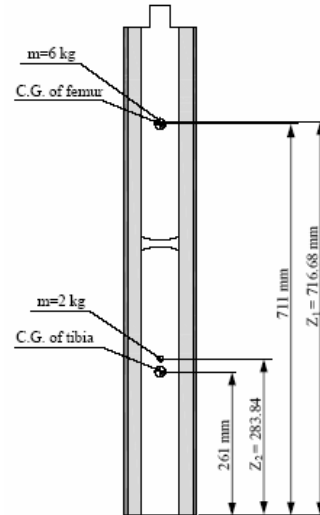

Fig. 9 Locations of added lump masses for femur and tibia

After calculating the moment of inertia of this model, by using lump moment of inertia, in center of gravity of femur and tibia, the moment of inertia that specified in the EEVC/WG17 report was achieved.

The calculations for femur are:

$$\text{Bone: } I_y = 0.021 \text{ kg.m}^2$$

$$\text{Skin: } I_y = 0.01515 \text{ kg.m}^2$$

$$\text{Flesh: } I_y = 0.003939 \text{ kg.m}^2$$

$$I_{C.G.} = I_o + mr^2 \quad (3)$$

$$I_{C.G.} = (I_o + mr^2)_{flesh} + (I_o + mr^2)_{skin} + (I_o + mr^2)_{bone} + (mr^2)_{added \text{ mass}} \quad (4)$$

$$I_{C.G.} = (0.003939 + (0.281107 \times 0.021^2)) + (0.01515 + (1.0241 \times 0.021^2)) + (0.021 + (1.2948 \times 0.0052^2)) + (6 \times 0.005682^2) = 0.04089 \text{ kg.m}^2$$

The moment of inertia of the femur about a horizontal axis through the respective centre of gravity and perpendicular to the direction of impact shall be 0.127 ± 0.010 kg.m², therefore the added moment of inertia in center of gravity of femur is:

$$I = 0.127 - 0.04089 = 0.08611 \text{ kg.m}^2$$

And for tibia:

$$I_{C.G.} = 0.0644 \text{ kg.m}^2$$

The moment of inertia of the tibia about a horizontal axis through the respective centre of gravity and perpendicular to the direction of impact shall be 0.120 ± 0.010 kg.m², therefore the added moment of inertia in center of gravity of tibia is:

$$I = 0.12 - 0.0644 = 0.0556 \text{ kg.m}^2$$

The geometrical properties of different parts of legform impactor are shown in Table II.

	Femur	Tibia
Added lump mass (kg)	6	2
Distance of added lump mass from lower point of tibia (mm)	716.68	283.84
Added lump moment of inertia in respective C.G. (kg.m ²)	0.04089	0.0644
Total mass (kg)	8.6	4.8
Total moment of inertia about the horizontal axis (kg.m ²)	0.127	0.12

The particular problem here is the characteristics of the knee joint between the femur and tibia and the characteristics of the foam and skin. Knee joint was modeled by using a 6-DOF discrete beam that the shearing of the knee represented by a linear force versus displacement curve and the bending response of the knee represented by a nonlinear moment versus rotational displacement curve. Other degrees of freedom of the knee joint were tuned so that the static and dynamic characteristics were achieved.

Solid elements with low density foam material (LS-DYNA material type 57) were selected for modeling cf-45 foam. By using material data sheet and the material properties that are explained in theory part, the exact model of flesh was achieved.

The skin was modeled by using solid elements with viscoelastic material and material data sheet. The mechanical properties of skin are explained in theory part.

Vibrations have been observed in dynamic certification test and by using a translational damper ($c=500$ Ns/m) in knee joint, the vibration in legform impactor was prevented.

For achieving exacter results, the elements near to impact location were modeled smaller.

After modeling of flesh and skin, the FEM model of legform impactor was achieved as shown in Fig. 10.

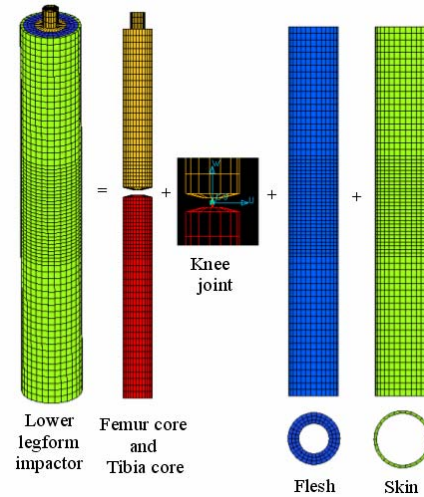

Fig. 10 Finite element model of legform impactor

IV. VALIDATION

The legform impactor model was validated according to the EEVC certification test as presented in theory part, and the results are as follow:

For the static test, bending and shearing tests were done. The resulting angle of knee deflection in static bending certification test was recorded, as shown in Fig. 11.

Energy versus angle is shown in Fig. 12 and the energy taken to generate 15.0° of bending was 98.79 J that is within 100 ± 7 J as specified in EEVC/WG17.

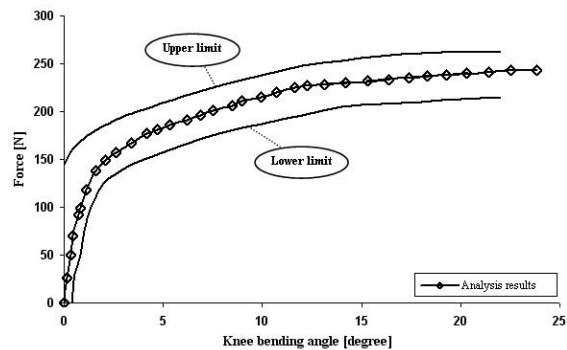

Fig. 11 Force versus angle in static bending certification test

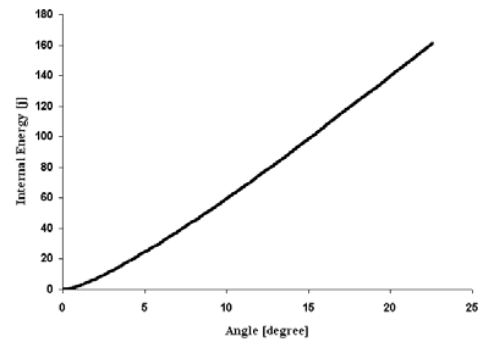

Fig. 12 Energy versus angle in static bending certification test

The resulting knee shearing displacement in static shearing certification test was recorded, as shown in Fig. 13.

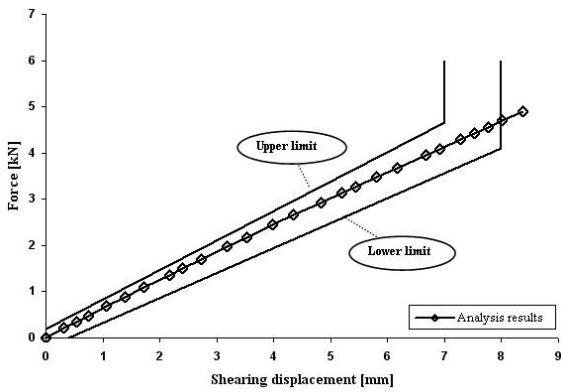

Fig. 13 Force versus displacement in static shearing certification test

For dynamic certification test, the legform impactor was suspended as explained in theory part and shown in Fig. 14.

Here, cables were modeled by using beam elements and cable discrete beam material.

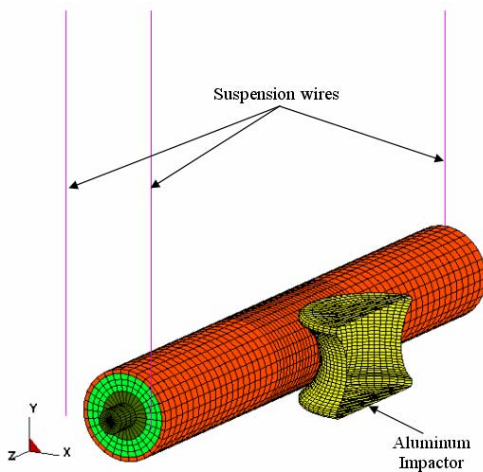
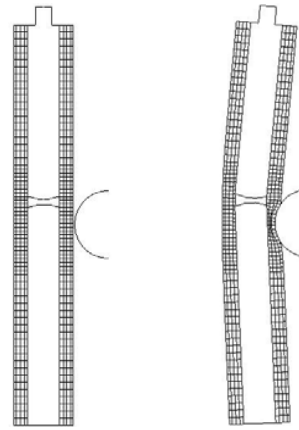

Fig. 14 Dynamic certification test

The deformation of legform impactor in dynamic certification test, knee bending angle, knee shearing displacement and tibia acceleration versus time are shown in Figs. 15, 16, 17, 18 respectively.



Before deformation After deformation

Fig. 15 Deformation of legform impactor in dynamic certification test

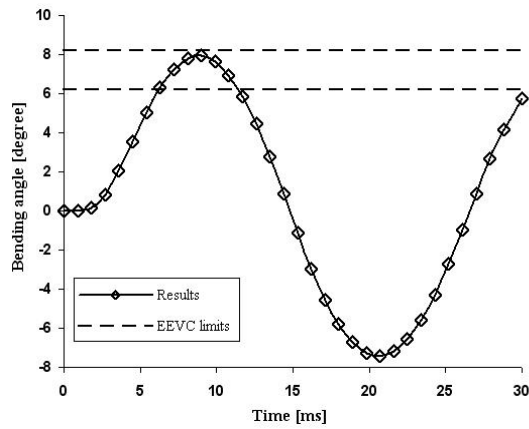

Fig. 16 Knee bending angle in dynamic certification test

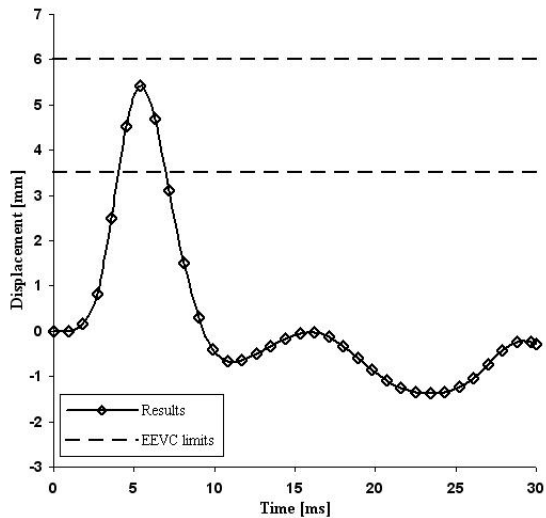

Fig. 17 Knee shearing displacement in dynamic certification test

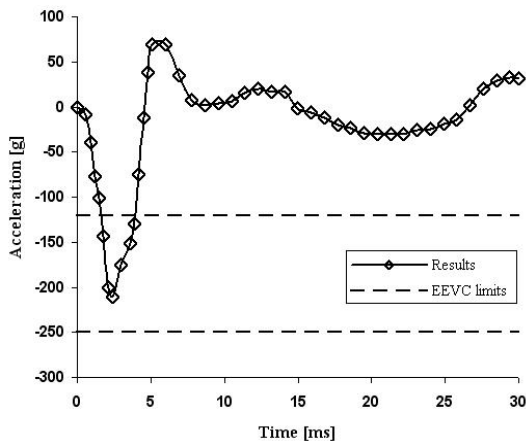

Fig. 18 Upper tibia acceleration in dynamic certification test

As aluminum impactor impacted to suspended legform in this analysis, the bending angle in legform is increased and about 10 ms after the time of collision, the maximum bending angle is occurred and then legform pushes the aluminum impactor in reverse side. After this instance, the unloading happen and as specified in EEVC/WG17, the maximum bending angle is important. Maximum knee shearing displacement is occurred about 5 ms after the impact instance and after that the knee shearing displacement is decreased. By using a shearing damper in knee joint, there is no vibration in this analysis. When the aluminum impactor is impacted to legform, the upper tibia acceleration is increased at first and the maximum upper tibia acceleration is occurred about 3 ms after the moment of impact. Then the amount of acceleration is decreased.

The results of dynamic test are shown in Table III that all of them are within the EEVC/WG17 limit.

TABLE III
ACHIEVED RESULTS FROM DYNAMIC CERTIFICATION TEST

	Upper tibia acceleration (g)	Maximum bending angle (degree)	Maximum shearing displacement (mm)
Analysis Result	211.23	7.93	5.41
EEVC Limit	120-250	6.2-8.2	3.5-6

V. RESULTS AND DISCUSSION

In legform impactor test, the achieving results that will be obtained with maximum deformation are important and after that when unloading happen, the deformation shape and results don't consider in pedestrian safety consideration and in this finite element model of legform impactor, the unloading in knee joint modeled as loading. For modeling an exact legform impactor model that shows the human's leg, the

unloading parameters in knee joint should be modeled different with loading.

In static bending certification test, force versus angle and the energy taken to generate 15.0° of bending angle are important. And the achieving results are as shown in Figs. 11,12 respectively. During this analysis, the force versus angle results is within the upper and lower limits and the energy taken to generate 15.0° of bending was 98.79 J that is within 100 ± 7 J as specified in EEVC/WG17. For static shearing certification test, force versus displacement in knee joint is important and the achieving results are as shown in Fig. 13 and in whole time of this test, the results are within the upper and lower limits. In dynamic certification test, three parameters are important as follow:

- Upper tibia acceleration
- Knee maximum bending angle
- Knee maximum shearing displacement

The time that maximum amount of three parameters are occurred are close to the time that were happened in a similar legform model [13] and against EEVC/WG17 the maximum archived results in this test are important.

In this study, knee maximum bending angle was 7.93° that is within 6.2° - 8.2° , maximum shearing displacement in knee joint was 5.41 mm that is within 3.5-6 mm and maximum upper tibia acceleration was 211.23g that is within 120-250g as specified in EEVC/WG17 and are shown in Figs. 16, 17, 18 respectively.

Totally it can said that here, all mechanical and physical properties and obtained results in static and dynamic tests are as specified in the EEVC/WG17 and this legform impactor can be used for pedestrian safety tests.

VI. CONCLUSION

As in nonfatal passenger vehicle pedestrian accidents, the lower extremities are the most commonly injured body parts, car manufactures usually use a legform impactor test for designing better and more friendly structures in pedestrian safety. In legform impactor models, there are many components for achieving exact model. The advantage of the finite element model of this study is that simple and optimized components are used. The accuracy of obtained results is better than those obtained using other models in some cases.

There are some environmental conditions that affect obtained results. Because the crush performance of the confore foam used to model the legform impactor is affected by both temperature and humidity. Therefore, the effect of humidity and temperature on the dynamic certification test setup should be investigated separately.

REFERENCES

- [1] European New Car Assessment Program (EuroNCAP), "Pedestrian Testing Protocol", Version 4.1, March 2004.
- [2] European Enhanced Vehicle-safety Committee, "Improved Test Methods to Evaluate Pedestrian Protection Afforded by Passenger Cars", EEVC Working Group 17 Report, 1998.
- [3] Svoboda, J., Solc, Z., Cizek, V., "Analysis of collision between pedestrian and small car", IJCrash Vol. 8 No. 3, 2003.

- [4] Yong, H., Young, w., "Optimization of Bumper Structure for Pedestrian Lower Leg Impact", Society of Automotive Engineering, 2002-01-0023.
- [5] Matsui, Y., "Effects of Vehicle Bumper Height and Impact Velocity on Type of Lower Extremity Injury in Vehicle Pedestrian Accidents", Accident Analysis and Prevention, March 2005.
- [6] Lawrence, g., Hardy. B., Carroll, J., Donaldson, w., Visvikis, c., Peel, d., "A Study on the Feasibility of Measure Relating to the Protection of Pedestrians and other Vulnerable Road Users", TRL, June 2004.
- [7] Svoboda, J., Cizek V., "Pedestrian – vehicle collision: vehicle design analysis", Society of Automotive Engineering, 2003-01-0896.
- [8] Konosu, A., Ishikawa, H., Kant, R., "Development of Computer Simulation Models for Pedestrian Subsystem Impact Tests", JSAE Review 21, 2000.
- [9] Matsui, Y., Takabayashi, M., "Factor Causing Scatter in Dynamic Certification Test Results for Compliance with EEVC WG17 Legform Impactor Standard", IJCrash Vol. 9 No. 1, 2004.
- [10] Jianfeng, Y., Jikuang, Y., Dietmar, O., "Investigation of Head Injuries by Reconstructions of Real-World Vehicle-Versus-Adult-Pedestrian Accidents", Safety Science, Article in Press, 2007.
- [11] Cappetti, N., Donnarumma, A., Naddeo, A., Russo, L., "Design of Experiment about Foam CF45 for Pedestrian Safety in Car Design", Journal of Materials Processing Technology 175, 2006.
- [12] Konosu, A., "Information on the Flexible Pedestrian Legform Impactor GT Alpha (Flex-GT α)", Flex-TEG Japan, April 2006.
- [13] Dutton, T., Solihull, A., "Finite Element Models for European Testing: Pedestrian Impactors to WG17", 4th European LS-DYNA Users Conference, May2003.