

Detection of Sags, Swells, and Transients Using Windowing Technique Based On Continuous S-Transform (CST)

K. Daud, A. F. Abidin, N. Hamzah, H. S. Nagindar Singh

Abstract—This paper produces a new approach for power quality analysis using a windowing technique based on Continuous S-transform (CST). This half-cycle window technique approach can detect almost correctly for initial detection of disturbances i.e. voltage sags, swells, and transients. Samples in half cycle window has been analyzed based continuous S-transform for entire disturbance waveform. The modified parameter has been produced by MATLAB programming m-file based on continuous s-transform. CST has better time frequency and localization property than traditional and also has ability to detect the disturbance under noisy condition correctly. The excellent time-frequency resolution characteristic of the CST makes it the most an attractive candidate for analysis of power system disturbances signals.

Keywords—Power quality disturbances, initial detection, half cycle windowing, continuous S-transform.

I. INTRODUCTION

POWER Quality Disturbances (PQD) issue has become an increased concern for electric utilities and their customers in last decades. By increasing use of solid state switching devices, non linear and power electronically switched loads, unbalanced power systems, lighting controls, computer and data processing equipment, as well as industrial plant rectifiers and inverters is resulting to poor power quality. Disturbances in quality of electric power supply is normally caused by power line disturbances such as voltage sags/swells with or without harmonics, momentary interruption, harmonic distortion, flicker, notch, spike and transients. All this disturbances causing the problems such as malfunctions, short lifetime, instabilities, failure of electrical equipments and so on.

The important issues in power quality analysis are to detect correctly and classify disturbance signals automatically in an efficient manner. Using signal processing technique, various types of PQ disturbances can be detected among others, in time, frequency and time-frequency domains. Several different techniques have been used so far in the literatures to detect power quality disturbance events. The most common technique used for detecting purpose is the calculation of the root mean square (RMS) value of the voltage supply. The main advantage

of this technique in terms of calculation, it is simple, fast and much sensitive in sags and swells but not able to detect during transients [8], [9]. But, the drawbacks of this technique it is dependence on the size of the sample window. A small window makes the RMS parameter less relevant, as it follows the tendency of the temporal signal, and loses the meaning of mean value of power [9].

Common frequency domain tools that are widely used are the fast Fourier transform (FFT) and the short time Fourier transform (STFT) [1]. This consists of the decomposition of the signal into a sum of sinusoid signals of different frequencies. This analysis can be viewed as a mathematical transformation from the time domain to the frequency domain. FFT is very useful in the analysis of harmonics and is an essential tool for filter design. However, there are some disadvantages such as losses of temporal information, so that it can only be used in the steady state, and cannot show the moment when the event is produced [12]. STFT has been used in power quality analysis due to its applicability to non-stationary signals. The most advantage of this technique is its ability to give the harmonic content of the signal at every time-period specified by a defined window. But, STFT also has the limitation of fixed window width chosen apriority and this causes limitations for low-frequency and high-frequency non-stationary signals analysis at the same time, the location on the time series may be lost or incorrect [10].

However, using wavelets transform (WT), both time and frequency information of the disturbance can be obtained [13]. The WT on the other hand uses a basis function which dilates and contracts with frequency. It uses short windows at high frequency and long windows at low frequency. Although WT has the capability to extract feature from the signal in both time and frequency domain simultaneously and has been applied in the detection and classification of power quality, it exhibits some disadvantages like excessive computation, sensitivity to noise level and the dependency of its accuracy on the chosen basis wavelet [2].

S-transform (ST) was also introduced recently in [4]-[6] as an effective technique for PQ disturbances signal processing. It is method for the feature extraction and also detection of PQ disturbances. ST is an extension to the ideas of continuous wavelet transform and is based on a moving and scalable localizing window and has characteristics superior to other transforms. This transform has the ability to detect the disturbance correctly in the presence of noise [2]. The other advantage of S-transform is that it avoids the requirement of

K. Daud and H. S. Nagindar Singh are with the Faculty of Electrical Engineering, Universiti Teknologi MARA, 13500 Pulau Pinang, Malaysia (e-mail: kamarul@ppinang.uitm.edu.my, harapajan@gmail.com)

A. F. Abidin and N. Hamzah are with the Faculty of Electrical Engineering, Universiti Teknologi MARA, 40450 Shah Alam, Malaysia (e-mail:ahmad924@salam.uitm.edu.my, noralizah@salam.uitm.edu.my)

testing various families of wavelets so as identify the best one for accurate classification [6]. Further, the decomposition of the disturbance signals at different resolution levels is not required in the S-transform, thereby reducing the memory size and computational overhead [3].

This paper proposed a technique based on S-transform for efficient detection of power quality disturbance especially voltage sag, swell and transient. This technique called half-cycle windowing that applied to the power quality disturbances signal based on Continuous S-transform (CST). Each samples of half-cycle window for entire disturbance signal are analyzed based on ST-contour matrices. All the sample windows obtained from the half-cycle windowing technique are analyzed continuously based on Continuous S-transform. The Continuous S-transform is used to extract the features that can characterize the voltage sag, swell and transient into s-matrices form. So, the significant features from the disturbance signals are continuous extracted by half-cycle windows technique based on continuous S-transform. The most significance contribution of this paper is the new approach technique that applied to detect the voltage sag, swell and transient by an initial detection properly. This approach applied based on Continuous S-transform to get an automatic detection of power quality disturbances type.

II. CONTINUOUS S-TRANSFORM

A. S-Transform

The S-transform [7] of a time series $h(t)$ is defined as

$$S(\tau, f) = \int_{-\infty}^{\infty} h(t) g(\tau - t, f)^{-i2\pi ft} dt \quad (1)$$

where f is the frequency, τ and t are both time.

The Gaussian modulation function $g(\tau, f)$ is given by

$$g(\tau, f) = \frac{|f|}{\sqrt{2\pi}} e^{-\tau^2 / 2\sigma^2} \quad (2)$$

and $\sigma = \frac{1}{|f|}$. The final expression as follow

$$S(\tau, f) = \int_{-\infty}^{\infty} h(t) \left\{ \frac{|f|}{\sqrt{2\pi}} e^{-((\tau-t)^2 f^2 / 2)} e^{-i2\pi ft} \right\} dt \quad (3)$$

The CWT $W(\tau, d)$ of a $h(t)$ function is defined as

$$W(\tau, d) = \int_{-\infty}^{\infty} h(t) w(t - \tau, d) dt \quad (4)$$

The S-transform is obtained by multiplying the CWT with a phase factor as

$$S(\tau, f) = e^{i2\pi ft} W(\tau, d) \quad (5)$$

The final form of the continuous S-transform is obtained as

$$S(\tau, f) = \int_{-\infty}^{\infty} h(t) \left\{ \frac{1}{\sigma(f)\sqrt{2\pi}} e^{-((\tau-t)^2 f^2 / 2\sigma(f)^2)} e^{-i2\pi ft} \right\} dt \quad (6)$$

The width of the Gaussian window is

$$\sigma(f) = T = \frac{1}{|f|}$$

The inverse S-transform is like

$$h(t) = \int_{-\infty}^{\infty} \left[\int_{-\infty}^{\infty} S(\tau, f) d\tau \right] e^{i2\pi ft} df \quad (7)$$

If additive noise is added to the signal $h(t)$, the operation of the S-transform as

$$S\{h_{noisy}(t)\} = S\{h(t)\} + S\{\eta(t)\} \quad (8)$$

The discrete Fourier transform of the time series $h(t)$ is obtained as

$$H\left[\frac{n}{NT}\right] = \frac{1}{N} \sum_{k=0}^{N-1} h(kt) e^{-i2\pi mk} \quad (9)$$

where $n=0, 1, \dots, N-1$, ($N \geq 1$)

The generalized S-transform of a discrete time series $h(t)$ is derived by letting $\tau \rightarrow jT$ and $f \rightarrow n/NT$ is like

$$S(jT, \frac{n}{NT}) = \sum_{m=0}^{N-1} H\left[\frac{m+n}{NT}\right] G(m, n) e^{i2\pi mj/N} \quad (10)$$

where $G(m, n) = e^{-2\pi^2 m^2 \alpha^2 / n^2}$, j, m and $n=0, 1, \dots, N-1$

Based on the DFT, the discrete inverse of the S-transform is obtained as

$$h[kt] = \frac{1}{N} \sum_{n=0}^{N-1} \left\{ \sum_{j=0}^{N-1} S\left[\frac{n}{NT}, jT\right] \right\} e^{i2\pi mk} \quad (11)$$

where j and $n=0, 1, \dots, N-1$

III. DETECTION CAPABILITY OF THE WINDOWING TECHNIQUE BASED CONTINUOUS S-TRANSFORM

The S-transform is having edge over the wavelet transform in detecting a disturbance under a noisy condition. It has the ability to detect the occurrence of disturbance correctly in the presence of noise. The S-transform performs multiresolution analysis on a time varying signal as its window width varies inversely with frequency. This gives high time resolution at high frequency and high frequency resolution at low frequency

[11]. Since power quality disturbances make the power signal a non-stationary one, the S-transform can be applied effectively.

In this paper, the disturbance signals are generated from IEEE13 bus using PSCAD simulation. Three types of power quality disturbances, i.e. voltage sags, swells and transients are generated and the features of all types of disturbances are extracted from the S-contour matrix by using MATLAB programming. From the S-contour matrix, important information in terms of magnitude, frequency, standard deviation and phase can be extracted. To demonstrate the detection capability of this technique based on half-cycle window based on continuous S-transform, three types of disturbances, i.e. voltage sag, swell and transient along with some of the important features are presented in Figs. 2-15. For simplicity, only three disturbances (sag, swell, and transient) are shown here. In Figs. 2, 7, 12, represent the voltage sag,

swell, and transient signal respectively generated from PSCAD simulation. Figs. 3 and 8 represent the frequency contour of the S-matrix for the voltage sag and swell signal. Also, in Figs. 4, 9, 13 represent the output waveform of new approach in this paper; the initial detection of power quality disturbances for voltage sag, swell and transient. This technique presents the ability of initial detection for the voltage sag, swell and transient correctly compared with RMS technique that lack in transient detection. Similarly, Figs. 5, 10, and 14 represent the half cycle windowing technique with modified parameters (miw) for voltage sag, swell and transient (for sample, N=64). Figs. 6, 11, and 15 represent the st contour for parameter (miw) for voltage sag, swell, and transient. This parameter (miw) will be use for the next part of research; feature selection by using ANOVA and classification.

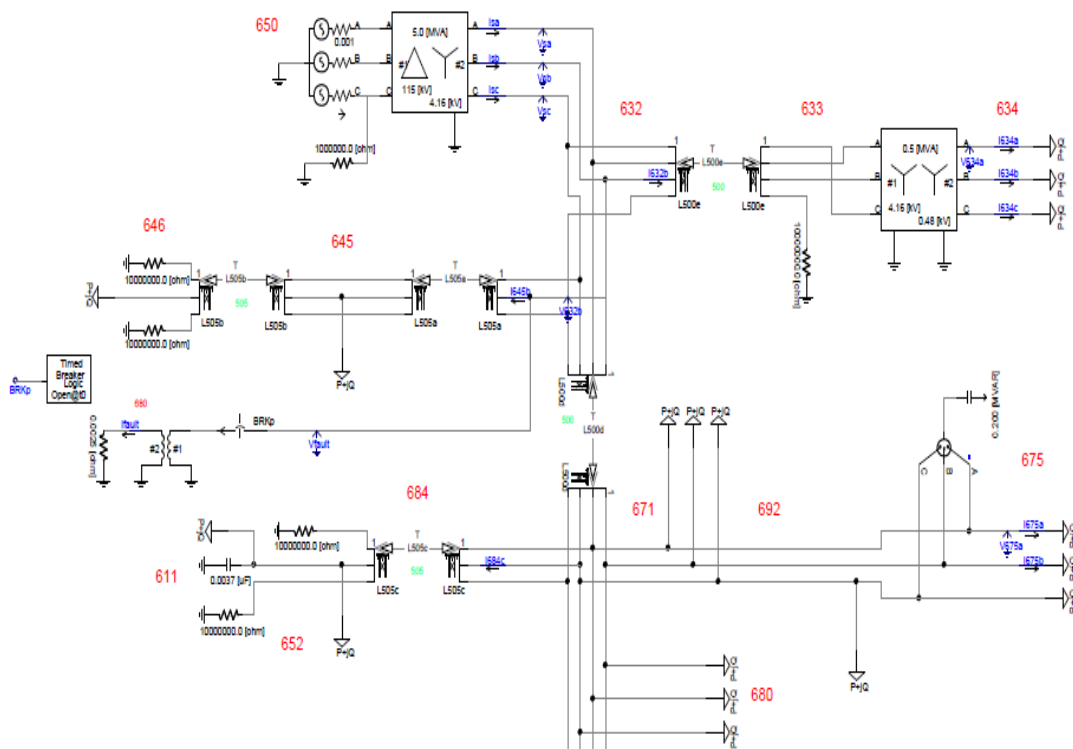

Fig. 1 IEEE 13 bus PSCAD simulation

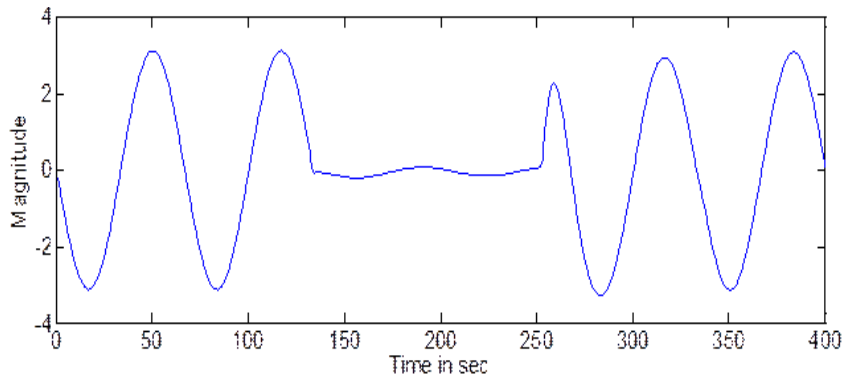

Fig. 2 Voltage sag signal

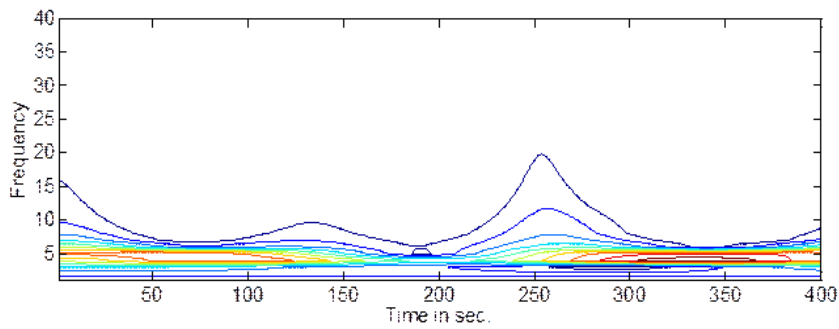

Fig. 3 S-matrix contour of voltage sag

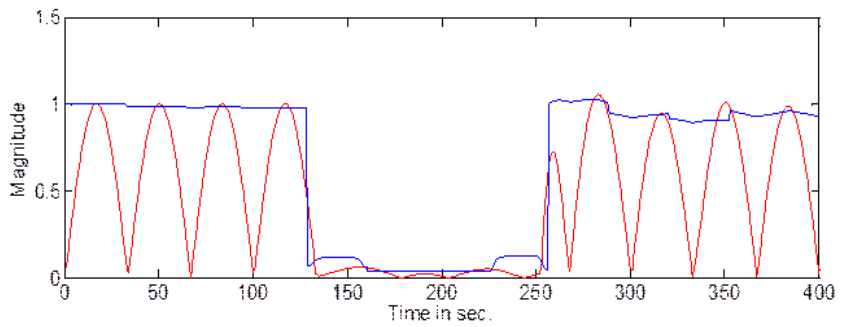

Fig. 4 Initial detection of voltage sag

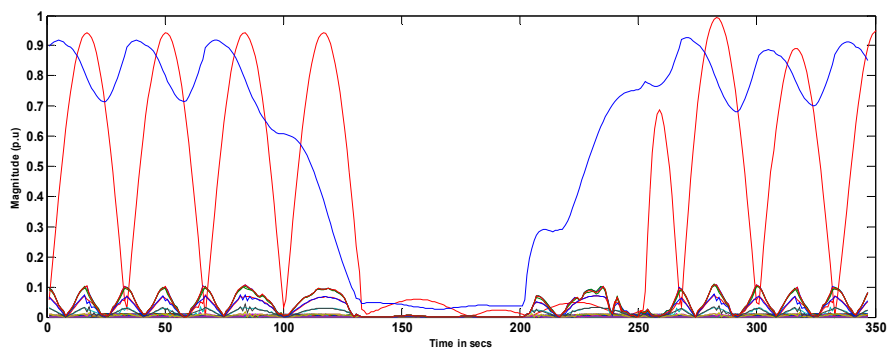

Fig. 5 Half cycle Windowing Technique (samples, N=64) with modified parameters (miw) for sag signal

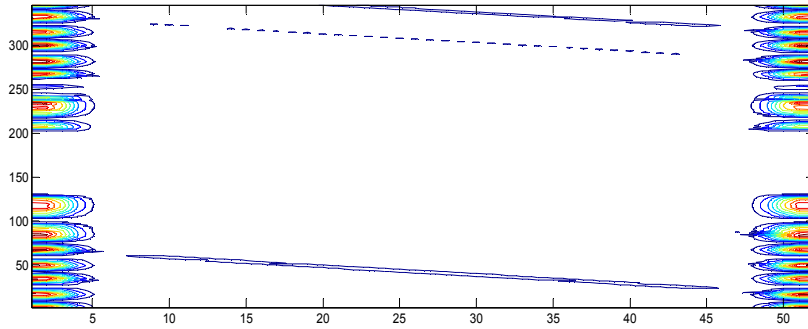

Fig. 6 St contour for parameter (miw) for voltage sag

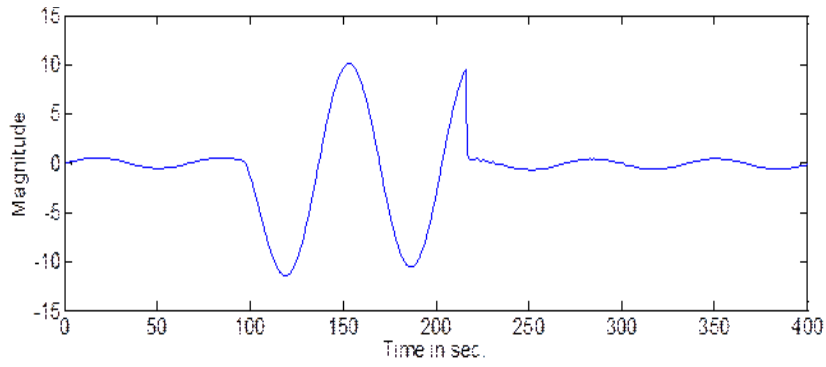

Fig. 7 Voltage swell signal

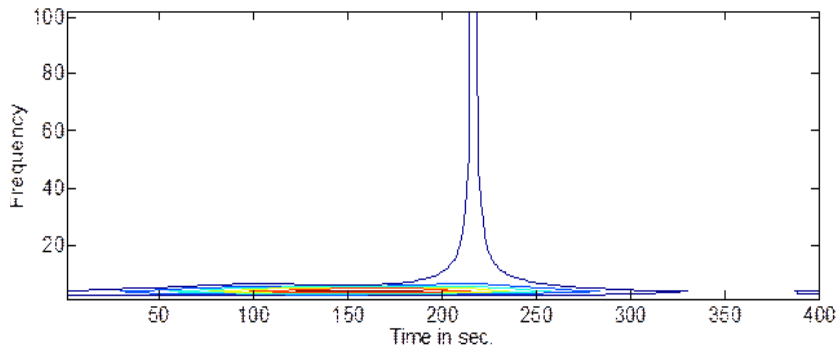

Fig. 8 S-matrix contour of swell signal

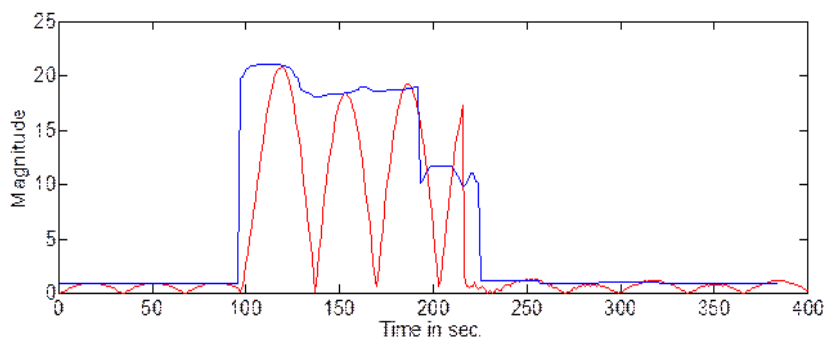

Fig. 9 Initial detection of voltage swell

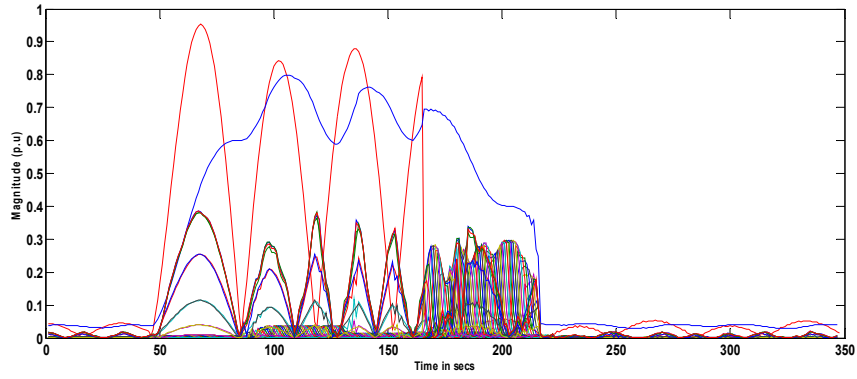

Fig. 10 Half cycle Windowing Technique (samples, N=64) with modified parameters (miw) for swell signal

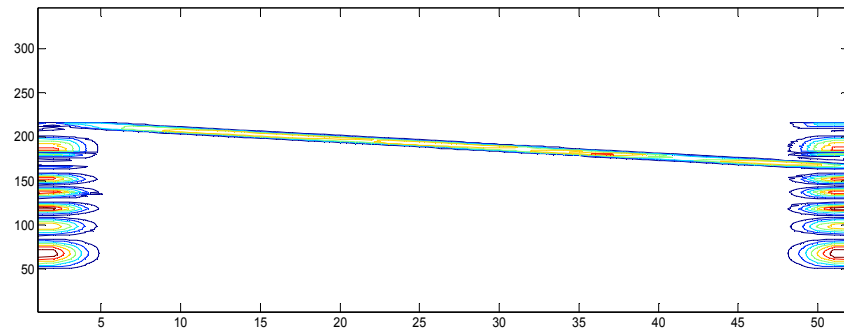

Fig. 11 St contour for parameter (miw) for swell signal

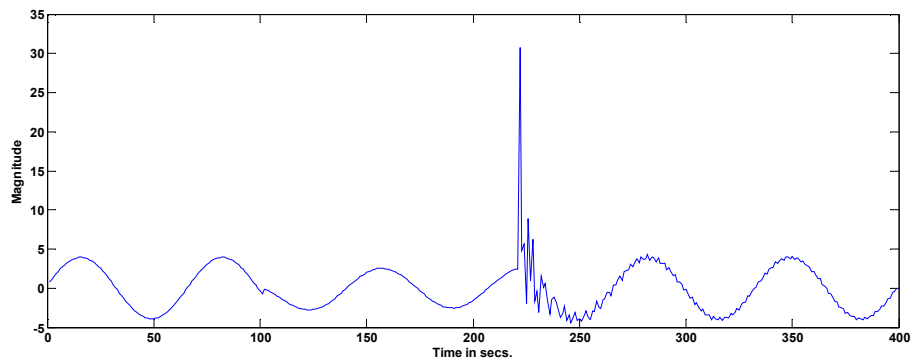

Fig. 12 Transient signal

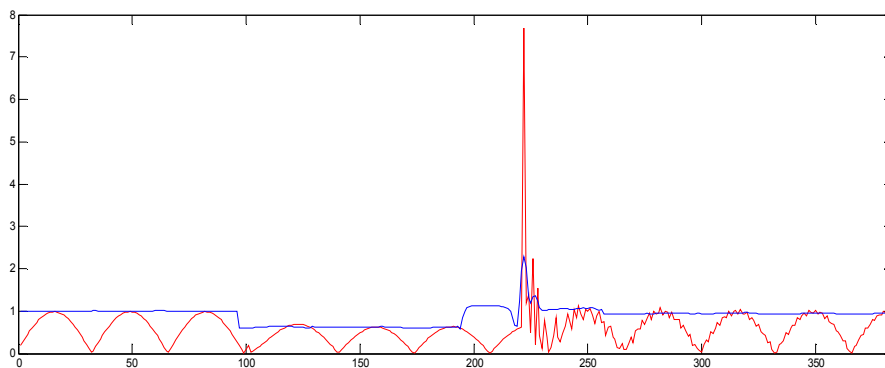

Fig. 13 Initial detection for transient

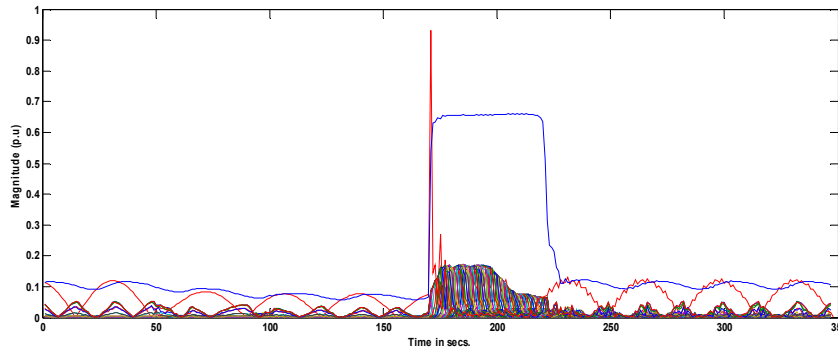

Fig. 14 Half cycle Windowing Technique (samples, N=64) with modified parameters (miw) for transient signal

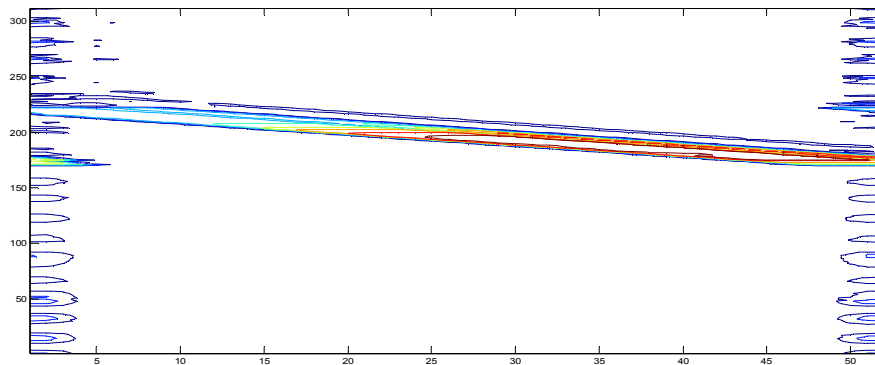

Fig. 15 St contour for parameter (miw) for transient signal

IV. CONCLUSION

In this paper, an attempt has been made to extract efficient feature and detect the PQ disturbances (sag, swell and transient) using half-cycle windowing technique based continuous S-transform (CST). This paper proposed an improvement technique for initial detection of voltage sag, swell and transient. It is observed that by half-cycle window technique can obtain a correctly detection for PQ disturbances as published in [14]. And the technique could be proved as feasible and effective by more simulation results for another types PQ disturbances. Therefore, the proposed technique can be used as PQ event detection.

REFERENCES

- [1] A. Moussa, M. el-Gammal, E. Abdallah, and A. El-SLoud, "Hardware-software structure for on-line power quality assessment", in proceedings of the 2004 ASME/IEEE Joint, pp 147-152, (2004).
- [2] S. Mishra, C. N. Bhende, and B. K. Panigrahi, "Detection and classification of power quality disturbance using s-transform and probabilistics neural network", IEEE Trans. Power Delivery, vol.23, no.1, pp. 280-287, (2008).
- [3] L. Mansinha, R. G. Stockwell, R. P. Lowe, M. Eramian, and R. A. Schincariol, "Local s-spectrum analysis of 1-D and 2-D data," Physics of the Earth and Planetary Interiors, vol.103, pp.329-336, (1997).
- [4] M. V. Chilukuri and P. K. Dash, "Multiresolution S-transform-based fuzzy recognition system for power quality events", IEEE Trans. Power Del., vol.19(1), pp. 323-330, (2004).
- [5] S. Kaerwarsa, "Classification of power quality disturbances using s-transform based artificial neural networks", IEEE International Conf. of Intelligent Computing and Intelligent systems, pp.566-570, (2009).
- [6] P.K. Dash, B.K. Panigrahi, and G.Panda, "Power quality analysis using S-transform", IEEE Trans. On Power Delivery, vol. 18(2), pp. 406-411, (2003).
- [7] R.G. Stockwell, L.Mansinha, and R.P. Lowe, "Localization of the complex spectrum: The S-transform," IEEE Trans. Signal Processing vol.44, no.4, pp.998-1001, (1996).
- [8] V. Matz, T. Radil, P. Ramos and A.Cruz Serra, "Automated power quality monitoring system for on-line detection and classification of disturbances", IEEE Conf. Proceedings of Instrumentation and Measurement Technology (IMTC2007), pp.1-6, (2007).
- [9] U. N. Khan, "Signal processing used in power quality monitoring", Conf. Proceedings of the International Conference on Environment and Electrical Engineering, pp. 1-4, (2009).
- [10] M. Nayak, B.S. Panigrahi, "Advanced signal processing technique for feature extraction in data mining," International Journal of Computer applications, vol.19, no.9, pp.30-37, (2011).
- [11] M.F. Faisal, and A. Mohamed, "Identification of sources of voltage sags in the Malaysian distribution networks using SVM based s-transform," IEEE Region 10 Conference, (2009).
- [12] T.Y. Vega, V. F. Roig, and H. B. San Segundo, "Evolution of signal processing techniques in power quality", International Conf. on Electrical Power Quality and Utilisation, pp. 1-5, (2007).
- [13] N. Huang, L. Lin, W. Huang, and J. Qi, "Review of power quality disturbance recognition using s-transform", International Conf. on Control, Automation and Systems Engineering, pp.438-441, (2009).
- [14] K. Daud, A. F. Abidin, N. Hamzah, and H. S. N. Singh, "New windowing technique detection of sags and swells based on continuous s-transform (CST)", International Journal of New Computer Architectures and their Applications (IJNCAA), 2(4), pp. 550-555, (2012).

Kamarulazhar Bin Daud received her MSc (Electronic Systems Design Engineering) from Universiti Sains Malaysia in 2006 and Bachelor in

Electrical Engineering (Hons.) from Universiti Teknologi MARA in 2003. He is a lecturer at Universiti Teknologi MARA Pulau Pinang and currently pursuing her PhD in Universiti Teknologi MARA, Shah Alam. His research interests are power quality, power electronic and artificial intelligence.

Dr. Ahmad Farid Bin Abidin received the B.E.E.S degree from Universiti Kebangsaan Malaysia (UKM), Malaysia, in 2000, M.S.E.E. from Universiti Teknologi MARA (UiTM), Malaysia, in 2005 and PhD from Universiti Kebangsaan Malaysia (UKM), Malaysia, in 2011. He is currently a lecturer at the Faculty of Electrical Engineering, UiTM Shah Alam, Malaysia. His research interests are in power system protection and power quality.

Assoc. Prof. Dr. Noraliza Binti Hamzah received her B Eng. (Hons) from University of Wales Institute of Science and Technology, in 1988, MSc. (Power System) from University of Malaya (UM), Malaysia in 1993 and PhD from Universiti Kebangsaan Malaysia (UKM). She is currently a senior lecturer at the Faculty of Electrical Engineering, UiTM Shah Alam, Malaysia. Her research interest is power quality, artificial intelligence and power electronic studies.

Ir. Harapajan Singh Nagindar Singh is a Senior Lecturer in Universiti Teknologi MARA Pulau Pinang and holds a Master of Engineering with Distinction (Electrical) from University of Nottingham, UK, and a Diploma in Engineering (Electrical) from Universiti Teknologi Malaysia. Ir. Harapajan is a professional, competent electrical engineer with over 30 years of lecturing experience in the electrical engineering field. He specializes in electrical safety, operation and maintenance of electrical systems and has wide range of knowledge and experience in government and industry.