

Design and Implementation of an Intelligent System for Detection of Hazardous Gases using PbPc Sensor Array

Mahmoud Z. Iskandarani, and Nidal F. Shilbayeh

Abstract—The voltage/current characteristics and the effect of NO₂ gas on the electrical conductivity of a PbPc gas sensor array is investigated. The gas sensor is manufactured using vacuum deposition of gold electrodes on sapphire substrate with the lead-phthalocyanine vacuum sublimed on the top of the gold electrodes. Two versions of the PbPc gas sensor array are investigated. The tested types differ in the gap sizes between the deposited gold electrodes. The sensors are tested at different temperatures to account for conductivity changes as the molecular adsorption/desorption rate is affected by heat. The obtained results found to be encouraging as the sensors showed stability and sensitivity towards low concentration of applied NO₂ gas.

Keywords—Intelligent System, PbPc, Gas Sensor, Hardware, Software, Neural.

I. INTRODUCTION

THE gases absorbed on the surfaces of the organic materials have a marked effect on the electrical conductivity of these materials; where the electrical conductivity of an organic material that contains transition and heavy central atoms changes by many orders of magnitude when a gas adsorbs on its surface.

Adsorption involves the formation of bonds between the adsorbed gas and the organic material, by transfer of electrical charge. The charge transfer changes the electronic structure of the material; changing its conductivity. Changes in the conductivity are related to the number of gas molecules adsorbed on the surface, and hence, to the concentration of the adsorbed species in the surrounding atmosphere. The measurement of changes in electrical conductance due to gas adsorption makes organic materials ideal for the detection of low gas concentration.

The conductivity of an organic material can either be affected at the surface with no bulk interaction, or following the reaction at the surface; carriers can be injected into the bulk causing both surface and bulk conductivities to be affected [8, 11, 17].

Mahmoud Z. Iskandarani is with Faculty of Science and Information Technology, Al-Zaytoonah Private University of Jordan, P.O.BOX 911597, Post Code: 11191, Amman-Jordan (e-mail: m_iskandarani@yahoo.com).

Nidal F. Shilbayeh is with Faculty of Information Technology, Jordan University for Graduate Studies, P.O.BOX 41, Post Code: 11931, Amman-Jordan, (e-mail: n_shilbayeh@yahoo.com).

When a gas molecule chemisorbs on the surface of the organic material, an electron or electrons may be transferred from one to the other, where the direction of transfer depends on the electro negativity of the gas and the work function of the solid. Also the physisorption of the gas plays an important role in the overall mechanism of gas adsorption and subsequent conductivity changes in the organic material. The adsorption of the gas molecules as ions on the surface removes electrons from the solid and localizes them at the surface, thus generation electron traps in the solid. This result in an increase in the hole concentration and therefore an increase in the conductance as the material will function as a P-type material.

In this paper the properties of the PbPc sensor array is confirmed and employed in an intelligent discriminating and controlling system. The system uses the inter-digital geometry together with PbPc film properties to distinguish between types of gases and alert to any increase in the level of these gases above acceptable levels.

II. BACKGROUND

A. Metal-Phthalocyanines

They are a group of organic materials known to have several properties that make them attractive as a potential gas sensing materials or gas detectors. They have the following desirable properties:

1. They are considered to be good electrical conductors, where the charge carriers are known to be positive holes [2, 3, 25].
2. Reaction of Phthalocyanines with electron accepting gases should increase its conductivity.
3. They are thermally stable to temperatures in excess of 400 degrees centigrade.
4. They can be used for extended periods at elevated temperatures.
5. Organic groups can be easily modified and functional groups can be substituted on either ring structure or on the central hydrogen atom in the metal-free Phthalocyanines (H₂Pc).

Several of the Metal-Phthalocyanine materials (e.g. commercial materials) contain significant amounts of impurities which can result in irreproducible electrical characteristics, which can be purified using either Gas-

Entrainer Sublimation (in Nitrogen or Oxygen) or by Vacuum Sublimation (the used technique in our work). The purification process leads to stable and reproducible electrical characteristics. Early studies of Phthalocyanines showed that many are sensitive to the presence of NO_2 with an increase in the sensitivity observed when the Phthalocyanines contains heavier central atoms.

Metal-Phthalocyanines organic semiconductors found to undergo conductivity changes upon the adsorption of strongly electrophilic gases such as NO_2 , Cl_2 and F_2 . The magnitude and reversibility of these conductivity variations found to be dependant on the central metal species. Because of their high decomposition temperatures (450 Degrees Centigrade), Phthalocyanines can be vacuum evaporated to produce thin films. The deposition of such films on the surface of a substrate eliminates some of the complications arising from having to consider both surface and bulk conductivities in the analysis process. The absence of bulk conductivity effect will improve the response and recovery times of the designed sensor array. However, the presence of impurities will affect resistivity, linearity, hysteresis and drift of the electrical characteristics. Also the conduction activation energy and the specific conduction mechanism will be affected.

Electron transfer between adsorbed molecules and the semiconductor surface causes changes in the conductivity. The electrical conduction takes place via individual SnO_2 grains. NO_2 gets chemisorbed at the surface of SnO_2 grains. Hereby they trap electrons at the surface. SnO_2 in a n-type semiconductor. Hence the trapping of the free electrons causes a decrease in free charge carrier concentration and therefore an increase in the sensor resistance

B. Lead-Phthalocyanines (PbPc)

It is the most sensitive and stable Phthalocyanine material. Although, insensitive to a wide range of gases (e.g. weak electrophilic and electrophobic gases and CH_4 , CO , CO_2 , H_2O , H_2 , Hydrocarbons and changes in O_2 pressure), PbPc based sensor is very sensitive and potentially useful in detecting strong electrophilic gases particularly to NO_2 or NO_x and will respond to low concentrations of F_2 and less than 1ppm concentration of Cl_2 gases. Thus it could form the basis of a highly sensitive and selective NO_2 or NO_x sensor and it is suitable for detecting these gases at concentrations from 1ppb to 10 ppm in air and retains discrimination to concentrations above 100ppm.

Since PbPC has high sensitivity and selectivity to strongly accepting gases such as NO_2 , Cl_2 , F_2 , and O_3 , discrimination between strongly accepting gases and other gases is achieved by careful choice of operating temperatures. However, the stability and electrical properties of this type of sensors is affected by water vapor, so a heating element is usually fitted to the back of the sensor to eliminate such-factor.

It is found [25] that PbPc sensor is most sensitive to NO_2 gas and can be operated in a continuous mode at temperatures above 100 degrees C with its sensitivity and stability decreasing as the temperature approaches 200 Degrees C.

These temperatures are also a function of PbPc film thickness deposited on the substrate and can be extended when thick films are used.

III. PBPC SENSOR DESIGN

The sensor is based on a sapphire substrate ($\text{Alpha-Al}_2\text{O}_3$), which usually contains traces of Fe and Ti ions. The substrate has a very high melting point (about 2050 Degrees C). It is very hard and quite inert, especially towards acids. The substrate has an area of 12.5 mm by 12.5mm. Different types of electrode gap separations are produced to study the effect of inter-electrode separation of sensor sensitivity as shown in the SEM photographs in fig.1-2.

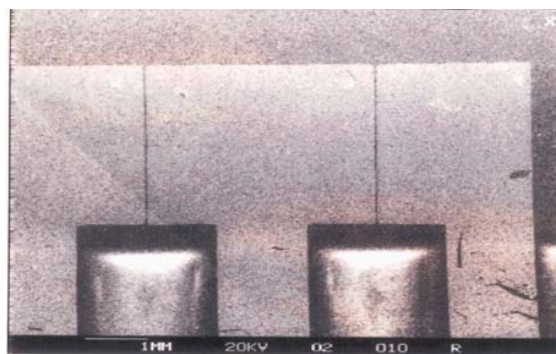

Fig.1 10:10:10 Gap Ratio

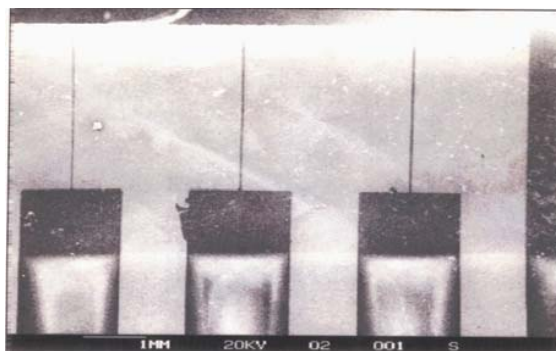

Fig.2 5:10:15 Gap Ratio

IV. EXPERIMENTAL SETUP

The sensor is mounted on a transistor like base as shown in fig.3, as it comprises three gaps. A testing chamber is built with air and temperature controls supplied through a computer controlled unit.

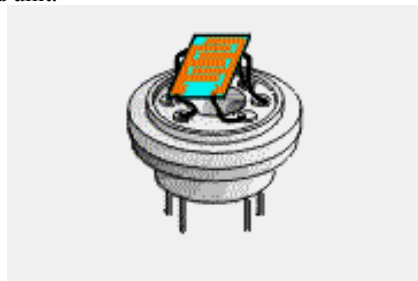

Fig.3 Sensor Mounting

Electrical characteristics of the sensor and its response to gases are recorded via specially designed hardware/software system as shown in fig. 4 [13, 18, 21, 24].

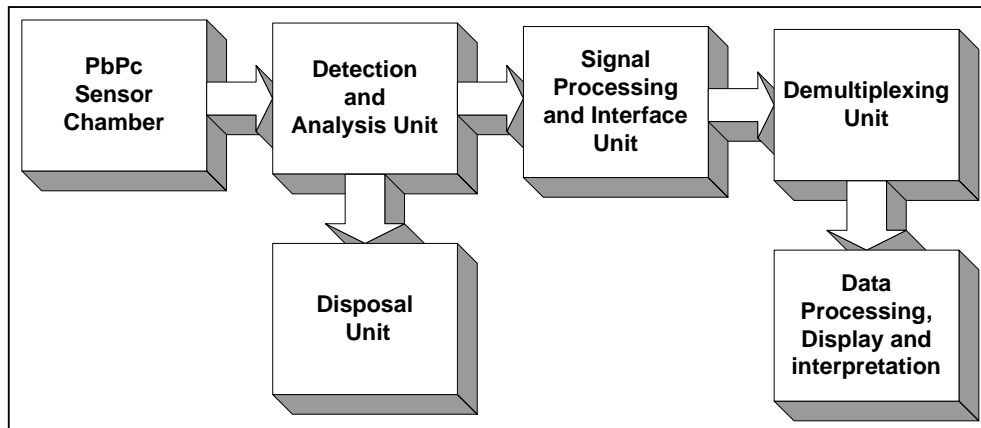

Fig.4 Testing System

The DC conductivity sensor consists of a resistive layer, which is deposited on top of electrode structure. The electrode structure is usually an inter-digital structure for keeping the resistance in an easy to measurable range. One the backside of the substrate holds a heater, for keeping the sensor at the appropriate operation temperature, and a thermo-resistor for rechecking the resulting temperature.

The substrates can be miniaturized and mounted on commercial standard sockets.

Gases in the atmosphere interact with the resistive layer. The gases get absorbed onto the sensor surface and depending on the nature of their interaction electrons are trapped or released into the bulk. Changes in the ambient atmosphere reflect in changes in the sensor resistance as shown in fig.5.

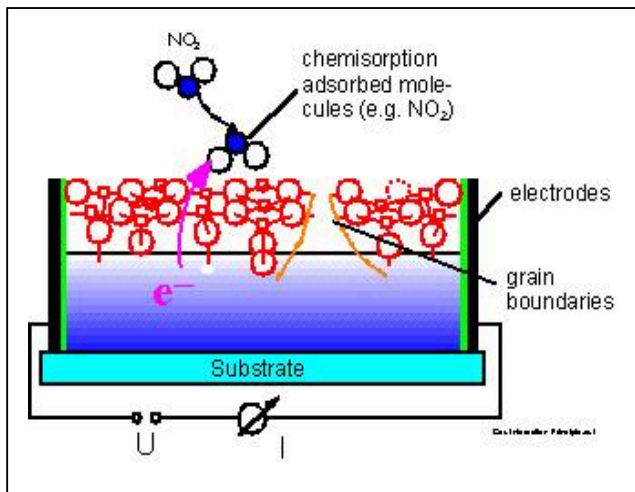

Fig.5 Sensor Interaction with NO₂ Gas

The measured conductivity is a combination of a conductivity contribution of the surface, which is affected by the gas, and a conductivity contribution of the bulk, which is typically unaffected at the operation temperature of the sensor.

A. Sensor Interface Circuit

The obtained signals from the PbPc sensor array is known to have relatively small values, hence, a differential amplifier interface circuit is designed and used to condition the sensor output signal to the remaining part of the signal processing system, which also includes A/D converter and noise filters. The basic amplifying unit is shown in fig.6 [5, 9, 12].

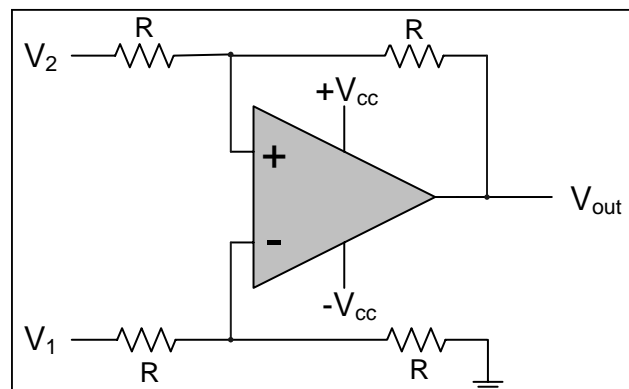

Fig.6 Differential Amplifier Interface Unit

In fig.6 each two inter electrodes produce a voltage signal proportional to the gap size and film thickness of the deposited PbPc film. The difference in the voltage of each two electrodes is amplified and processed to the next stage. The Amplifying unit acts as an impedance matcher, so that a correct measure of the detected gas level is acquired with minimal signal loss.

B. Interfacing Algorithm

After digitizing the amplified and cleaned sensor array signals, they are processed then analyzed using the algorithm shown in fig7.

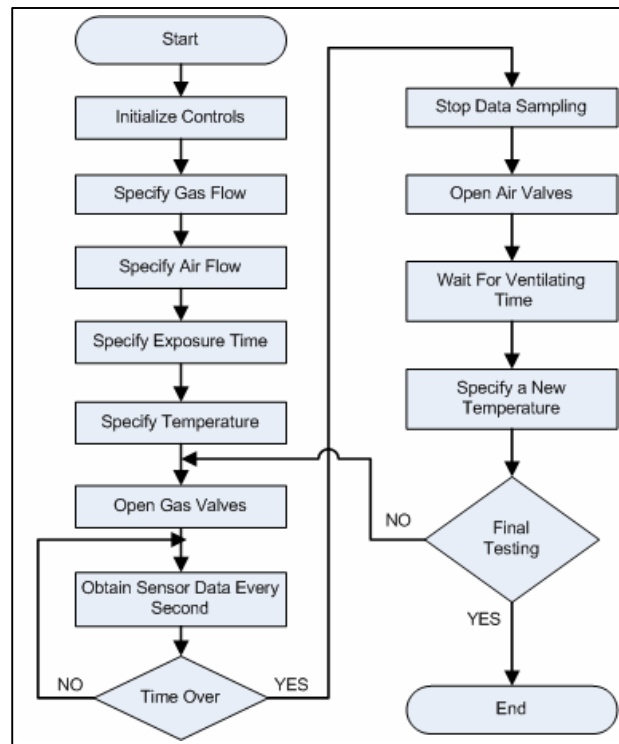

Fig.7 Interface Algorithm

I. DISCUSSION AND CONCLUSION

Tables (I, II, III) show the testing results of our array sensor, which clearly indicates an increase in the output signal response of the sensor as a function of three main factors:

1. Distance between conducting electrodes (Inter-digital separation).
2. Increase in atmospheric temperature.
3. Effect of gas concentration.

These factors can be used to control the behavior of the sensor in terms of the amount and type of adsorbed odors and the rate of desorption. The table also shows that the increase in output signal current is exponential. The mathematical law governing the response of the sensor is affected by the way the Organic Semi conducting layer is sublimed and its thickness and uniformity.

TABLE I
SENSOR CONDUCTANCE / CONCENTRATION AT 110 DEGREE C

| Gas Concentration ppm | Sensor Array Conductance ohms ⁻¹ | | |
|-----------------------|---|--------|--------|
| | Gap 5 | Gap10 | Gap15 |
| 0 | 332.2 | 469.9 | 582.9 |
| 1 | 1071.2 | 1354.1 | 1853.2 |
| 3 | 1733.1 | 2164.5 | 3355.7 |
| 5 | 2411.4 | 2670.9 | 4480.3 |
| 7 | 3282.9 | 3614.1 | 5379.2 |
| 9 | 3457.8 | 4096.7 | 5779.1 |

TABLE II
SENSOR CONDUCTANCE / CONCENTRATION AT 130 DEGREE C

| Gas Concentration ppm | Sensor Array Conductance ohms ⁻¹ | | |
|-----------------------|---|--------|--------|
| | Gap 5 | Gap10 | Gap15 |
| 0 | 308.1 | 337.7 | 361.7 |
| 1 | 1267.8 | 1445.1 | 1518.3 |
| 3 | 2340.3 | 2785.5 | 2939.4 |
| 5 | 3111.4 | 3601 | 3790.8 |
| 7 | 3522.4 | 4196.4 | 4490.4 |
| 9 | 3996.8 | 4486.3 | 4990 |

TABLE III
SENSOR CONDUCTANCE / CONCENTRATION AT 150 DEGREE C

| Gas Concentration ppm | Sensor Array Conductance ohms ⁻¹ | | |
|-----------------------|---|--------|--------|
| | Gap 5 | Gap10 | Gap15 |
| 0 | 81.1 | 167.2 | 236.2 |
| 1 | 327.3 | 679.7 | 882.3 |
| 3 | 753.2 | 1620.5 | 1834.2 |
| 5 | 1406.3 | 2503.1 | 2523.9 |
| 7 | 1445.1 | 3099.8 | 3448.3 |
| 9 | 2480.2 | 3671.1 | 3906.3 |

Overall the obtained characteristics of the tested groups of sensors very much agree with the literature and more proves the response shape of such sensor to be a specific case of power law response, which is a real exponential. Each sensor can be modeled as a group of three sensors grouped together which initiates the need to use pattern recognition and smart classification techniques for complex analysis.

Using initially obtained values of voltage, temperature, and inter electrode separation, a neural model is built as shown in fig.8 [4, 7, 10].

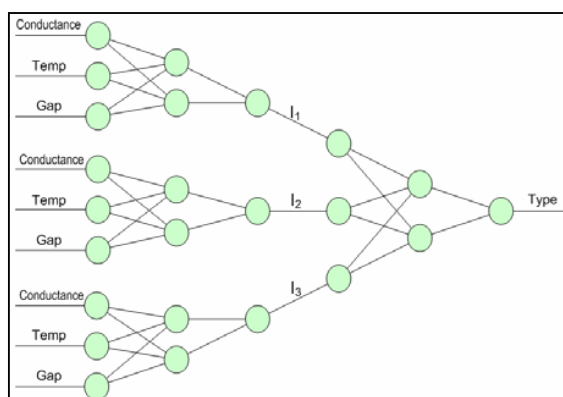

Fig.8 Neural Model for sensor array

This model associates the three mentioned important parameters, which implicitly determined the sensor array currents that enable the system to determine and predict level of gas concentration and type of detected gas. The model operates using back propagation principles such that the sensor array system can be used as both gas type discriminator and gas level controller. Both applications are very important in terms of distinguishing between types of gases (e.g. Normal or hazardous) and if the level of gas exceeds a preset safe limit will operate as a controlling system indicator.

The constructed neural model is tested to after being trained using Back propagation algorithm. Table IV shows the predicted results for the 5:10:15 sensor array at 110 Degrees C. The obtained neural results are evidently very close to the experimental ones. This is partly due to proper pruning of the neural network and the use of several hidden layers [14, 15, 16, 19, 20, 22, 23].

TABLE IV
PREDICTED VALUES FOR THE 5:10:15 SENSOR ARRAY

| Gas Concentration | G ₁ | G ₂ | G ₃ |
|-------------------|----------------|----------------|----------------|
| 0 | 319 | 451 | 560 |
| 1 | 1028 | 1300 | 1779 |
| 3 | 1664 | 2078 | 3221 |
| 5 | 2315 | 2564 | 4301 |
| 7 | 3152 | 3470 | 5164 |
| 9 | 3319 | 3933 | 5548 |

REFERENCES

- [1] P. Pasini, N. Powar, R. Gutierrez-Osuna, S. Daunert and A. Roda, "Use of a gas-sensor array for detecting volatile organic compounds in chemically induced cells", *Journal of Analytical and Bioanalytical Chemistry*, vol 378, pp. 76-83, 2004.
- [2] R. Gutierrez-Osuna and N. U. Powar, "Odor Mixtures and Chemosensory Adaptation in Gas Sensor Arrays", *International Journal on Artificial Intelligence Tools*, vol. 12, no. 1, pp. 1-16, 2003.
- [3] R. Gutierrez-Osuna and A. Gutierrez-Galvez, "Habituation in the KIII Olfactory Model with Chemical Sensor Arrays", *IEEE Transactions on Neural Networks* vol. 14, no. 6, pp. 1565-1568, 2003.
- [4] R. Gutierrez-Osuna, A. Gutierrez-Galvez and N. U. Powar, "Transient Response Analysis for Temperature Modulated Chemoresistors", *Sensors and Actuators B: Chemical B* vol. 93, no. 1-3, pp. 57-66, 2003.
- [5] A. Perera, T. Sundic, A. Pardo, R. Gutierrez-Osuna and S. Marco, "a Portable Electronic Nose Based on Embedded PC Technology and

- GNU/Linux: Hardware, Software and Applications”, *IEEE Sensors Journal*, vol. 2, no. 1-3, pp. 235-246, 2002.
- [6] Boilot, E.L. Hines and J.W. Gardner, “Knowledge extraction from electronic nose data sets using hybrid neuro-fuzzy systems”, in *Sensors Update*, 8, (H. Baltes, W. Gpel, J. Hesse, Series Eds.), Wiley-VCH Verlag GmbH, Weinheim, pp.73-94, ISBN 3-527-30258-1. (2001). (C)
- [7] M. Cole, J.W. Gardner, D.C. Dyer and P.N. Bartlett, “Low-drift Odour and Vapour Ratiometric Resistive Elements for Analogue CMOS Smart Sensors”, 8th *International Symposium on Olfaction and the Electronic Nose*, pp. 25-30 March, Washington DC, USA, (2001).
- [8] Carotta M.C., Martinelli G., Crema L., Malagù C., Merli M., Ghiotti G., Traversa E., “Nanostructured thick film gas sensors for atmospheric pollutant monitoring: quantitative analysis on field tests”, *Sensors and Actuators B*, vol. 76, pp. 336-342, 2001.
- [9] J.W. Gardner, H.W. Shin, E.L. Hines and C.S. Dow, “An Electronic Nose System for Monitoring the Quality of Potable Water”, *Sensors & Actuators B*, vol. 69, pp.336-341, 2000.
- [10] H.W. Shin, J.W. Gardner and E.L. Hines, “An Electronic Nose System to Diagnose Illness”, *Sensors & Actuators B*, vol. 70, pp. 19-24, 2000.
- [11] J.V. Hatfield, J.A. Covington and J.W. Gardner, “GasFETs incorporating conducting polymers as gate materials”, *Sensors & Actuators B*, vol 65, pp. 253-256, 2000.
- [12] R. Gutierrez-Osuna and H. T. Nagle, “A Method for Evaluating Data-Preprocessing Techniques for Odor Classification with an Array of Gas Sensors”, *IEEE Transactions on Systems, Man, and Cybernetics B*, vol.. 29, no. 5, pp. 626-632, 1999.
- [13] M. Cole, J.W. Gardner, A.W.Y. Lim, P.K. Scivier and J.E. Brignell, “Polymeric resistive bridge gas sensor array driven by a standard cell CMOS current drive chip”, *Sensors and Actuators B*, vol. 58, pp. 518-525, 1999.
- [14] J. W. Gardner, E.L. Hines, F. Molinier, P.N. Bartlett, T.T. Mottram, “Prediction of the health of dairy cattle from breath samples using a neural network with parametric model of the dynamic response of an array of semiconducting gas sensors”, *Proc. of IEE: Science, Measurement & Technology*, vol. 146, no. 2, pp. 102-106, 1999.
- [15] E. Llobet, E.L. Hines, J.W. Gardner and S. Franco, “Non-destructive banana ripeness determination using a neural network based electronic nose”, *Measurement Science and Technology*, vol. 10, no. .6, pp. 538-548, 1999.
- [16] E.L. Hines, E. Llobet and J.W. Gardner, “Neural network based electronic nose for apple ripeness determination”, *Electronic Letters*, vol. 35, no.10, pp.821-823, May, 1999.
- [17] J. W. Gardner, E. Llobet and E.L. Hines, “PSPICE model for resistive gas and odour sensors”, *Proc. IEE Circuits, Devices and Systems*, vol. 146, no. 3, pp.101-104, June, 1999.
- [18] E.L. Hines, E. Llobet and J.W. Gardner, “Electronic noses: a review of signal processing techniques”, *Proc. IEE Circuits, Devices and Systems*, vol. 146, no. 6, pp. 297-310, December, 1999.
- [19] E. Llobet, E.L. Hines, J.W. Gardner, P.N. Bartlett and T.T. Mottram, “Fuzzy ARTMAP based electronic nose data analysis”, *Sensors and Actuators B*, vol. 61, pp. 183-190, 1999.
- [20] J.W. Gardner, M. Craven, C. Dow and E.L. Hines, “The prediction of bacteria type and culture growth phase by an electronic nose with a multi-layer perceptron network”, *Measurement Science and Technology*, vol. 9, pp. 120-127, 1998.
- [21] D.C. Dyer and J.W. Gardner, High precision intelligent interface for a hybrid electronic nose, *Sensors and Actuators B*, vol. 62, pp. 724-728, 1997.
- [22] D. S. Vlachos, D. K. Fragoulis and J. N. Avaritsiotis, “An adaptive neural network topology for degradation compensation of thin film tin oxide gas sensors”, *Sensors and Actuators B: Chemical*, vol. 45, no. 3, pp. 223-228 December 1997.
- [23] D. Vlachos and J. “Avaritsiotis Fuzzy neural networks for gas sensing”, *Sensors and Actuators B: Chemical*, vol. 33, no. 1-3, pp. 77-82, July 1996.
- [24] J.W. Gardner, E.L. Hines and C. Pang, “Detection of vapours and odours from a multisensor array using pattern recognition: self-organising adaptive resonance techniques”, *Measurement & Control*, 29, pp.172-178, 1996.
- [25] J.W. Gardner, M. Z. Iskandarani, “Effect of Electrode Geometry on Gas Sensitivity of Lead Phthalocynine Thin Film”, *Sensors and Actuators B*, pp. 133-142, 1992.