

# Bidirectional Chaotic Synchronization of Non-Autonomous Circuit and its Application for Secure Communication

Mada Sanjaya, Halimatussadiyah, and Dian Syah Maulana

**Abstract**—The nonlinear chaotic non-autonomous fourth order system is algebraically simple but can generate complex chaotic attractors. In this paper, non-autonomous fourth order chaotic oscillator circuits were designed and simulated. Also chaotic non-autonomous Attractor is addressed suitable for chaotic masking communication circuits using Matlab® and MultiSIM® programs. We have demonstrated in simulations that chaos can be synchronized and applied to signal masking communications. We suggest that this phenomenon of chaos synchronism may serve as the basis for little known chaotic non-autonomous Attractor to achieve signal masking communication applications. Simulation results are used to visualize and illustrate the effectiveness of non-autonomous chaotic system in signal masking. All simulations results performed on non-autonomous chaotic system are verify the applicable of secure communication.

**Keywords**—Bidirectional chaotic synchronization, double bell attractor, secure communication

## I. INTRODUCTION

THERE are two types of chaotic systems, autonomous and non-autonomous. Although there are many known autonomous chaotic oscillators very few non-autonomous have been introduced in the literature. Non-autonomous chaotic circuits form a class of systems which produce chaos while being driven by an external time varying source. The amplitude and frequency of the sinusoidal signal both contribute to the chaotic dynamics of the system.

Chaos behavior can occur everywhere, even in very simple and low-dimensional nonlinear systems. The well known Poincare'-Bendixon theorem [1,2], requires an autonomous continuous time state space model to be at least three-dimensional in order to have bounded chaotic solutions. On the other hand, for non-autonomous systems, chaos can appear in two-dimensional models. There are many examples, such as Lorenz [3], and Rössler [4] systems that have been widely studied. Electronic circuits that consist of two nonlinear elements can be used to verify theoretical predictions. As an example, nonlinear Duffing forced oscillators have been experimentally studied [5]. Another popular example is the nonlinear chua's circuit, built and experimentally examined [6-

7]. Chaos and chaotic systems have many fields of applications. One of the popular practical application is secure communication. Synchronization of chaotic systems and chaos based secure communications have become an area of active research in recent years[8-12]. Different approaches are proposed and being pursued.

Chaotic signals depend very sensitively on initial conditions, have unpredictable features and noise like wideband spread spectrum. So, it can be used in various communication applications because of their features of masking and immunizing information against noise. The chaos communication fundament is the synchronization of two chaotic systems under suitable conditions if one of the systems is driven by the other. Since Pecora and Carrol [13],[14] have demonstrated that chaotic systems can be synchronized, the research in synchronization of couple chaotic circuits is carried out intensively and some interesting applications such as communications with chaos have come out of that research.

This paper focuses on design of non-autonomous chaotic oscillator and signal masking circuits. The brief is organized as follows. In Section II, mathematical models of the non-autonomous chaotic oscillator system are studied. In Section III, numerical simulation and MultiSIM circuit design and their simulations of the non-autonomous chaotic oscillator system are obtained. In Section IV, the bidirectional coupling method is applied to synchronize non-autonomous chaotic oscillator system. In Section V, chaotic masking communication circuits and their simulations of the non-autonomous chaotic oscillator system are realized also Matlab and MultiSIM. Section VI contains conclusions.

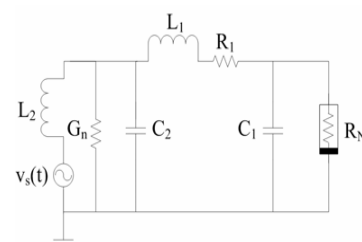

Fig. 1 4<sup>th</sup> order on-autonomous chaotic circuit models[15]

## II. MATHEMATICAL MODELS OF NON-AUTONOMOUS CHAOTIC CIRCUIT

The low frequency response of a 4<sup>th</sup> order non autonomous, nonlinear electronic circuit has been studied. The electronic circuit consists of two active elements, one linear negative conductance and one nonlinear resistor exhibiting a symmetrical piecewise linear v-i characteristic of N-type. The circuit contains also two capacitances  $C_1$  and  $C_2$ , two

Mada Sanjaya is with the Department of Physics, Faculty of Science and Technology, Universitas Islam Negeri Sunan Gunung Djati, Bandung, Indonesia (e-mail: madasws@gmail.com).

Halimatussadiyah, was with the Department of Physics, Faculty of Science and Technology, Universitas Islam Negeri Sunan Gunung Djati, Bandung, Indonesia (e-mail: female\_science@ymail.com).

Dian Syah Maulana is with the Department of Physics, Faculty of Science and Technology, Universitas Islam Negeri Sunan Gunung Djati, Bandung, Indonesia (e-mail: maulanasite@gmail.com).

inductances  $L_1$  and  $L_2$  and a sinusoidal input source  $v_s(t)$  [15]. Applying Kirchoff's law, the non-autonomous circuit is described by four differential equations:

$$\left. \begin{aligned} C_1 \frac{dv_{C1}}{dt} &= i_{L1} - i_N \\ C_2 \frac{dv_{C2}}{dt} &= -g_n v_{C2} + i_{L2} - i_{L1} \\ L_1 \frac{di_{L1}}{dt} &= v_{C2} - v_{C1} - i_{L1} r_1 \\ L_2 \frac{di_{L2}}{dt} &= -v_{C2} - i_{L2} r_2 + v_m \sin(2\pi f t) \end{aligned} \right\} \quad (1)$$

where  $v_s(t)$  is the input sinusoidal signal, while  $R_2$  denotes the internal resistance of the source.

Function  $g(v_{C1})$  is defined

$$i_N = g(v_{C1}) = m_0 v_{C1} + \frac{1}{2}(m_1 - m_0)[|v_{C1} + B_p| - |v_{C1} - B_p|] \quad (2)$$

where  $m_1$  and  $m_0$  are the slopes in the inner and outer regions, respectively, and  $\pm B_p$  denote the breakpoints.

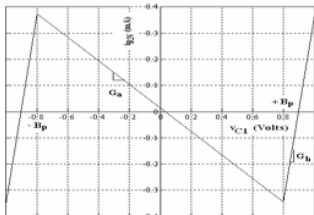
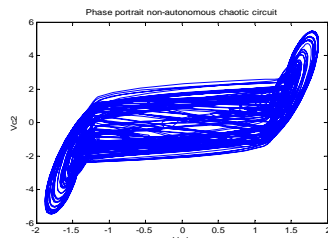

Fig. 2 Nonlinear resistor function [15]

III. NUMERICAL SIMULATION AND CIRCUIT IMPLEMENTATION

We present numerical simulation to illustrate the dynamical behavior of non-autonomous chaotic circuit from system (1). For numerical simulation of chaotic systems defined by a set of differential equations such as non-autonomous chaotic circuit, different integration techniques can be used in simulation tools. In the MATLAB numerical simulations, ODE45 solver yielding a fourth-order Runge-Kutta integration solution has been used.

According to these numerical simulations, the circuit's chaotic dynamics and double-bell attractors are shown in Fig.



(a) Phase portrait  $v_{C1}$  vs  $v_{C2}$

3. For showing the dynamics of the system (1), the parameter set given as fixed parameters, see Table 1. We have studied system's response in low frequencies range. Particularly, the numerical simulation and experimental simulation of phase portraits  $v_{C2}$  vs.  $v_{C1}$  for the frequency  $f = 50$  Hz and the amplitude  $v_m = 2$  volt of input sinusoidal signal  $v_s(t)$  are shown in this section.

TABLE I  
CIRCUIT PARAMETERS

Element	Description	Value	Tolerance
$L_1$	Inductor	100mH	$\pm 10\%$
$L_2$	Inductor	300mH	$\pm 10\%$
$C_1$	Capacitor	33nF	$\pm 5\%$
$C_2$	Capacitor	75nF	$\pm 5\%$
$R_1$	Resistor	1k $\Omega$	$\pm 5\%$
$R_2$	Resistor	1 $\Omega$	$\pm 5\%$
$R_3$	Resistor	2k $\Omega$	$\pm 5\%$
$R_4$	Resistor	2k $\Omega$	$\pm 5\%$
$R_5$	Resistor	2k $\Omega$	$\pm 5\%$
$R_6$	Resistor	1k $\Omega$	$\pm 5\%$
$R_7$	Resistor	15.5k $\Omega$	$\pm 5\%$
$R_8$	Resistor	4.1k $\Omega$	$\pm 5\%$
$R_9$	Resistor	297k $\Omega$	$\pm 5\%$
$U_1$	TL082CD		
$U_2$	TL082CD		
$g_n$	Negative Resistor	-0.475 ms	
$m_0$	Outer gradient	5 ms	
$m_1$	Outer gradient	-0.35 ms	
$B_p$	Breakpoint voltage	1.2 volt	

Now we shall prove that the strange attractor shown in Fig. 3. is actually chaotic in nature. For this we will first calculate all the Lyapunov exponents associated with the strange attractor shown in Fig. 3(a). The spectrum of Lyapunov exponent is shown in Fig. 3(b). One can see that the largest Lyapunov exponent thus calculated is positive, showing that the strange attractor is chaotic in nature.

The complete implementation of the non-autonomous chaotic circuit design using MultiSIM software is shown in Fig. 4. The function of nonlinear resistor as see in Fig. 2, are implemented with the analog operational amplifier. By comparing Fig. 3, and Fig. 5, it can be concluded that a good qualitative agreement between the numerical integration of (1) using Matlab, and the circuits simulation using MultiSIM.

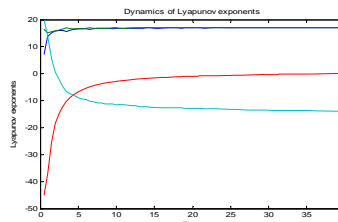

(b) Spectrum Lyapunov Exponent

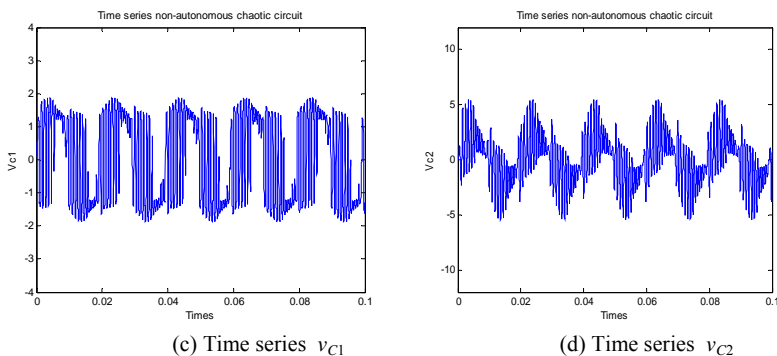

Fig.3 Numerical simulation results for  $f = 50$  Hz and  $v_m = 2$  volt

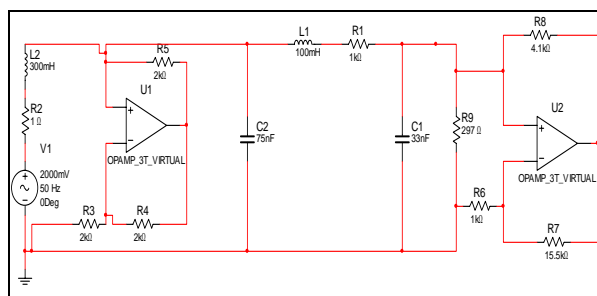

Fig.4 Implementation of non-autonomous chaotic circuit

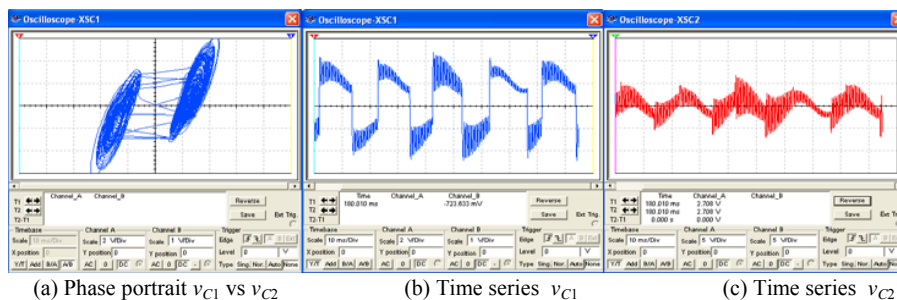

Fig.5 MultiSIM simulation results for  $f = 50$  Hz and  $v_m = 2$  volt

#### IV. BIDIRECTIONAL CHAOTIC SYNCHRONIZATION

Synchronization between chaotic systems has received considerable attention and led to communication applications. With coupling and synchronizing identical chaotic systems methods, a message signal sent by a transmitter system can be reproduced at a receiver under the influence of a single chaotic signal through synchronization. This paper presents the study of numerical simulation of chaos synchronization for chaotic non-autonomous fourth order attractor. Drive system and response system were constructed.

Synchronization of chaotic motions among coupled dynamical systems is an important generalization from the phenomenon of the synchronization of linear system, which is useful and indispensable in communications. The idea of the methods is to reproduce all the signals at the receiver under the influence of a single chaotic signal from the driver.

Therefore, chaos synchronization provides potential applications to communications and signal processing [8]-[12]. However, to build secure communications system, some other important factors, need to be considered. Simulations of synchronization of chaotic non-autonomous system are presented as shown in Fig. 6.

The control values  $v_m$  of the two systems are different, the control value  $v_m$  of the transmitter system is 2.001 volt, and the control value  $v_m$  of the receiver system is 2.000 volt. Simulation results show that the two systems synchronize well. Fig. 6 shows the circuit schematic for implementing the Synchronization of chaotic non-autonomous system. We use TL082CD op-amps, appropriate valued resistors, inductor and capacitors for MultiSIM® simulations. Fig. 6 also shows MultiSIM® simulation results of this circuit.

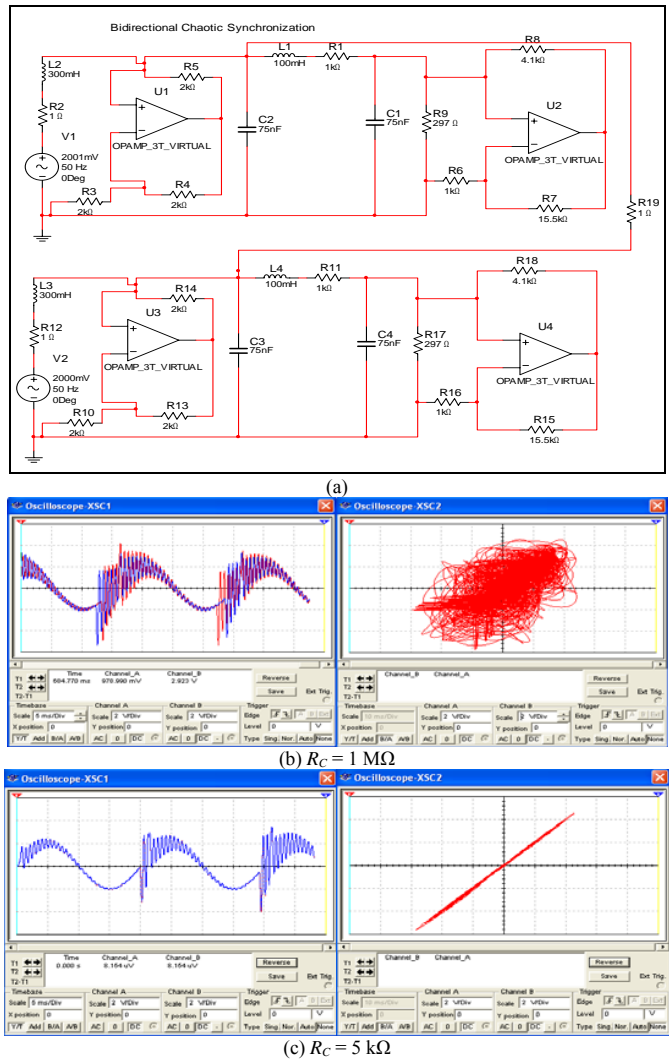

Fig. 6 MultiSIM<sup>®</sup> Circuit and simulations: (a) Synchronization of chaotic non-autonomous attractor Circuit; (b) Drive and response system chaotic signals before synchronization; and the phase portrait of unsynchronized case; (c) Drive and response system chaotic signals after synchronization; and X-Xr Synchronization

V. APPLICATION FOR SECURE COMMUNICATION SYSTEMS

Due to the fact that output signal can recover input signal, it indicates that it is possible to create secure communication for a chaotic system. The presence of the chaotic signal between the transmitter and receiver has proposed the use of chaos in secure communication systems. The design of these systems depends as we explained earlier on the self synchronization property of the chaotic non-autonomous attractor. Transmitter and receiver systems are identical except for their control value  $v_m$ , in which the transmitter system is 2.001 V and the receiver system is 2.000 V as shown in Fig. 6.

It is necessary to make sure the parameters of transmitter and receiver are identical for implementing the chaotic masking communication [8]-[12]. In this masking scheme, The square wave signals of amplitude 2V and frequency 0.5

kHz is added to the synchronizing driving chaotic signal in order to regenerate a clean driving signal at the receiver. Thus, the message has been perfectly recovered by using the signal masking approach through synchronization in the chaotic non-autonomous attractor. Computer simulation results have shown that the performance of chaotic non-autonomous attractor in chaotic masking and message recovery.

The square wave signal is added to the generated chaotic  $x$  signal, and the  $S(t) = x + i(t)$  is feed into the receiver. The chaotic  $x$  signal is regenerated allowing a single subtraction to retrieve the transmitted signal,  $[x+i(t)]-x_r = i'(t)$ , If  $x = x_r$ . Fig. 7 shows the circuit schematic for implementing the chaotic non-autonomous attractor's Chaotic Masking Communication. Fig. 8 shows MultiSIM<sup>®</sup> simulation results of this Chaotic Masking Circuit.

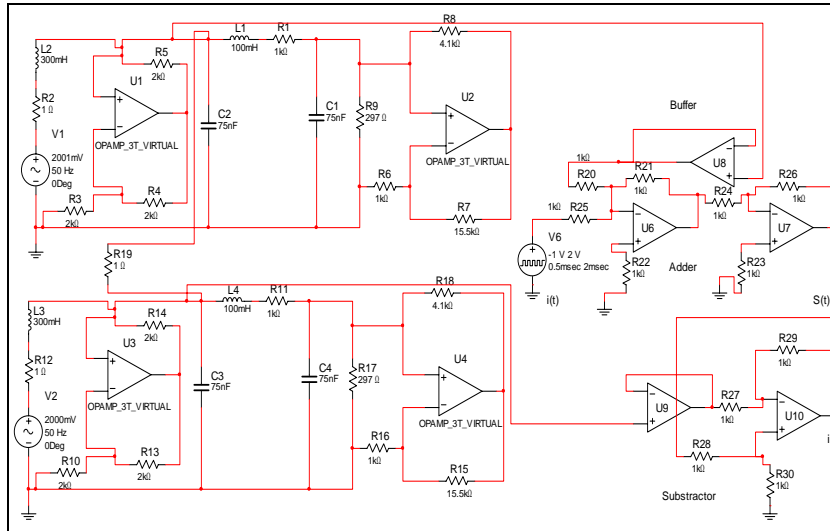

Fig. 7 Non-autonomous chaotic attractor masking communication circuit

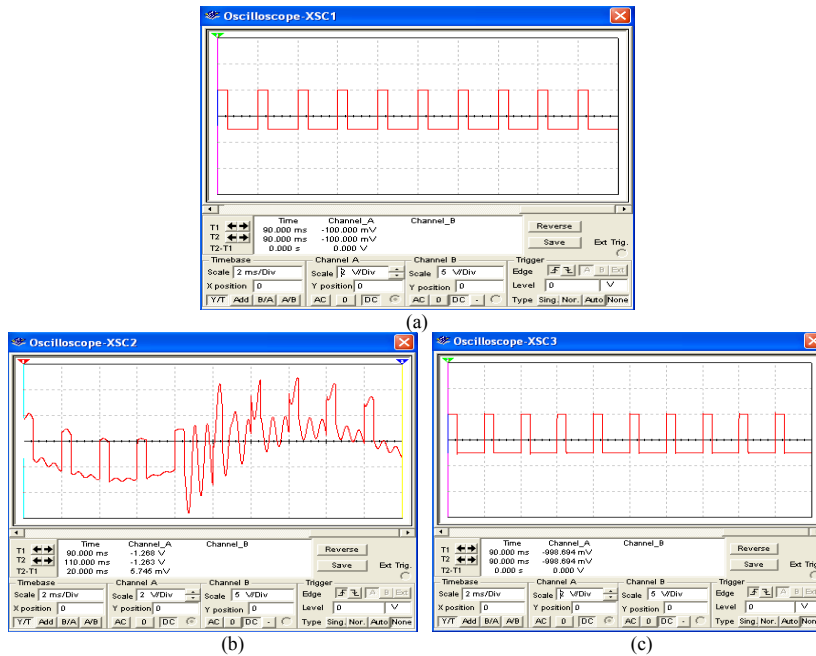

Fig. 8 MultiSIM® outputs of non-autonomous chaotic attractor Masking Communication Circuit: (a) Information signal  $i(t)$ ; (b) chaotic masking transmitted signal  $S(t)$ ; (c) retrieved signal  $i'(t)$

VI. CONCLUSIONS

This paper focuses on the chaotic oscillator circuit and the identical synchronization of the Fourth order non-autonomous chaotic attractor and its applications in signal masking communications. In this paper, non-autonomous chaotic circuit system is studied in detail by varying mostly the control parameter  $v_m$ . The system has rich chaotic dynamics behaviors. We have demonstrated in simulations that chaos can be synchronized and applied to secure communications. Chaos synchronization and chaos masking were realized using MultiSIM® programs.

REFERENCES

- [1] K.T. Alligood, T.D. Sauer, and J.A. Yorke, *Chaos: An Introduction to Dynamical Systems*, New York: Springer-Verlag, 1996.
- [2] H.C. Hilborn, *Chaos and Nonlinear Dynamics*, New York: Oxford University Press, 1994.
- [3] E.N. Lorenz, "Deterministic non-periodic flow," *Journal of the Atmospheric Sciences*, vol. 20, pp. 130–141, 1963.
- [4] O.E. Rossler, "An equation for continuous chaos," *Phys. Lett. A* 57, 397-398, 1976.
- [5] C.K. Volos, I.M. Kyprianidis, and I.N. Stouboulos, "Synchronization of two Mutually Coupled Duffing – type Circuits", *International Journal of Circuit, Systems and Signal processing*, vol.1(3), 274-281, 2007.
- [6] T. Matsumoto, "A chaotic attractor from Chua's circuit," *IEEE Trans. Circuits Syst.*, CAS 31(12):1055-1058, 1984.

- [7] M.P. Kennedy, "Robust Op Amp Implementation of Chua's Circuit," *Frequenz*, Vol.46, no.3-4, pp.66-80, 1992.
- [8] K.M. Cuomo, and A.V. Oppenheim, "Circuit implementation of synchronized chaos with applications to communications," *Physical Review Letters*, vol. 71, no. 1, pp. 65-68, 1993.
- [9] J. C. Feng, and C. K. Tse, *Reconstruction of Chaotic Signals with Applications to Chaos-Based Communications*. Tsinghua University Press and World Scientific Publishing Co. Pte. Ltd., 2007.
- [10] I. Pehlivan, and Y. Uyaroglu, "Rikitake Attractor and It's Synchronization Application for Secure Communication Systems," *Journal of Applied Sciences*, 7(2):232-236, 2007.
- [11] T. H. Lee, and J. H. Park, "Generalized functional projective synchronization of Chen-Lee chaotic systems and its circuit implementation," *International Journal of the Physical Sciences*, Vol. 5(7), pp. 1183-1190, July 2010.
- [12] I. Pehlivan, Y. Uyaroglu, and M. Yogun, "Chaotic oscillator design and realizations of the Ruckledge attractor and its synchronization and masking simulations," *Scientific Research and Essays*, Vol. 5(16), pp. 2210-2219, 18 August, 2010.
- [13] L. Pecora and T. Carroll, "Synchronization in Chaotic Systems," *Physical Review Letters*, Vol. 64, pp. 821-823, 1990.
- [14] L. Pecora and T. Carroll, "Driving systems With Chaotic Signals," *Physical Review Letters*, Vol. 44, pp. 2374-2383, 1991.
- [15] M.S. Papadopoulou, I.M. Kyprianidis, and I.N. Stouboulos, "Complex Chaotic Dynamics of the Double-Bell Attractor," *WSEAS Transactions on Circuit and Systems*, vol 7, pp 13-21, 2008.