

Assessment of Solid Insulating Material Using Partial Discharge Characteristics

Qasim Khan, Furkan Ahmad, Asfar A. Khan, M. Saad Alam, Faiz Ahmad

Abstract—In this paper, partial discharge analysis is performed in cavities artificially created in insulation. The setup is according with Cigre-II Method. Circular Samples created from Perspex Sheet with different configuration with changing number of cavities. Assessment of insulation health can be performed by Partial Discharge measurement as this has been found to be important means of condition monitoring. The experiments are done using MPD 540, which is a modern partial discharge measurement system. By analyzing the PD activity obtained for various voids/cavities, it is observed that the PD voltages show variation for cavity's diameter, depth even for its ratios. This can be employed for scrutiny of insulation system.

Keywords—Partial discharges, condition monitoring, MPD 540, cavities/defects, degradation and corrosion, PMMA.

I. INTRODUCTION

PARTIAL DISCHARGE (PD) measurement is an important and consistent, non-destructive method to analyzes Insulation health and testing of High Voltage Equipment [1]. In order to secure and efficient power supply, it is essential to have the insulators in a healthy condition during its operation [2], [3]. Due to the presence of cavity or voids or other impurities in insulators, the local electrical discharges also known as partial discharge (PD) takes place due to the high voltage stresses [4]. Electric discharges initiates between one or both electrodes and sound dielectric is present in the shape of a solid, liquid, or gaseous insulating material [5].

Partial Discharge is an adverse phenomenon which deteriorates insulation. Examples of this discharge are Internal Discharges, Surface discharges and Corona discharges [6]-[8]. Internal Discharges are discharges in cavities or voids present in the volume of the dielectric or in bubbles within liquid dielectrics. The electric stresses appearing across the void is considerably higher than surrounding dielectric due to the mismatch of the dielectric constant of the void and the surrounding dielectric [9], [10].

Surface Discharges are discharges occur on the surface of the solid insulation covered by the gas or liquid. PD can also occur along the periphery between different Insulating materials. Corona discharges occur in gases (or liquids) caused by locally enhanced field from sharp points. In this case, it is not the severe damage insulation, but the higher frequency disturbances arising out of these PDs, and quite often the energy dissipated (corona losses) together with its chemical aftereffects [8], [11].

Qasim Khan is with the Department of Electrical Engineering, Aligarh Muslim University, Aligarh, India (e-mail: qasim.rs@amu.ac.in).

II. PARTIAL DISCHARGE MEASUREMENT

The partial discharge (PD) terms to a discharge that partly bridges the electrodes [12]. As it impossible to prevent minor manufacturing flaws, cavities or non-homogeneities in the insulating material causing stress points. This stress points can lead to rising continuous local electric discharge, i.e. electric partial discharge. Formerly, the PD detection and measurements was performed on time base propagation fault location and known as efficient non-destructive method [13].

PD measurement can provide the Insulations deterioration and aging information [14], [15]. For online PD measurement, different requirements have to be fulfilled as compared to laboratory. Online partial discharge monitoring helps manufacturer to test power apparatus without taking it out of service, without overstress and less time. Online PD monitoring is the superlative means for the PD analysis efficiently [16], [17]. Today, onsite PD measurement techniques using suitable filtering and sensitivity with several Pico Coulombs (pC) are commercially available. The absolute magnitude of PD level itself is not as significant as that one from laboratory measurements. Even more remarkable is the location of PD sources. In most cases, the PD does not outcome from the internal cable insulation, but from the accessories like joints and terminations. Therefore, the source location becomes more important. With PD measurement, one can check local deterioration of insulator or electrical trees that lead to emerging faults [18], [19].

The MPD 540 (mtronix, [20]) is one of the digital partial discharge measuring system. This measurement system includes one or more acquisition units (Fig. 1), an optical interface (fibre optic USB controller) and a PC including measuring software.

The PD signals are filtered, amplified, and digitized. MPD have an amplitude quantization of 14 bit, detection accuracy of a PD signal is at about 2 ns and a sampling rate of 64 MS/sec. The quasi-integration is realized by a digital bandpass filter.

III. EXPERIMENTAL SETUP

A. Sample Preparation

The tests have been carried out according to IEC standard [12] for insulation materials. The test sample is prepared from Poly-methyl methacrylate (PMMA) also known as Perspex sheet of different thickness. Circular sample are cut from perspex sheet with the help of lathe machine of same diameter according to electrode employed. Perspex sheet circular sample with four different thicknesses are chosen. After that, cylindrical cavities of different diameter and Depth are drilled on the Circular Insulation sample with the specified spacing. Cavity dimension varied in

order to simulate the defects and void found in insulation. Fig. 2 show the prespex disc with 4 artificially created cavity with spacing of 4mm from each other.

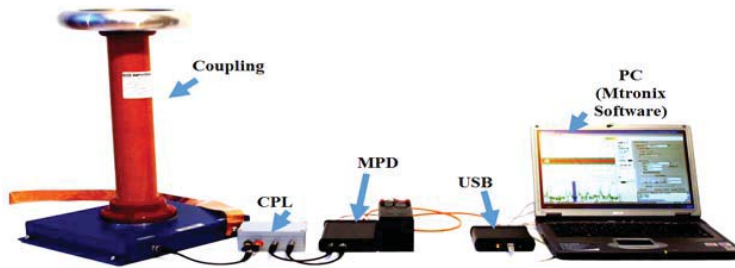

Fig. 1 Test setup for investigation of partial discharge in a cavity

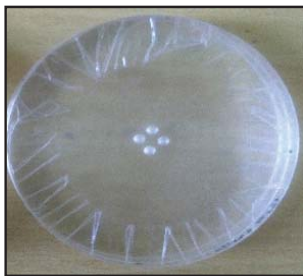

Fig. 2 Test Sample of PMMA Sheet with four cavities

A sample is arranged by pack in the disc with the artificial cavity (or cavities) between two discs having no irregularity. After that, adhesive tape is wrapped around the circumference of the assembly of three discs with extreme care so that no air-gap was left at the interfaces of the discs. Thus, samples are well-found for partial-discharge testing.

Fig. 3 shows the CIGRE Method II electrode system used in experiments. It is an improved type of CIGRE Method I (CM-I) electrode and is accepted by CIGRE SC15 as a standard test

electrode for internal PD measurements. The electrode system includes a brass rod which acts as high voltage electrode, cast epoxy resin (i.e. araldite) with central holed as a guard insulator for support. The high-voltage electrode is fitted centrally. A brass cylindrical rod is carved into disc shaped with the necessary arrangement for connection to the ground. This ground electrode has threading at its center up to approximately half of its depth so as to fix it at the rod.

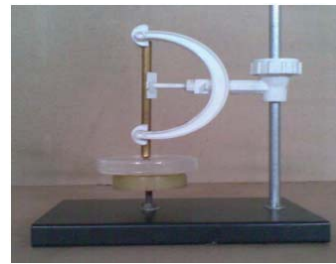

Fig. 3 Cigre Method-II Electrode system

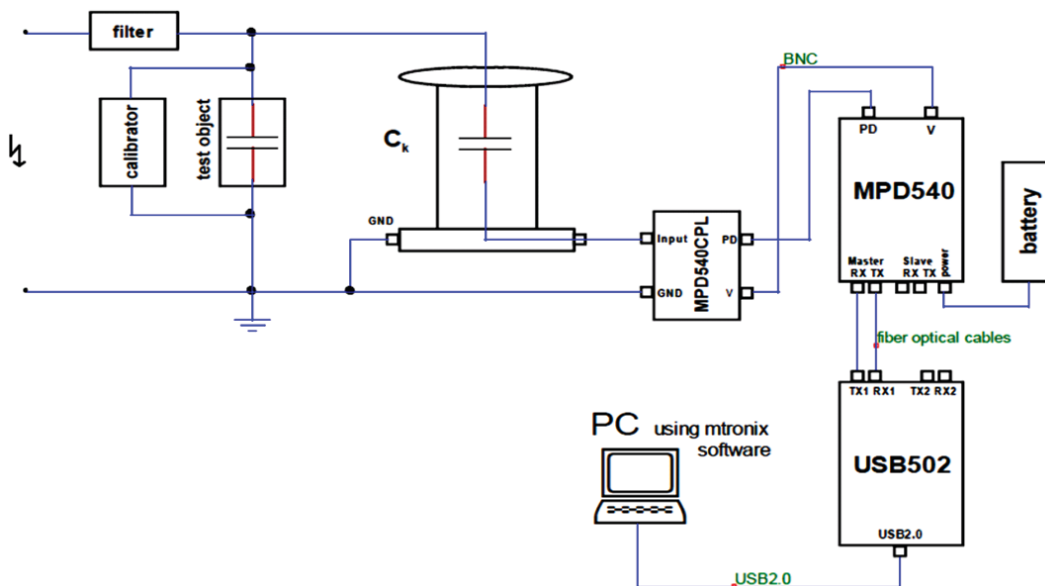

Fig. 4 Measurement circuit for PD Measurement system

A. Digital Pd Measurement System

MPD540 Partial Discharge Analysis toolkit is implemented for detecting, data recording, and analyzing partial discharge parameters during experiment. The Centre frequency value in Mtronix software is selected as 350 KHz, the bandwidth 300 KHz, respectively. The arrangements of apparatus are according to experiment circuit given in Fig. 4. Electrodes are made smooth to reduce corona from the experiment. During the experiment, applied voltage is first gradually increased up to twice of Approx. PDIV and then gradually decreased. Duration of PD recording for n-q-p plots at each voltage level must be adequate. The test voltage signal is recorded during the PD measurement to determine various PD features. In order to reduce the influence of surface discharge, the sample must be clamped by electrodes.

IV. RESULTS

Number of experiment is performed using sample of multi-cavities with different dimension. Fig. 5 shows the shifting of PD parameters over sample thickness. The results presented in this paper correspond only to the impact of electric field on the dielectric surface of the insulating materials depending on the geometry of the void/defect and the nature of the dielectric. Parameters in Fig. 6 correspond to an applied voltage peak to the test cell for all sample cavities (1 cavity, 2 cavities, 3 cavities, 4 cavities, 5 cavities).

In the beginning, partial discharges start at lower voltage levels. The Inception (PDIV) and Extinction voltages (PDEV) increased almost gradually with thickness of sample respectively. As we increasing number of cavities, the PD voltage goes decreasing as well.

The similar trend in PD parameter is shown in Fig. 6. It represents the relation between PD voltages and cavity depth. The inception voltage increases with increase in cavity depth for a given diameter of the cavity. [21] For internal discharges, the voltage, which must be applied to the insulation for initiating discharges in case of a single cavity system, is given as

$$Vi = \frac{Eg*[t+t'(\epsilon-1)]}{\epsilon} \tag{1}$$

where E_g is the electric strength of air gap at pressure p , t' denotes the thickness of the discharge gap included with the thickness t of insulation and ϵ denotes the dielectric constant. Figs. 7 and 8 show the variation of inception voltage and extinction voltage respectively. For constant diameter of the cavity if diameter to cavity depth (d/t') ratio is increased, both the inception voltage and extinction voltage decrease. This clearly shows that discharge inception in insulation depends not only on the size of the cavities present but also on the ratio of cavity diameter to cavity depth. As this ratio increases, the insulation is more prone to failure at higher voltages.

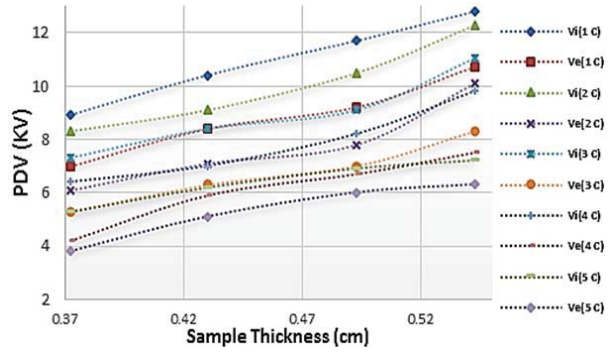

Fig. 5 PD Voltages of the samples with 1-5 cavities for varying thickness

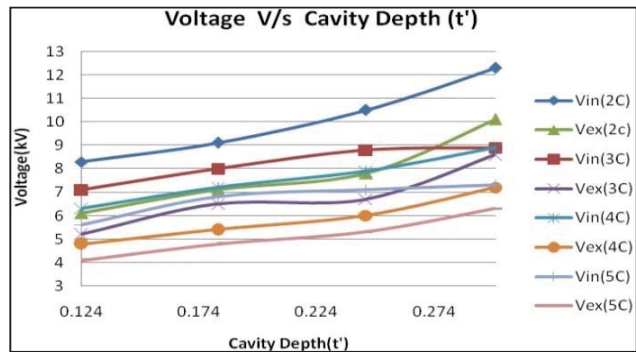

Fig. 6 PD Voltages of samples with 1-5 cavities for varying cavity depth

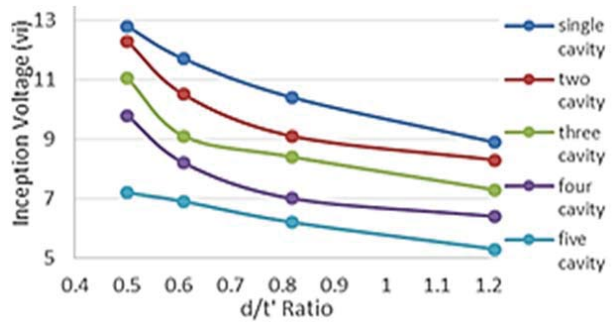

Fig. 7 PD Inception Voltages of the samples with 1-5 cavities for varying its ratio

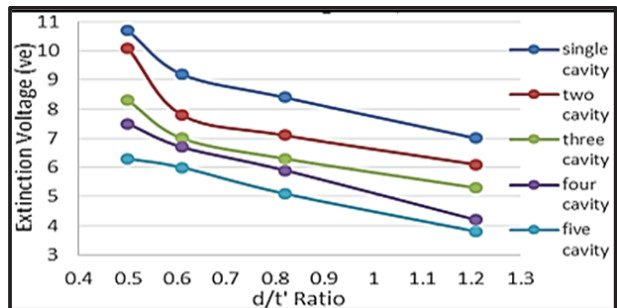

Fig. 8 PD Extinction Voltages of the samples with 1-5 cavities for varying its ratio

V.CONCLUSION

Cavities are investigated. The experimental work shows that the air voids, depth of voids, thickness of sample and diameter of the cavity plays the very vital role for the partial discharge. At first, for a given depth of the cavity and overall thickness of the sample if diameter of the cavity increases, the inception voltage decreases. This confirms that wider cavity formation in the insulating medium is more dangerous than a thinner one.

PDIV and PDEV increases with increase in cavity depth for a given diameter of the cavity which indicates that insulating medium having longer cavities parallel to the electric field are less dangerous and can be used for higher working stress, It is identified that discharge voltages in insulation depends not only on the size of the cavities present but also on the ratio of cavity diameter to cavity depth. As this ratio increases, the insulation is more prone to failure at higher voltages.

The results are telling of the fact that defects or cavities beyond a certain size (a particular diameter to cavity depth ratio) affects the partial discharge parameters for any insulation and discharge in the cavity does not tend to extinguish even for much less extinction voltage i.e. there is a tendency of discharge to persist.

REFERENCES

- [1] R. Liao, Y. Fernandess, K. Tavernier, G. A. Taylor, and M. R. Irving "Recognition of Partial Discharge Patterns", IEEE Power and Energy Society General Meeting, pp.1-8, 2012.
- [2] F. H. Krueger, *Discharge detection in high voltage equipment*. Temple Press Books Ltd, London, 1964.
- [3] S. Whitehead, *Dielectric Breakdown of Solid*, Chapter 4 "Breakdown caused by Discharges", Oxford, Clarendon Press, UK, 1950.
- [4] R. Bartnikas, "Partial Discharges: Their Mechanism, Detection and Measurement", IEEE Trans. Dielectr. Electr. Insul., Vol. 9, No.5, pp.763-808, 2002.
- [5] F. H. Kreuger, "Partial Discharge Detection in High-Voltage Equipment," Butterworths, 1989
- [6] A. Haddad and D. Warne, eds. *Advances in High Voltage Engineering*, Chapter 4 "Partial Discharge and their Measurement", IEE, UK, 2004.
- [7] F. H. Kreuger, E. Gulski and A. Krivda, "Classification of Partial Discharges", IEEE Trans. Dielectr. Electr. Insul., Vol. 28 No. 6, pp. 917-931, 1993.
- [8] P. H. F. Morshuis, "Partial discharge mechanisms," PhD dissertation, Dept. Electr. Eng., Delft Univ., Delft, the Netherlands, 1993.
- [9] P. H. F. Morshuis, "Degradation of solid dielectrics due to internal partial discharges: Some thoughts on progress made and where to go now," IEEE Trans. Dielectr. Electr. Insul., vol. 12, pp. 905-913, 2005.
- [10] P. Morshuis, "Assessment of Dielectric Degradation by Ultra-wideband PD Detection", IEEE Trans. Dielectr. Electr. Insul. , Vol. 2, pp. 744-760, 1995.
- [11] M.H. Nazemi, V. Hinrichsen, "Experimental Investigations on Water Droplet Oscillation and Partial Discharge Inception Voltage on Polymeric Insulating Surfaces under the Influence of AC Electric Field Stress", IEEE Trans. Dielectric Insul., Vol. 20, No.2, pp. 443-453, 2012.
- [12] IEC Standards 60270, Partial Discharge Measurements, 2000.
- [13] J. Li, W. Si, X. Yao and Y. Li, "Partial Discharge Characteristics over Differently Aged Oil/pressboard Interfaces", IEEE Trans. Dielectr. Electr. Insul., Vol. 16, No. 6, pp. 1640-1647, 2009.
- [14] A. Bui, A. Khedim, A. Loubière, and M. B. Kourdi, "Aging of zinc oxide varistors subjected to partial discharges in sulfur hexafluoride." *J. Appl. Phys.*, Vol. 69, pp. 1036-1040, 1991.
- [15] L. Testa, S. Serra, and G. C. Montanari, "Advanced modeling of electron avalanche process in polymeric dielectric voids: Simulations and experimental validation," *J. Appl. Phys.*, Vol. 108, pp. 1-10, 2010.
- [16] S. Jones, A. Kingsmill, M. Blundell, J.Gabb and G. Slade, "On-line condition monitoring of high voltage equipment in two transmission networks in australia", International Conference on Large Electric systems, Queensland, Australia-2006.
- [17] R. Ambikairajah, B.T. Phung, J. Ravishankar, T. R. Blackburn and Z. Liu, "Smart sensors and online condition monitoring of high voltage cables for the smart grid", International Middle East Power Systems Conference , Sidney, Australia, December 19-21, 2010.
- [18] F.Garnacho, I.Trasmonte et al., "On-site measurements experiences in insulation condition for medium and high voltage cables", CIGRE, D1-201, 2008.
- [19] Standard for Partial Discharge Test Procedure, Publication ICEA T-24-380, 2006.
- [20] Mtronix: Advanced PD Analysis System MPD 540, "Product Brief and Technical Specification," Berlin,Germany, 2004.
- [21] M.S. Naidu, and V. Kamraju, *High voltage engineering handbook*, 4th Edition TMH Publishers, 2006.