

Artificial Neural Network Modeling and Genetic Algorithm Based Optimization of Hydraulic Design Related to Seepage under Concrete Gravity Dams on Permeable Soils

Muqdad Al-Juboori, Bithin Datta

Abstract—Hydraulic structures such as gravity dams are classified as essential structures, and have the vital role in providing strong and safe water resource management. Three major aspects must be considered to achieve an effective design of such a structure: 1) The building cost, 2) safety, and 3) accurate analysis of seepage characteristics. Due to the complexity and non-linearity relationships of the seepage process, many approximation theories have been developed; however, the application of these theories results in noticeable errors. The analytical solution, which includes the difficult conformal mapping procedure, could be applied for a simple and symmetrical problem only. Therefore, the objectives of this paper are to: 1) develop a surrogate model based on numerical simulated data using SEEPW software to approximately simulate seepage process related to a hydraulic structure, 2) develop and solve a linked simulation-optimization model based on the developed surrogate model to describe the seepage occurring under a concrete gravity dam, in order to obtain optimum and safe design at minimum cost. The result shows that the linked simulation-optimization model provides an efficient and optimum design of concrete gravity dams.

Keywords—Artificial neural network, concrete gravity dam, genetic algorithm, seepage analysis.

I. INTRODUCTION

BUILDING of a water retaining structure, such as a concrete gravity dam is an effective solution for the dealing with water crisis and to provide safe and strong water resource management. Three main factors must be considered in the design of the concrete gravity dam: 1) construction cost, because the building of such a structure is expensive, 2) safety, because any failure will lead to catastrophic events and 3) accurate seepage analysis, because seepage analysis is challenging, especially for complex problems.

The mathematical relationship of seepage characteristics is complex, nonlinear, and discontinuous [1]. The complexity arises from several factors, such as: 1) the governing equation, which is a second order partial differential equation, 2) the geometry of the flow domain under a hydraulic structure, and 3) the soil properties and boundary conditions.

Muqdad Al-Juboori (PhD candidate) is with the Collage of Science and Engineering, Civil Engineering, Hydraulic structure, James Cook University, Townsville QLD 4811, Australia (e-mail: muqdad.aljuboori@my.jcu.edu.au).

Bithin Datta (Theme Leader) is with the Water Quality and Contamination, TropWATER – Centre for Tropical Water and Aquatic Ecosystem Research, Research, James Cook University, Townsville QLD 4811, Australia (e-mail: bithin.datta@jcu.edu.au).

Although an analytical solution, which is generally based on many approximation assumptions, is suitable for simple and symmetrical cases, it is impossible to apply to more complex cases. Therefore, different approximation theories have been developed for the seepage analysis. However, the application of these theories is accompanied by non-trivial errors. This was demonstrated by Shahrbanozadeh et al. [2] when they compared the performance of the seepage parameter calculated by an experimental model and different methods such as Blight's (1915), Lane's (1935), Khosla's (1936) Iso-Geometric Analysis (IGA) method and Finite Element Method (FEM). The results showed that the IGA and FEM provide an excellent estimation of seepage parameters compared to the experimental observation. Consequently, numerical methods such as FEM have been used by: [2]-[8] and [2] to provide a precise seepage analysis for more complex problems. Accordingly, the FEM is used in this study to simulate numerous scenarios with different design parameters. Recently, several codes have been developed based on FEM, such as Geo-Studio/SEEP/W[®] [9], which provide accurate simulation for complex problems with variable design parameters and boundary conditions.

Although numerical methods provide a precise estimation for the seepage analysis, these methods cannot explicitly address the important factors of safety and cost of the hydraulic structure design in its simulation and design. Therefore, there is a need for developing a methodology to precisely analyze seepage related to a concrete gravity dam and explicitly incorporate safety and cost concepts in the design of the structure. This could be achieved by using linked simulation optimization models based on a surrogate model. One of the widely used method to build a surrogate model is the Artificial Neural Network (ANN) [10]-[13]. After a surrogate model is successfully trained by utilizing simulated data, it can be used as an approximate simulator and to analyze the seepage problems. Furthermore, the surrogate model could be linked to the optimization model [14]-[20] by using Genetic Algorithms (GA) [21], [22], [13] and based on accurate estimations of seepage solutions to find the optimum design regarding safety and cost. By using this methodology, the previously mentioned three most important design aspects could be incorporated in the optimum design of the concrete gravity dam. Therefore, the objective of this study is to develop a suitable surrogate model for seepage analysis and

link this model to the optimization model to improve the hydraulic design related to seepage of a concrete gravity dam in regarding the safety and cost.

II. MATERIAL AND METHODOLOGY

A. Geo-Studio Model /Finite Element Method (FEM)

Geo-Studio software is a FEM approach to solve the governing (Laplace) seepage equation, which is a complex partial differential equation describing seepage performance. However, all equations of FEM are formulated at element nodes. The equation factors change at each node based on location, properties and boundary condition of the nodes, which in turn represents the surrounding elements [9]. The general finite element transient seepage equation is given by (1):

$$[K] + [M]\{H\},t = \{Q\} \quad (1)$$

where $[K]$ = the element characteristic matrix, $[M]$ = the element mass matrix, $\{Q\}$ = the element applied flux vector, $\{H\}$ = the vector of nodal heads, t =time.

For steady state seepage, the terms $\{H\}$, t vanish, then the finite element equation is expressed as: $[K]\{H\} = \{Q\}$

The Gaussian numerical integration is used in SEEP/W to evaluate an element characteristic matrix $[K]$. For example, the integral form of $[K]$ matrix is given by (2):

$$[K] = \tau \int_A [B]^T [C] [B] dA \quad (2)$$

where $[B]$ = the gradient matrix, $[C]$ =the element hydraulic conductivity matrix, τ = the thickness of an element, A = the area of the element [23].

B. Characteristics of the Numerical Model

The numerical model shown in Fig. 1 is built to correspond to many aspects and to provide a generalized applicable model. For instance, input design variable d_1 (depth of sheet pile on upstream) and d_2 (depth of sheet pile on downstream) are assumed as 1-40 m, and the width of hydraulic structure b is assumed as 2-120 m. To satisfy an unconfined seepage flow condition, the underneath soil layer thickness is assumed as 140 m, which is more than the maximum value of $b=120$ m and the width of flow domain is 180 m.

Since most permeable soils are weak soils when faced with tremendous hydraulic pressure, [24] recommended that the maximum water height for a gravity dam on permeable soil should not exceed 40 m. Therefore, the range of head is assumed between (1-40 m). Moreover, [25] recommended to place the major portion of a dam floor within the upstream side. The increase of the floor portion (b^*) in the upstream side corroborates the stability of dam, where the upstream hydrostatic pressure and the weight of the floor counterbalances the substantial uplift pressure on the foundation of the dam, as shown in Fig. 6. Homogenous and isotropic hydraulic conductivity (k) is considered in this study ($k=5 \times 10^{-5}$ m/s).

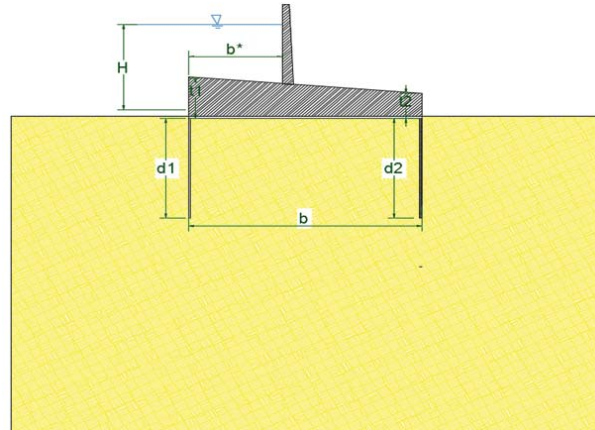

Fig. 1 Assumed numerical SEEP/W model

C. Data Generation

Training of the surrogate model is based on simulated data generated by solving the numerical seepage modeling software SEEP/W. For each scenario, the independent variables (d_1 , d_2 , b) are randomly generated by using the Latin Hypercube Sampling method (LHS). LHS is a statistical method to randomly generate points, with each set of points giving the local periodic information that facilitates building an efficient experience of the machine learning about the change of input data and its effects on the output data [26]. The output data are the results from numerical seepage modeling for each scenario, which represent: the θC (uplift pressure near the upstream sheet pile), θE (uplift pressure near downstream) sheet pile and (i_e) exit gradient at dam toe.

D. ANN Description

A typical simple neural network consists of input layer, hidden layer(s) and output layer. As shown in Fig. 2 the circles represent the neurons, lines between layers represent the weights or connection strength and X and Y vectors represent input and output data, respectively [27].

ANN tests all input and output data and learn using ANN learning rules about how the change in the input datasets impact on the output data set. The objective function of the ANN training algorithm (Liebenberg-Marquardt) is to minimize the error between ANN output and the target data and to present the best fitting weighted factors corresponding to the variable vector [28]. The mean square error (MSE) is computed by using (3):

$$MES = \frac{\sum_{i=1}^N (y_g - y_o)^2}{N} \quad (3)$$

where: Y_g = the target data, Y_o = the output data of ANN and N is number of scenarios [28]. In this study, a supervised training algorithm is applied using Liebenberg-Marquardt with backpropagation error. The three input data (d_1 , d_2 , b) and the three output data (θC , θE , i_e), with 508 different scenarios are processed through the ANN model to train a surrogate model. Input data pass through the input layer, and the training operations are processed in the forward direction,

then the outcomes of the output layer are compared with target values. The errors between ANN output and target values are distributed back on the weight factors to modify its values. Errors in back propagation are repeated numerous times until the convergence is achieved between output data and target data [27].

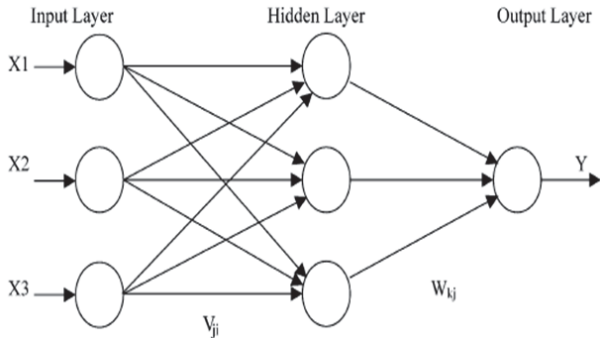

Fig. 2 Typical ANN model

The example of the mathematical expression of ANN which has: one hidden layer (h), (s) hidden neurons, (i) input variables, (m) output variables and (p) input-output datasets, is given as (4):

$$Y_{pm} = f_1 \left[\sum_{j=1}^m W_{mj}^o f_2 \left\{ \sum_{i=1}^s W_{si}^h x_{pi} + b_s \right\} + b_m \right] \quad (4)$$

where Y_{pm} is the output of ANN, x_{pi} is the input variables, W_{jk}^o = connection weight factors between j node of hidden layer and k node of output layer, W_{ij}^h = the connection weighted factors of for (i) input variable and (j) node of hidden layer.

In this research, the developed ANN model has nine hidden neurons in one layer, as shown in Fig. 5. Additionally, the **Tansig** transfer function (*Hyperbolic tangent sigmoid* $a = 2/(1+\exp(-2*n))-1$) is used between the input layer and hidden layer, while **purelin** ($a = \text{purelin}(n)$) is used between the hidden layer and output layer, as shown in Figs. 3 and 4.

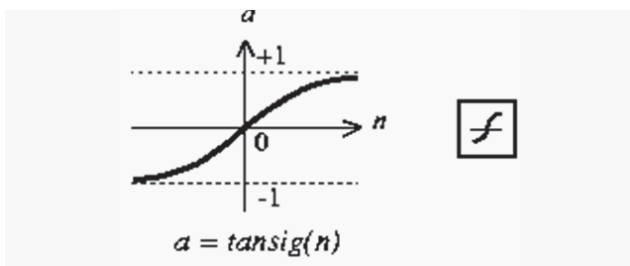

Fig. 3 Tan -sigmoid transfer function

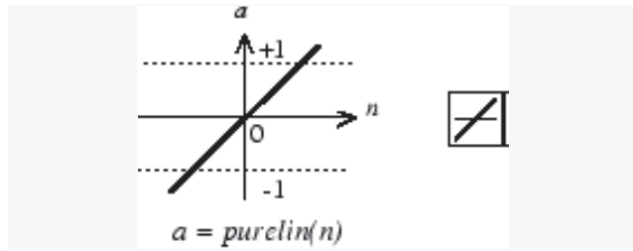

Fig. 4 Purelin transfer function

The simulated data are divided into three categories: 1) 55% for training data from which the ANN learning process is executed, 2) 20% for validation to measure how much the ANN results are convergent with target data and by which the ANN performance could be improved and, 3) 25% for testing data independently after the training is finished. Moreover, the testing phase prevents overfitting learning and ensures ANN generalization with the detached data. However, the testing process is generally test the ANN performance.

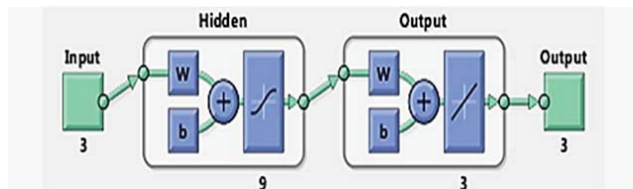

Fig. 5 Architecture of ANN

E. Optimization Model

The optimization model was formulated to find a safe and minimum cost seepage design related to a concrete gravity dam that impounds a significant amount of water. The main optimization components are summarized as follows:

1. Decision (Or Design) Vector

Design vector $X = \{x_1, x_2, x_3, x_4\}$ where:

- $x_1 = (d_1)$ =upstream sheet pile depth (m)
- $x_2 = (d_2)$ =downstream sheet pile length (m)
- $x_3 = (b)$ the width of hydraulic structure(m)
- $x_4 = (b^*)$ the portion of the floor at upstream (m)

2. Objective Function

The objective function is defined by (5):

$$\text{Minimize: } f(x) = C_1 V_1 + C_2 V_2 + C_3 V_3 \quad (5)$$

where: $f(x)$ = the objective function, which represents the construction cost seepage control elements of the concrete gravity dam. The objective function incorporates the decision variables and design parameters, where V_1, V_2 are the volume (m^3) of the upstream and downstream sheet pile, respectively. V_3 = Volume of dam floor (m^3)

C_1, C_2 are the construction cost of upstream and downstream sheet piles per unit volume, respectively, which can be expressed by (6), (7) as a function to depth (x_1, x_2).

$$C_1 = 0.9x_1^2 + 60x_1 + 120 \quad (6)$$

$$C_2 = 0.9x_2^2 + 60x_2 + 120 \quad (7)$$

C_3 = construction cost of floor per unit volume (assumed as \$400 for this illustrative study)

3. Constraints

Constraints are physical conditions or design requirements, and the optimal design must satisfy these conditions. The design of a concrete gravity dam has many requirements and conditions that are formulated as constraints in an optimization model, as shown by:

a) Flotation Constraint

The standard stabilization requirements of hydraulic structures against uplift pressure was provided by the U.S. Army Corps of Engineers [29]. They recommended a minimum safety factor for uplift pressure (flotation forces) of a hydraulic structure under normal operating conditions as 1.5, while, for construction and maintenance conditions with zero water level, the minimum safety factor for uplift pressure is 1.3. Therefore, the upstream and downstream uplift pressure must be less than the unite weight of the concrete floor (t_1) plus hydrostatic pressure, as shown in Fig. 6.

b) Exit Gradient Constraint

The exit gradient value is one of the most crucial seepage characteristics to ensure design safety. Physically, the exit gradient can be represented by the head decrease at the last square of the stream-equipotential grid near ground surface divided by the length of this square ($i_c = \Delta h/L$). The safety factor is computed by (8):

$$F.S = \frac{i_c}{i_e} \quad (8)$$

where $i_c = \frac{\gamma_{sub}}{\gamma_w}$ or $i_c = \frac{(\gamma_s - 1)}{(1 + e)}$

According to [1], [30], the minimum safety factor for the exit gradient is 5, as the soil properties considered are for dense sand (Mixed grained sand, $\gamma_{sat} = 21.2 \text{ kN/m}^3$)[31].

c) Sliding Constraint

Dam resistance must be sufficient against sliding and the shear forces elaborated along the contacted surface between the dam and the soil foundation or any horizontal joint within the dam body. To examine the safety of a structure against sliding, two factors must be estimated: the cohesion (C) factor and internal friction resistance factor ($f = \tan\phi$), where ϕ is an internal soil friction angle. However, [24] recommended for normal load conditions, the sliding safety factor (Ks) is 1.5, which can be determined by (9):

$$K_s = \frac{\sum V \tan\phi + cB}{\sum W} \quad (9)$$

where, K_s = sliding factor of safety, $\sum W$ =resultant of horizontal forces acting on dam, $\sum V$ = resultant of all vertical forces, C =cohesion resistance soil properties, B =width of structures, ϕ =internal friction angle, the values of $f=0.7$ and $C=20 \text{ kPa}$ are assumed according to [24].

d) Over Turning Constraint

The overturning stability is another important concept in dam design. According to the US Army Corps Engineers [32] recommendation, the resultant force location for normal conditions must be within the middle third of the foundation width. This condition corroborates a full compression zone under the dam foundation and prevents the probability of a tension zone. Resultant location (e) = $\sum M / \sum V$ where: $\sum M$ = is the resultant of all Moment around toe, $\sum V$ = is the resultant of Vertical forces acting on the dam, On the other hand, Lj [24] recommended the safety factor design against overturning (F_{ovt}) be not less than 1.5. This value is given as:

$$F_{ovt} = M_{pas} / M_{act}$$

where; M_{pas} = passive moments which stabilize the dam (about toe), M_{act} = active moments which weaken the stability of the dam (about toe).

e) Other Hydraulic Constraints

Lj [24] mentioned that the minimum distance between two sheet piles is not less than the summation of sheet pile lengths. Moreover, the range of sheet pile length is less than 1.5 times of the total head.

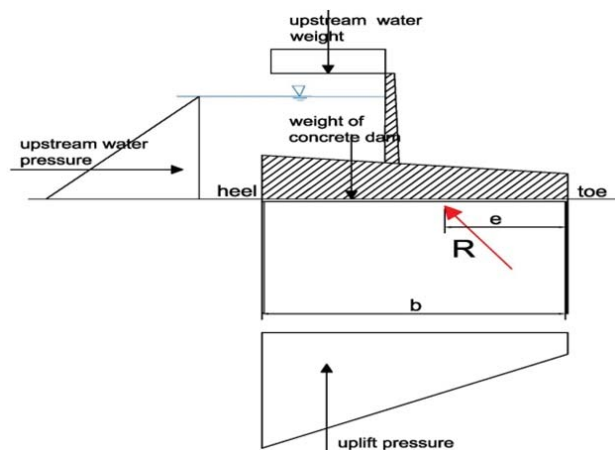

Fig. 6 Load and forces diagram on dam

F. Genetic Algorithm (GA)

GA is an effective global optimization algorithm. GA is used when the objective function or constraints expression is highly nonlinear, stochastic and has undefined derivatives, such as the ANN code-function [33]. Therefore, ANN function cannot be used with traditional optimization algorithms. GA invokes the ANN function an enormous number of times to be able to compare the selected solution with fitness value and the constraints. These processes continue until best fitness function is achieved. GA-ANN linking is processed with the objective function or/and constraints.

TABLE I
ANN REGRESSION CORRELATION COEFFICIENT (R) AND MEAN SQUARE
ERROR (MSE)

	Samples No.	MSE (mean square error)	R regression
Training	279	2.02061e-3	0.995348
Validation	102	1.89261e-3	0.995285
Testing	127	2.19903e-3	0.994673

III. RESULT AND DISCUSSION

A. ANN Results

The trained ANN provided an excellent regression correlation coefficient, and mean square error (MSE) is also small, as shown in Fig. 7 and Table I. The ANN responses were saved as a function code in MATLAB, and used as a simulation model (surrogate model) to determine seepage parameter. The surrogate model was linked to an optimization model to incorporate cost, safety concepts, and accurate seepage analysis related to the design of a concrete dam.

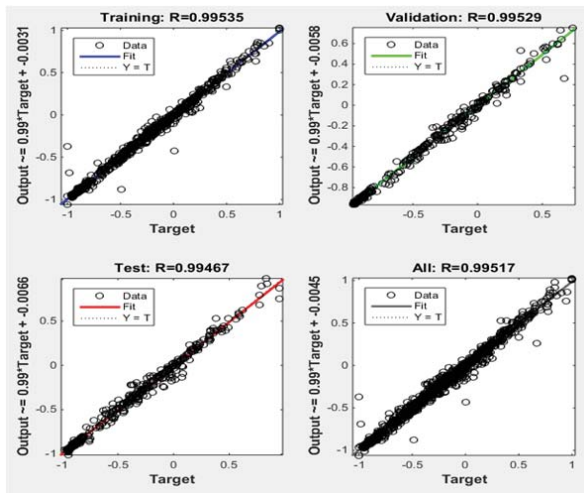

Fig. 7 ANN learning correlation regression coefficient learning validation test

B. Simulation–Optimization Results

The simulation–optimization model was implemented with 40 different heads (h) ranging from (1-40 m) to find design

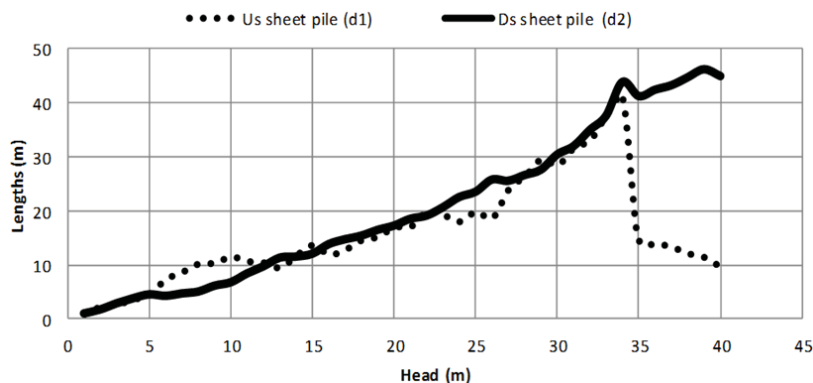

Fig. 8 Optimum solution for upstream (Us) and downstream (Ds) sheet pile lengths

variables and design parameters with the minimum cost objective function. Design requirement of the concrete gravity dam and all constraints were satisfied for each specified scenario.

The results showed that the dominant factor of optimization was the exit gradient safety factor, which reached the maximum value (0.23) to satisfy at least five times more safety than critical exit gradient (1.15), as shown in Fig. 10. This explains that the exit gradient safety factor has an extreme impact on the optimization process and in turn the cost of the structure. Moreover, the width of the concrete dam in most cases yields to the minimum constraint limits, because the minimum length of **b** should be no less than the sum of the two sheet piles' length. That is logical, as the upstream and downstream thicknesses (t_1 , t_2) of the floor are extremely expensive, where the upstream and downstream thickness reaches to 30 and 20 m, respectively, as shown in Figs. 8 and 9.

When the upstream head reaches 35 m or more, the increase of first sheet pile depth does not play as significant a role in reducing the exit gradient and uplift pressure at the downstream sheet pile as does the downstream sheet pile. Additionally, the construction cost of the cut-off is a function of depth and increases dramatically with the increase in depth. Accordingly, the optimization process decreases the length of upstream sheet pile, and increases the width of the dam (**b**) and the downstream sheet pile to reduce the uplift pressure at θE . In turn, it reduces the exit gradient; consequently, the cost is less, as shown in Figs. 8 and 9.

Additionally, when the optimization results were evaluated by utilizing the SEEP/W and Khosla's theory based solutions, a convergence with respect to uplift pressure values and exit gradient values were demonstrated, as shown in Figs. 10 and 11. Nonetheless, there were a few exit gradient values that had a slight deviation and did not satisfy the safety factor up to five times the critical exit gradient, as shown in Fig. 10. This could be attributed to the weak ANN learning for the variable located beyond the assumed ranges which is used for training. In addition, it was due to some assumptions utilized in Khosla's theory regarding the sheet piles' correction interface, and for the exit gradient formula.

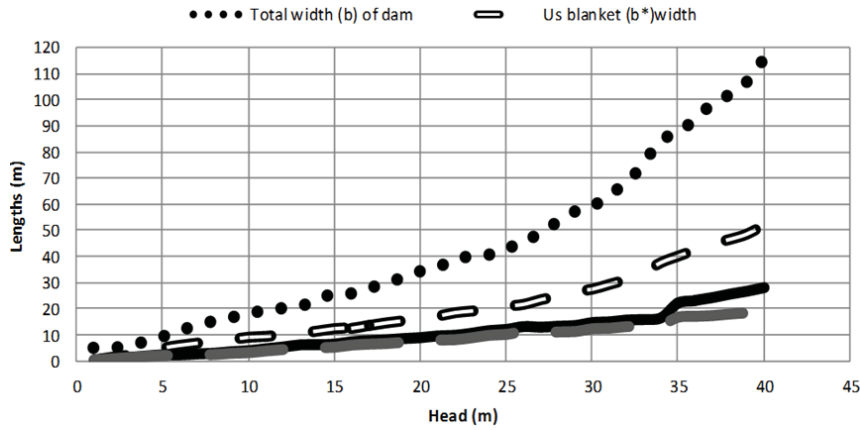

Fig. 9 Optimal solution of (b, b*, t₁, t₂)

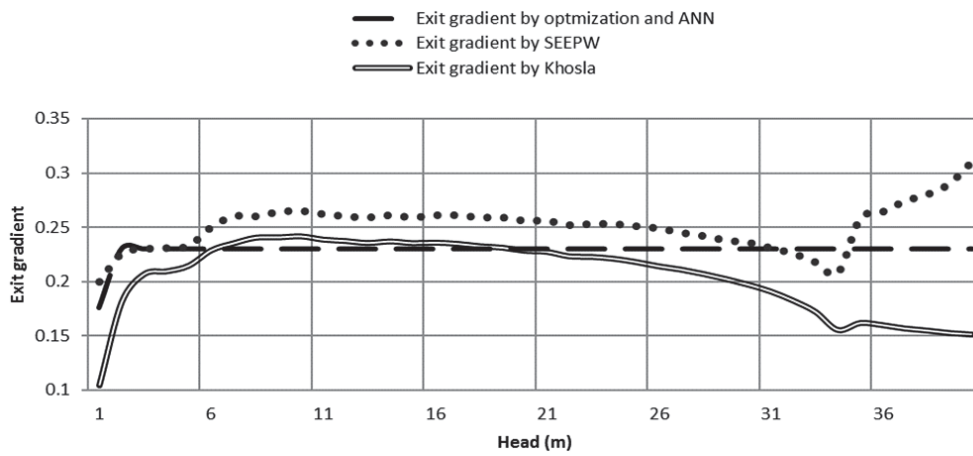

Fig. 10 Comparison of exit gradient result using different methods

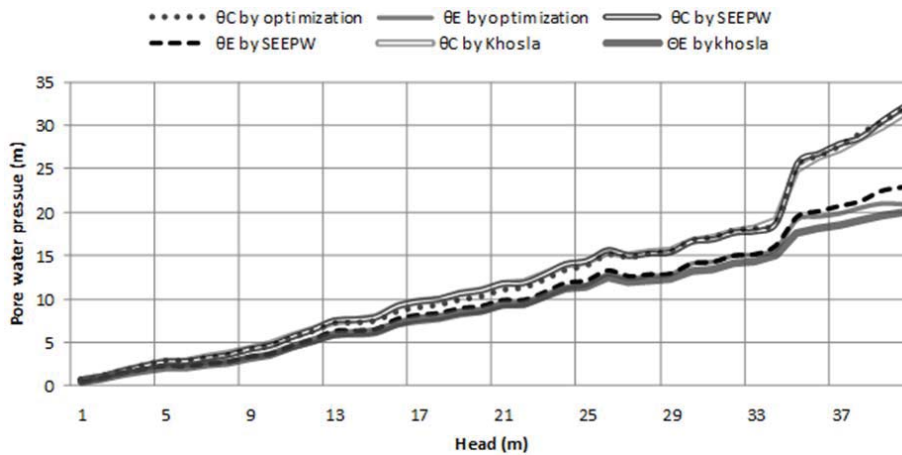

Fig. 11 Comparison of uplift pressure using different methods

IV. CONCLUSION

In this study, two objectives were achieved. An illustrative design study was conducted, and the ANN model was trained with 508 simulated data by using the SEEP/W numerical modeling. The ANN model included three input variables, three output variable and one hidden layer, which

encompassed nine hidden neurons. The transformation function used with the hidden layer was a *Transig* function and the *purelin* with output layer. The ANN model was successfully trained on the simulated data with excellent regression and mean square errors. The ANN was used as a surrogate model to determine the most crucial seepage

characteristics (θC , θE , i_e) as an approximate simulator in the optimization based design model.

The developed surrogate model was incorporated in the optimization model to incorporate cost, safety and accurate seepage analysis in the design of a concrete gravity dam. The simulation-optimization model was solved for different values of head to find optimum design variables for each case, such as (d_1 , d_2 , b , b^* , t_1 , t_2 , etc.). These variables satisfy safe design against piping, overturning, and sliding, simultaneously, and at minimum cost. The results show that the safety factor of exit gradient plays a significant role in stopping criteria of optimization algorithm (GA). However, the simulation-optimization results were evaluated by comparing the solutions with those obtained by using the Khosla's theory and SEEP/W model. These comparisons show convergence between SEEP/W and optimization-simulation results and good agreement with the Khosla theory. Therefore, the proposed methodology of utilizing the linked simulation optimization model incorporating trained ANN based surrogate models is potentially applicable for minimum cost and safe-optimal design of substructure related seepage design of concrete gravity dams.

REFERENCES

- [1] Harr, M.E., *Groundwater and seepage*. 1962: Courier Corporation.
- [2] Shahrbanozadeh, M., G.-A. Barani and S. Shojae, *Simulation of flow through dam foundation by isogeometric method*. Engineering Science and Technology, an International Journal, 2015. **18**(2): p. 185-193.
- [3] Mansuri, B., F. Salmasi and B. Oghati, *Effect of Location and Angle of Cutoff Wall on Uplift Pressure in Diversion Dam*. Geotechnical and Geological Engineering, 2014. **32**(5): p. 1165-1173.
- [4] Lefebvre, G., C. Lupien, J.J. Pare and J.-P. Tournier, *Effectiveness of seepage control elements for embankments on semipervious foundations*. Canadian Geotechnical Journal, 1981. **18**(4): p. 572-576.
- [5] Alsenousi, K.F. and H.G. Mohamed, *Effects of inclined cutoffs and soil foundation characteristics on seepage beneath hydraulic structures*. Twelfth International Water Technology Conference, IWTC12 2008, Alexandria, Egypt 1597, 2008.
- [6] Azizi, S., F. Salmasi, A. Abbaspour and H. Arvanaghi, *Weep Hole and Cut-off Effect in Decreasing of Uplift Pressure*. Journal of Civil Engineering and Urbanism, 2011.
- [7] El-Jumaily, D.K.K. and H.M.J. AL-Bakry *Seepage Analysis Through and under Hydraulic Structures Applying Finite Volume Method*. Eng. & Tech. Journal, Vol. 31, Part (A), No.9, 2013, 2013.
- [8] Moharrami, A., G. Moradi, M.H. Bonab, J. Katebi and G. Moharrami, *Performance of Cutoff Walls Under Hydraulic Structures Against Uplift Pressure and Piping Phenomenon*. Geotechnical and Geological Engineering, 2014. **33**(1): p. 95-103.
- [9] Krahn, J., *Seepage modeling with SEEP/W: An engineering methodology*. GEO-SLOPE International Ltd. Calgary, Alberta, Canada, 2004.
- [10] Joorabchi, A., H. Zhang and M. Blumenstein, *Application of artificial neural networks to groundwater dynamics in coastal aquifers*. Journal of Coastal Research, 2009: p. 966-970.
- [11] Nourani, V., E. Sharghi and M.H. Aminfar, *Integrated ANN model for earthfill dams seepage analysis: Sattarkhan Dam in Iran*. Artificial Intelligence Research, 2012. **1**(2): p. p22.
- [12] Santillán, D., J. Fraile-Ardanuy and M. Toledo. *Dam seepage analysis based on artificial neural networks: The hysteresis phenomenon*. in *Neural Networks (IJCNN), The 2013 International Joint Conference on*. 2013. IEEE.
- [13] Al-Suhaili, R.H. and R.A. Karim, *<optimal dimensions of small hydraulic structure cutoffs using coupled genetic algorithm and ANN model.pdf>*. 2014.
- [14] Mohsin, A.Z., D.H.A. Omran and A.-H.K. Al-Shukur, *Dynamic Response of Concrete Gravity Dam on Random Soil*. International Journal of Civil Engineering and Technology, 2015. **6**(11).
- [15] Yazd, H.G.H., S.J. Arabshahi, M. Tavousi and A. Alvani, *Optimal Designing of Concrete Gravity Dam using Particle Swarm Optimization Algorithm (PSO)*. Indian Journal of Science and Technology, 2015. **8**(12): p. 1.
- [16] Al-Delewy, A.A., D.A.-H.K. Shukur and W.H. AL-Musawi, *Optimum Design of Control Devices for Safe Seepage under hydraulic structures*. Journal of Engineering and Development, Vol. 10, No.1, March (2006) ISSN 1813-7822, 2006.
- [17] Singh, R.M., *Optimal hydraulic structures profiles under uncertain seepage head*. 2011.
- [18] Singh, R.M. and S. Duggal, *Optimal design of hydraulic structures with hybrid differential evolution multiple particle swarm optimization*. Canadian Journal of Civil Engineering, 2015. **42**(5): p. 303-310.
- [19] Seyedpoor, S., J. Salajegheh, E. Salajegheh and S. Gholizadeh, *Optimum shape design of arch dams for earthquake loading using a fuzzy inference system and wavelet neural networks*. Engineering optimization, 2009. **41**(5): p. 473-493.
- [20] Hamidian, D. and S. Seyedpoor, *Shape optimal design of arch dams using an adaptive neuro-fuzzy inference system and improved particle swarm optimization*. Applied Mathematical Modelling, 2010. **34**(6): p. 1574-1585.
- [21] Singh, R.M., *Design of Barrages with Genetic Algorithm Based Embedded Simulation Optimization Approach*. Water Resources Management, 2010. **25**(2): p. 409-429.
- [22] Singh, R.M., *Genetic algorithm based optimal design of hydraulic structures with uncertainty characterization, in Swarm, Evolutionary, and Memetic Computing*. 2011, Springer. p. 742-749.
- [23] Krahn, J., *Seepage modeling with SEEP/W: An engineering methodology*. GEO-SLOPE International Ltd. Calgary, Alberta, Canada, 2012.
- [24] Lj, T., *Dams and appurtenant hydraulic structures*. AA BALKEMA Pubi., Taylor & Francis Group pic, 2014: p. 195-196.
- [25] Novak, P., A. Moffat, C. Nalluri and R. Narayanan, *Hydraulic structures*. 2007: CRC Press.
- [26] Lin, C.D. and B. Tang, *Latin hypercubes and space-filling designs*. 2015, Book chapter of Handbook of Design and Analysis of Experiments, Bingham, D., Dean, A., Morris, M., and Stufken, J. ed. CRC Press.
- [27] Jain, A. and A. Kumar, *An evaluation of artificial neural network technique for the determination of infiltration model parameters*. Applied Soft Computing, 2006. **6**(3): p. 272-282.
- [28] Sivanandam, S. and S. Deepa, *Introduction to neural networks using Matlab 6.0*. 2006: Tata McGraw-Hill Education.
- [29] U.S. Army Corps of Engineers, *Engineering and Design Flotation Stability Criteria for Concrete Hydraulic Structures*. 1987.
- [30] Khosla, A., N.K. Bose and E.M. Taylor, *Design of weirs on permeable foundations*. 1936.
- [31] Terzaghi, K., R.B. Peck and G. Mesri, *Soil mechanics in engineering practice*. 1996: John Wiley & Sons.
- [32] US Army Corps Engineers, *Gravity Dam Design*. Engineer, 1995. 20020626: p. 116.
- [33] Peshko, O., *Global Optimization Genetic Algorithms*. 2007.