

Application of the Neural Network to the Synthesis of Vertical Dipole Antenna over Imperfect Ground

Kais Hafsaoui

Abstract—In this paper, we propose to study the synthesis of the vertical dipole antenna over imperfect ground. The synthesis implementation's method for this type of antenna permits to approach the appropriated radiance's diagram. The used approach is based on neural network. Our main contribution in this paper is the extension of a synthesis model of this vertical dipole antenna over imperfect ground.

Keywords—Vertical dipole antenna, imperfect ground, neural network.

I. INTRODUCTION

IN the domain of smart antenna, several methods of synthesis exist such as stochastic and determinist method [1]. Considering the diversity of aims searched for by users, we don't find a general method of synthesis which is applicable synthesis to all cases, but rather an important number of methods to every type of problem. This diversity of solutions can be exploited to constitute a useful data base for a general approach of synthesis of a vertical dipole antenna.

In this paper, we are interest to present the neural networks method that will be applied to the synthesis of vertical dipole antenna. A big flexibility between features of the antennas: amplitude of feeding, ondulation domain, and secondary lobe level and physic parameters ... is introduced. Since, there is no restriction for the parameters' number of the system in entrance and exit.

II. VERTICAL DIPLOE ANTENNA OVER IMPERFECT GROUND

Consider a vertical linear antenna at a height h over ground as shown below [2]. When the observation point is far from the antenna, the direct and reflected rays r_1 and r_2 will be almost parallel to each other, forming an angle θ with the vertical. The incidence angle α of the previous example is then $\alpha = \theta$, so that the TM reflection coefficient is:

$$\rho_{TM} = \frac{\sqrt{n^2 - \sin^2 \theta} - n^2 \cos \theta}{\sqrt{n^2 - \sin^2 \theta} + n^2 \cos \theta} \quad (1)$$

where

Kais Hafsaoui is with Department of Physics, Faculty of Sciences of Gafsa 2100, Sidi Ahmed Sarouk-Gasfa, Tunisia (e-mail: Tkais.hafsaoui@gmail.com).

$$n^2 = \epsilon_r - j \frac{\eta_0}{2\pi} \nabla \lambda \quad (2)$$

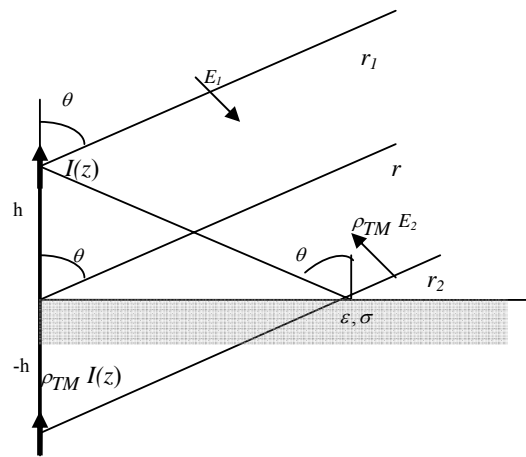

The relative permittivity $\epsilon_r = \epsilon / \epsilon_0$ and conductivity σ (in units of S/m) are given below for some typical grounds and typical frequencies:

The electric fields E_1 and E_2 along the direct and reflected rays will point in the direction of their respective polar unit vector $\hat{\theta}$, [2] as seen in the above figure. According to the sign conventions, the reflected field $\rho_{TM} E_2$ will be pointing in the $-\hat{\theta}$ direction, opposing E_1 . The net field at the observation point will be:

$$E = E_1 - \rho_{TM} E_2 = \hat{\theta} k \eta \frac{e^{jk r_1}}{4\pi r_1} F_z(\theta) \sin \theta - \hat{\theta} k \eta \frac{e^{-jk r_2}}{4\pi r_2} \rho_{TM} F_z(\theta) \sin \theta \quad (3)$$

where $\mathbf{F}(\theta) = \hat{z} F_z(\theta)$ is the assumed radiation vector of the linear antenna. Thus, the reflected ray appears to have originated from an image current $-\rho_{TM} I(z)$. Using the approximations $r_1 = r - h \cos \theta$ and $r_2 = r + h \cos \theta$ in the propagation phase factors $e^{-jk r_1}$ and $e^{-jk r_2}$, we obtain for the net electric field at the observation point (r, θ) :

$$E = \hat{\theta}jk\eta \frac{e^{-jkr}}{4\pi r} F_z(\theta) \sin \theta \left[e^{jkh \cos \theta} - \rho_{TM} e^{-jkh \cos \theta} \right] \quad (4)$$

It follows that the (unnormalized) gain will be:

$$g(\theta) = \left| F_z(\theta) \sin \theta \right|^2 \left| 1 - \rho_{TM}(\theta) \right|^2 e^{-2jkh \cos \theta} \quad (5)$$

The results of the previous example are obtained if we set $\rho = -\rho_{TM}$. For a Hertzian dipole, we may replace $F_z(\theta)$ by unity. For a half-wave dipole [2], we have:

$$g(\theta) = \left| \frac{\cos(0.5\pi \cos \theta)}{\sin \theta} \right|^2 \left| 1 - \rho_{TM}(\theta) \right|^2 e^{-2jkh \cos \theta} \quad (6)$$

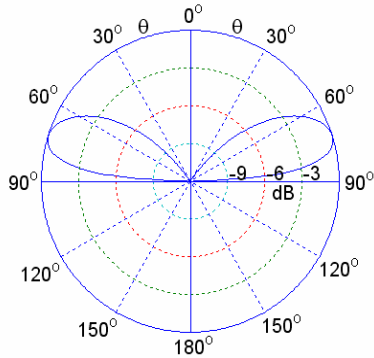

Fig. 1 Vertical dipole over imperfect ground ($h = \lambda/4, f = 1$ MHz)

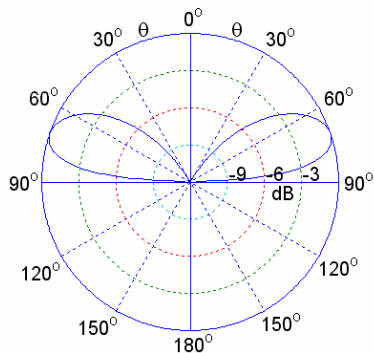

Fig. 2 Vertical dipole over imperfect ground ($h = \lambda/4, f = 500$ MHz)

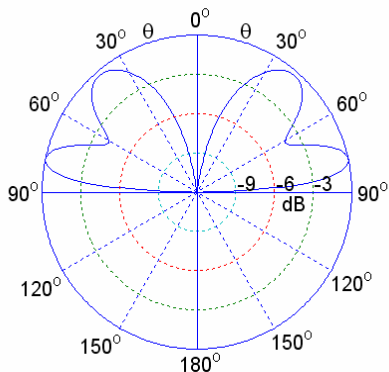

Fig. 3 Vertical dipole over imperfect ground ($h = \lambda/2, f = 1$ MHz)

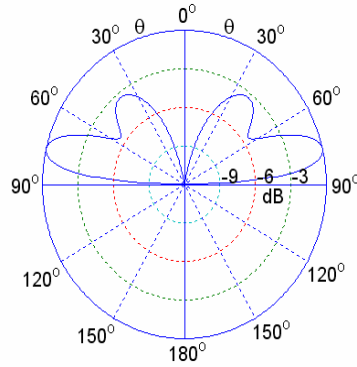

Fig. 4 Vertical dipole over imperfect ground ($h = \lambda/2, f = 600$ MHz)

Figs. 1, 2, 3 and 4 shows the resulting gains for a half-wave dipole at heights $h = \lambda/4$ and $h = \lambda/2$ and at frequencies $f = 1$ MHz and $f = 500$ MHz and $\epsilon_r = 15, \sigma = 10^{-3}, \epsilon_0 = 8.854 \cdot 10^{-12}$. The dashed curves represent the gain of a single dipole, that is, $G(\theta) = \left| \cos(0.5\pi \cos \theta) / \sin \theta \right|^2$. Thus, the presence of the ground significantly alters the angular gain of the dipole. For the case $h = \lambda/2$, we observe the presence of grating lobes, arising because the effective separation between the dipole and its image is $2h > \lambda/2$.

III. FORMULATION

The artificial neuron networks ANN are the inspired mathematical models of the structure and the behaviour of biologic neural. They are composed of interconnected units that we call formal or artificial neural capable to achieve some particular functions [3, 4]. The ANN permits to approach nonlinear and high complex relations of complexity degrees. Cells of entrances are destined to collect information that is transformed by the hidden cells until cells of exit. This system possesses one or several hidden layers (Fig. 1). Generally we use in this type of networks a sigmoid activation function.

$$g(x) = \frac{1}{1 + \exp(-x)} \quad (7)$$

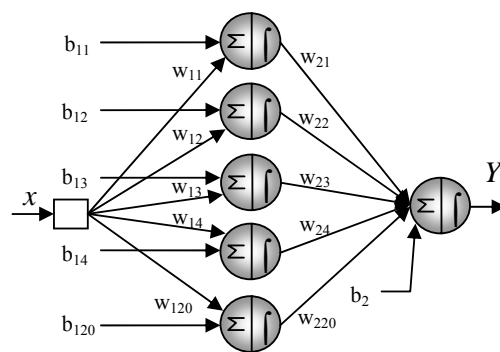

Fig. 5 Network architecture

The training in this type of network, consist in a practice. We present entrance for the network and ask him to modify their attitudes to recover the corresponding exit [5,6].

The algorithm consists at the first time to propagate entrances until we get one calculated exit by the network. The second stage compares the calculated exit to the known real exit. We modify the synaptic weights then to have in the next iteration a minimum mistake committed between the calculated exit and known exit. We retro-propagate the mistake committed until the layer of entrance then while modifying the weight.

The expression of the new values of synaptic weight joining neurons is given by the following relation [4]

$$w_{ij}(k+1) = w_{ij}(k) + \lambda D_i P_j \tag{8}$$

with

λ : Training step

P_j : the entrance of the j neuron.

W_{ij} : Weight associated to the connection of the i neuron toward the j neuron.

D_i : Drifted of mistake of the i neuron.

IV. RESULTS

The neural network is constructed by an iterative process on the elements of database content in the training file.

Every iteration permits to minimize mean square error between exits of the RNA and given elements

We will retail here the procedure of implementation of the neural network. We take the case of survey a network presenting the radiance diagram of a straight network of N =20 beaming elements.

This network is called perceptron organized of three layers: the first and the third are respectively the entrance layer and the exit layer organized by a lonely neuron, the second is the hidden layer. This procedure must be preceded by a training stage to fix the different parameters of the network. Stages of advanced conception are general and can applied on any type of perceptron network whatever is the number of entrances and the number of hidden layers.

A. Training Phase

After several tests, a multilayer network is kept with the following topology:

- A neuron in the layer of entrance representing the level of lobes wanted.
- 20 neurons in the hidden layer
- A neuron in the exit layer.

Once the architecture of the network has been decided, the phase of training permits to calculate synaptic weights taking to every formal neuron. It uses the algorithm of Quasi-Newton [5, 6]. This algorithm consists in presenting to the network of training examples of training, games of activities of entrance neurons as well as those of activities of exit neurons. We examine the gap between the exit of the network and the exit wished and we modify synaptic weights of connections until the network produces a very near exit from the desired one. The training by MATLAB is supervised [6]. Linear functions

and hyperbolic tangent are affected to the hidden layer and the layer of exit respectively.

The essential aim here is to find the best training that permits to give a good model.

Several tests are necessary. We have to act on parameters influencing on the training. These parameters are:

- Number of neurons in the hidden layer,
- Activation function,
- Training step.

The training phase is illustrated by Fig. 3. It represents the evolution of the mean square error between exits of the RNA and samples given according to the number of epochs, the gotten final error is $1.05133 \cdot 10^{-5}$.

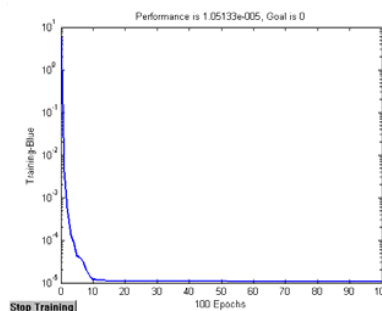

Fig. 6 Training phase

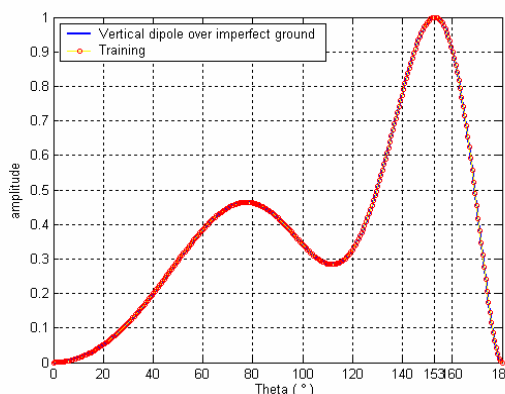

Fig. 7 Vertical dipole over imperfect ground ($h = \lambda/2, f = 600$ MHz)

Figs. 6 and 7 present synthesis results of Vertical dipole over imperfect ground. We present in this part the the training phase with $h = \lambda/2$ and $f = 600$ MHz.

V. CONCLUSION

In this paper, we only developed a technique of synthesis of Vertical dipole over imperfect ground with different frequency and height dipole. We used multilayer neural networks of Feed forward type, in particular, the multilayer MLP, because this type is adapted for our theory.

We are interested to the Vertical dipole over imperfect ground, particularly to their modelling and optimization by neural network.

The neural approach reduced the resolution time at the application phase or generalization. The precision of the model constructed depends on the data base of the training

phase. However, multilayer neural networks present the inconvenience in time resolution due to the training phase and the absence of a general law to define the architecture of the network.

REFERENCES

- [1] S. J. Orfanidis "Electromagnetic Waves & Antennas " –June 21, 2004
- [2] I. J. Bahl, P. Bhartia, " Microstrip antennas", Artech House, USA, 1980.
- [3] Y. Chunyang, G. Deyuan, W. Wenbing, "Non uniform linear antenna array optimization –genetic algorithm approach ", ISAE'97 proceeding, 1997.
- [4] B. Muller, J. Reinhardt, M. T. Streckland, "Neural networks an introduction", Springer-verlang, Berlin Heidelberg, 1995.
- [5] Y. Hammou, M. Zerikat, A. Belaidi, "Application des réseaux de neurones pour l'identification d'un moteur à courant continu en vue de son contrôle", COMAEI'96, Tlemcen, 1996.
- [6] H. Demuth, M. Beale, "Neural network toolbox for use with Matlab ", Users guide, mathworks, 1997.
- [7] F. Sagnard, B. Uguen, G. El Zein " Etude de l'émission et de la réception de signaux pulsionnels par des antennes Ultra large bande : modélisation et expérimentation " IETR-UMR CNRS.