

# A Unified Approach for Naval Telecommunication Architectures

Y. Lacroix, J.-F. Malbranque

**Abstract**—We present a chronological evolution for naval telecommunication networks. We distinguish periods: with or without multiplexers, with switch systems, with federative systems, with medium switching, and with medium switching with wireless networks. This highlights the introduction of new layers and technology in the architecture. These architectures are presented using layer models of transmission, in a unified way, which enables us to integrate pre-existing models. A ship of a naval fleet has internal communications (i.e. applications' networks of the edge) and external communications (i.e. the use of the means of transmission between edges). We propose architectures, deduced from the layer model, which are the point of convergence between the networks on board and the HF, UHF radio, and satellite resources. This modelling allows to consider end-to-end naval communications, and in a more global way, that is from the user on board towards the user on shore, including transmission and networks on the shore side. The new architectures need take care of quality of services for end-to-end communications, the more remote control develops a lot and will do so in the future. Naval telecommunications will be more and more complex and will use more and more advanced technologies, it will thus be necessary to establish clear global communication schemes to grant consistency of the architectures. Our latest model has been implemented in a military naval situation, and serves as the basic architecture for the RIFAN2 network.

**Keywords**—Equilibrium beach profile, eastern tombolo of Giens, potential function, erosion.

## I. INTRODUCTION

THIS article presents a model of the network architectures and telecommunications [1]-[3] in the naval field, civilian [4] or military, and illustrates the causes and the consequences of the development and the techniques used to answer increasingly many needs.

Design for marine telecommunications is little known; however, some models of architecture are proposed, according to specific needs [6], [7]. We propose here a generic model for architectures for the elements of transmissions in the maritime domain in particular military which can transpose to civilian configurations. This modelling approach has served as a framework for the development of the latest RIFAN2 telecommunication network in the French navy. It has the advantage of integrating easily pre-existing models, which, for such an implementation, is necessary, since equipment and configurations range from the most recent to several decades old.

Y. Lacroix is with the SEATECH, Avenue G. Pompidou, 83162 La Valette du Var Cedex, France and MEMOCS, Università Degli Studi Dell'Aquila, Italy (e-mail: yves.lacroix@univ-tln.fr).

J.-F. Malbranque is with the DGA/TN, Le Mourllon, Toulon Armées, France (e-mail: jfinalbranque@hotmail.com).

The paper is organized as follows. We first give an overview diagram of transmission chain for naval communications, and describe briefly its main components. Then, we adopt a layer model for architectures and step by step present a chronological view of their evolution, each step explaining the needs for evolution, the next one providing a solution. The solution, so to say the next generation architecture, may come from the introduction of new technology, and/or, adding a layer or redefining connections and protocols. We conclude by observing that remote control, which gains importance recently, and will continue to, defines the needs for the development of quality of services (QoS) and management of parameters.

## II. OVERVIEW DIAGRAM OF TRANSMISSION CHAIN OF NAVAL COMMUNICATIONS

Following the example of OSI layers [5], naval communication systems in the case of an important fleet can be layer modelled as follows:

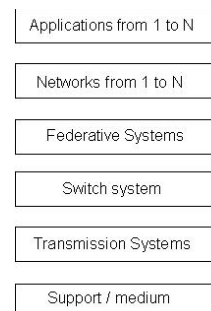

Fig. 1 Model of architecture of naval telecommunication

Each layer of this model has specific equipment and parameters, those last ones can take use the OSI or TCP/IP protocol stacks [8].

We define an end to end link as the route of data from a source entity to a destination entity; the overview diagram of such is thus the following one (every end-to-end link does not contain all the elements of this overview diagram, according to the type of maritime units which are involved):

### A. Supports and Media

Media are of two types: the first one is the ground radio transmission domain, mainly the ranges of frequencies HF, UHF and VHF [9], the second is the satellite transmission one.

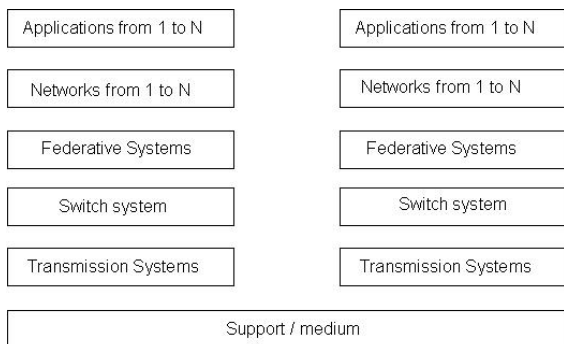

Fig. 2 Model of general architecture for an end to end link

**B. Transmission Systems**

These systems give the access to the support/medium of transmission, they are the radio elements:

- antenna system;
- RF switching / Filter units;
- radios;
- modems;
- management systems for radio elements.

All these elements have different characteristics depending on the manufacturers; we can define a generic overview diagram presenting the links between the equipment:

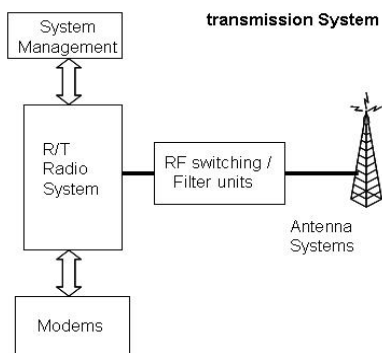

Fig. 3 Model of transmission system

**C. Switch Systems**

They serve generally to adapt the data debits of applications in networks to radio components. The equipment consists of sometimes ATM switches [10] which allow the adaptation of the applications' debits to the radio elements, a management of QoS, and a network meshing between different participants.

**D. Federative Systems**

These systems serve for on board networks, which have a tendency to develop anarchically: they federate various local networks. In general, these are big routers which can route data and manage the parameters for QoS.

**E. Networks**

On board applications are divided according to functional or confidentiality categories. It is therefore necessary to collect the characteristics of these applications to gather them on the same network.

The knowledge of the application networks that is their level of confidentialities is very important to construct a coherent architecture.

Several networks can coexist, according to the complexity of the network architecture on board; the federative equipment then grants the coherence of the communications.

**F. Applications**

In this layer of the model, three aspects which are important are:

- the characteristics of applications (for example of type real time or not);
- the matrices of flows (characteristics of the parameters of applications (debits, real time or not, acceptable latency, etc.)), as the routes of flows (ship-ship or ship-shore).
- the QoS parameters of the various applications in order to program them in the various network equipment.

**III. EVOLUTION OF THE ON-BOARD ARCHITECTURES**

The chronology of the architectures evolutions that we tested can be divided in five periods:

- before multiplexers;
- multiplexers;
- switch system;
- federative system;
- switching of media;
- communications with wireless medium.

These architectures can still be organized today using our telecommunication architecture model. Let us briefly describe these different periods.

**G. The Period before Multiplexers**

In the 80s, the ship-shore communications went through the few satellite resources [11]-[13] with debits ranging from 2400 b/s up to 64 kb/s. It sometimes happened that UHF radio resources were used [9], for short distances, or HF for the longest ones.

There were few on board local networks, few applications, mainly phone communications and small files transfer. The overview diagram below presents the type of communications which was on board. This architecture is minimal, only a layer "application" and a layer "transmission systems", the later establishing the node of this architecture. Here is an example of marine architecture without multiplexer: In this architecture, we have a small number of application stations, directly connected to the satellite stations, moreover the bandwidth was not dynamically shared.

The need to enable a greater number of applications to use the same media led to the introduction of multiplexers.

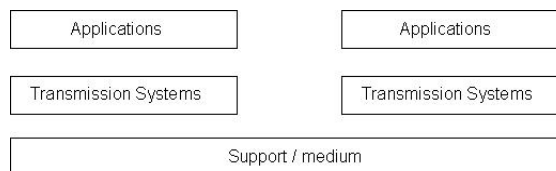

Fig. 4 Model of architecture before multiplexer

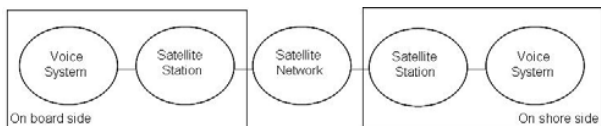

Fig. 5 Example of marine architecture without multiplexer

H. The Period of Multiplexers

At the very beginning, multiplexers were static, which means the bandwidth was fixed for each application. If an application did not use its part of bandwidth, it was lost for the others. The use of the dynamic multiplexers increased the performance. The model of architecture is the following one: This model introduces the layer “systems of switching”, assumed here by multiplexers. Let us give an example of marine architecture with multiplexer: This architecture evolved naturally, guided by the need to optimize the use of the bandwidth: the dynamic management of the support/medium of communication becomes a priority; this is where switches emerged from. As a constraint, the switch needed to manage the flows so as to share the bandwidth according to the specific qualities of services that emerged.

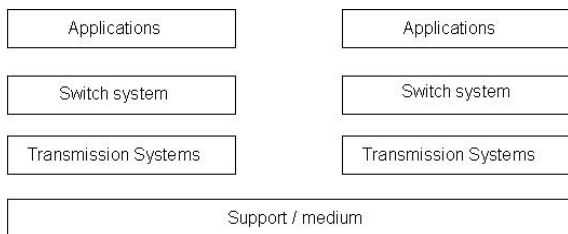

Fig. 6 Model of architecture with multiplexers

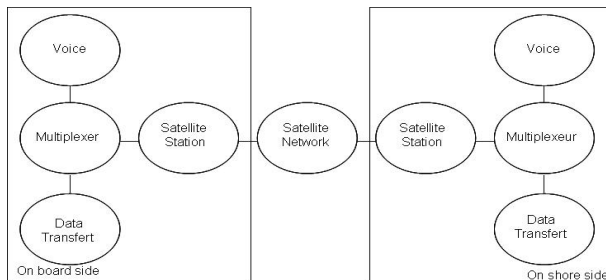

Fig. 7 Example of marine architecture with multiplexer

I. The Period of Switch Systems

The use of switches [14], [15] allowed IP applications to benefit from the optimization of the bandwidth use and the management of flows in particular by introducing QoS. The model of architecture is the following: In this model, we introduce the layer “switch system” “strictly” speaking, whereas the “network” layer collects all the networks connected to the switch. Let us give an example of marine architecture with multiplexer:

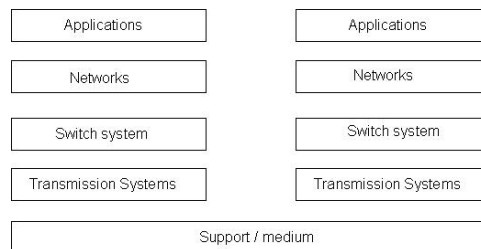

Fig. 8 Model of architecture with switch

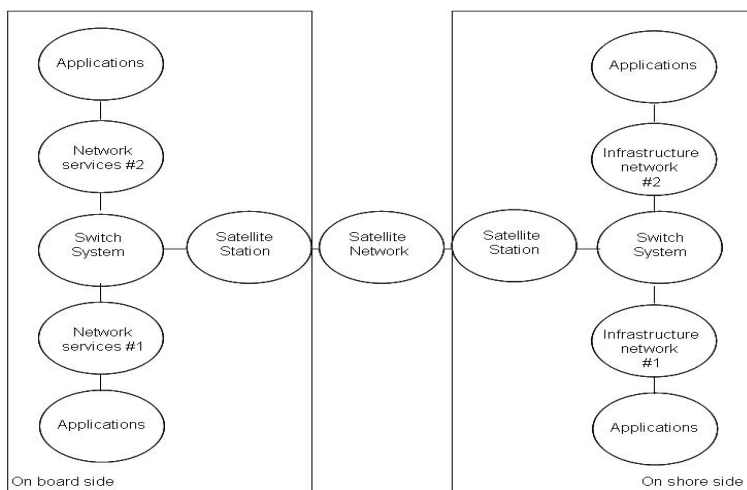

Fig. 9 Example of marine architecture with switch system

The evolution of this type of architecture comes from the fact that more and more non-IP data mode applications migrate to IP mode applications [16]-[20], [28], [29], [33]. Therefore, there is a need to federate and to control all the IP applications and to manage IP flows.

J. The Period of Federative Systems

This period corresponds to the implementation, on board, of architectures with federative equipment [21], [22], able to differentiate confidentiality levels of applications. The model of the architecture is the following:

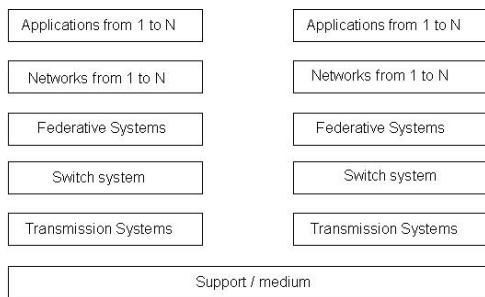

Fig. 10 Model of architecture with federative system

In this model, the layer “federative systems” is used for the differentiation of networks on board by level of confidentiality or by functional level. Let us give an example of marine architecture with federative system:

As regards, the architectures on the shore side, they are almost identical to the ship ones, except that they have some more security levels.

The needs of evolution of this type of architecture are four types:

- management of flows by considering the QoS,
- optimization of the connections,
- enable the definition of new levels of confidentiality,
- consideration of radio links [23].

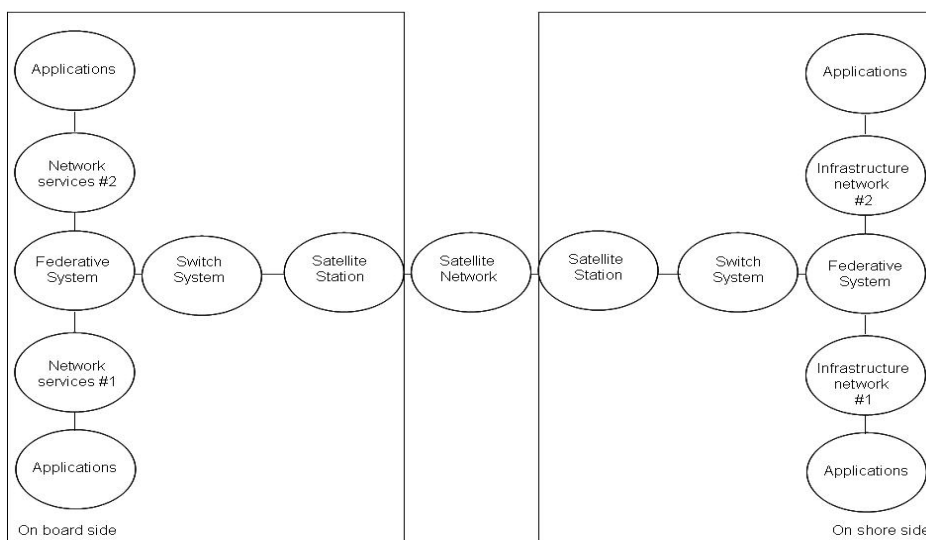

Fig. 11 Example of architecture Marine with federative system

**K. The Period of Medium Switching**

This period corresponds to the implementation of radio links on ranges such as HF or UHF. These links did not evolve much during the previous periods.

The architecture below shows the consideration of the radio HF UHF [24] at first; switching mechanisms of medium are implemented in the federative routers. In this model, the layer “Federative Systems ” allows satellite communications through the layers " Switch System " and "Transmission Systems"; it also allows radio communications by the layer "Transmission systems".

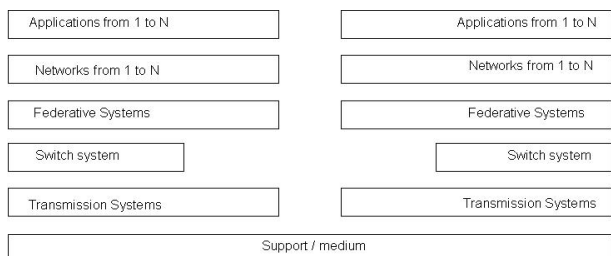

Fig. 12 Model of architecture with medium switching

The choice of communication paths can be made through routing protocols like RIP [30] or OSPF [31] and possibly BGP [32] but essentially by marking flows with the mechanisms of QoS, process more generally called “Load Balancing”. The needs of evolution of this architecture are the consideration of the broadband HF radio HF and satellite UHF transmissions, the integration of wireless networks of any type, and at the networks' level, QoS in end-to-end links must be implemented to ensure an homogeneous network.

**L. The Period of Medium Switching with Wireless Networks**

The architectures have to include wireless networks [25]; these networks will be installed inside an existing naval architecture.

All the wireless networks will be included in the model through the services networks; we embed one model of architecture of telecommunication in the other one. This example shows the most complete possible architecture which can be on ship board, but also in a management center on the shore side.

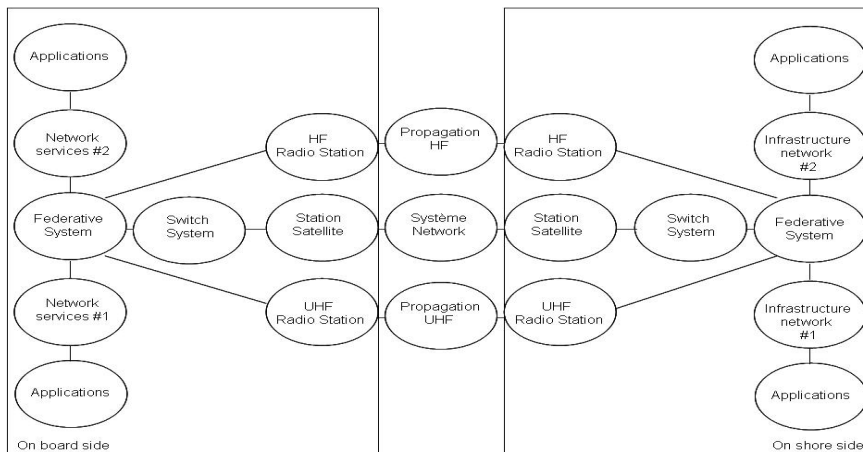

Fig. 13 Example of media switching marine architecture

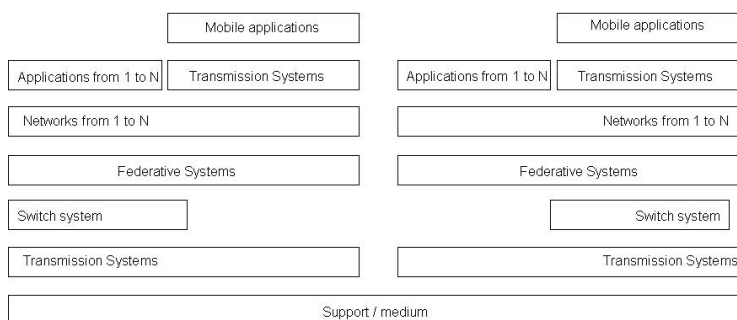

Fig. 14 Model of medium switching architecture with wireless network

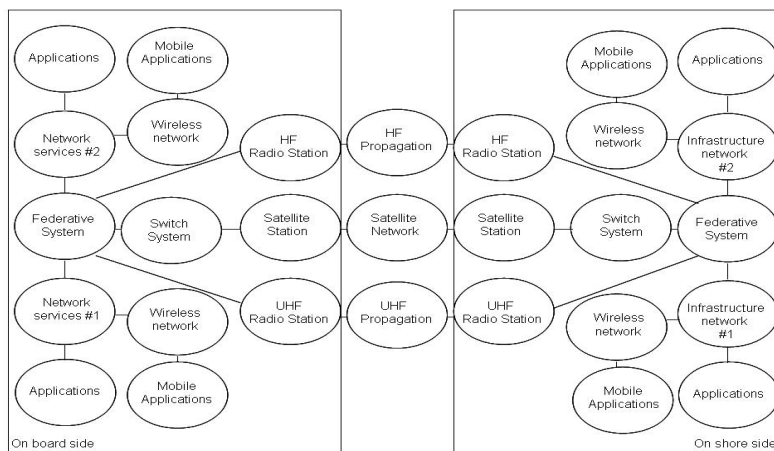

Fig. 15 Example of media switching marine architecture with wireless networks

*M. Conclusion*

1. Towards a Shore's Side Integrated Management

Satellite communications now serve for data transmission as well as for remote onboard equipment control. The tendency now goes towards remote control of on board configurations.

Spatial communications are more and more used for big data files transfer, whereas small files transfer between ships are made by specific protocols using the radio in range UHF or HF.

Remote management needs a lot of parameter communication; we can establish a model of these communications as follows:

2. Towards a Generalized QoS

Starting from the naval architectures of type "medium switching", we speak about QoS [26]: indeed, we set up QoS mechanisms in order to dispatch the flows on board towards a given medium on board.

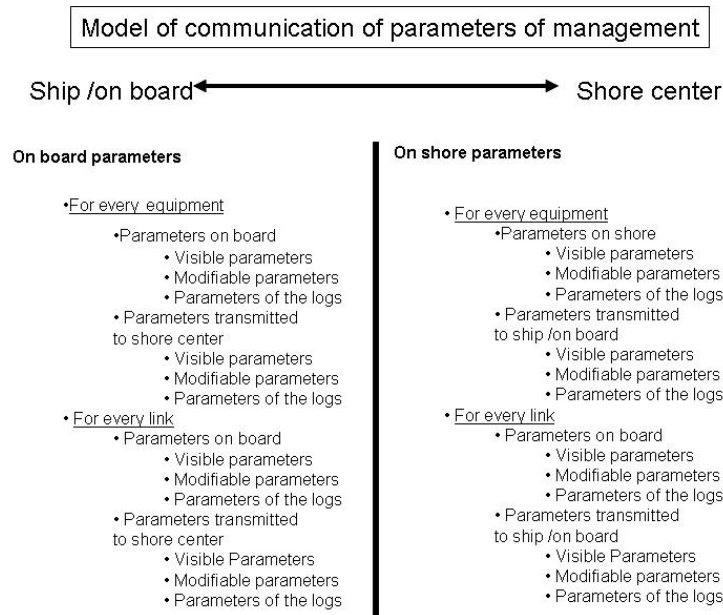

Fig. 16 Management of parameters' communication

The main QoS mechanism is that of marking flows according to rules (policy) of QoS which are appropriate for the board side; however, when these flows arrive at the shore center, they may cross networks of infrastructures having different QoS policies [27]. Coherent QoS policies between networks on board and the networks of infrastructure on shore centers are thus needed. Therefore, naval telecommunication architectures are in complete mutation [28], [29].

We will comment on the QoS in a forthcoming publication [34].

Our latest model has been implemented through the RIFAN2 network which is the latest system for naval communications for the French navy.

#### REFERENCES

- [1] Krzysztof Iniewski, Carl Mccrosky, Daniel Minoli. Network Infrastructure and Architecture. Designing High-Availability Networks. New Jersey, 2008, Wiley & Sons, 564 Pages.
- [2] International Engineering Consortium. The basics of Telecommunications. Chicago, Illinois, 2002, 420 Pages. [www.iec.org](http://www.iec.org).
- [3] Roger L. Freeman. Fundamentals of Telecommunications. Second Edition. IEEE Presse. Hoboken, New Jersey, 2005, Wiley & Sons, Inc, 705 Pages.
- [4] João Ascenso ISEL, Lisbon, Portugal Luminita Vasiliu University of Westminster, London, UK Carlos Belo Lisbon, Portugal and Mónica Saramago INSTICC, Setúbal, Portugal. E-business and Telecommunications Networks. Dordrecht, The Netherlands, Springer, 289 pages.
- [5] ISO/IEC 7498-1 Information Technology, Open Systems Interconnection Basic Reference Model: The Basic Model. Modèle de référence de base pour l'interconnexion de Systèmes ouverts (OSI). 1994(E), 68 pages.
- [6] Richard S. Whitt A Horizontal Leap Forward: Formulating a New Communications Public Policy Framework Based on the Network Layers Model MCI Inc, 2004, 86 Pages.
- [7] Douglas C. Sicker and Joshua L. Mindel. Refinements Of A Layered Model For Telecommunications Policytelecommunications & High Technology Law (Vol. 1), 2010, 26 Pages.
- [8] Pate Loshin. TCP/IP Clearly Explained. Fourth edition 2003, Morgan Kaufmann publishers, Elsevier science, 737 Pages.
- [9] Harris Corporation. Radio communications in the digital age. VHF/UHF Technology. Volume Two. Harris Corporation, RF Communications Division. June 2000, 56 Pages.
- [10] Nortel Magellan Training. ATM on Passport, Student notes. Release P4.1, version 5, 1997, North Telecom.
- [11] Dennis Roddy. Satellite Communications Third Edition New York, 2001, McGraw-Hill Telecom, 586 Pages.
- [12] Regis J. (Bud) Bates. Broadband Telecommunications Handbook, Second Edition. 2002, McGraw Hill, 590 Pages.
- [13] Tarmo Anttalainen. Introduction to Telecommunications Network Engineering. Second Edition. Norwood, 2003, Artech House Inc, 399 Pages.
- [14] Nortel Magellan Training. Passport Network Engineering, student notes. Release P3.4, version 2. 1997, North Telecom.
- [15] EADS TELECOM. EADS TELECOM presents its turn-key secure communication solutions, based on commercial technologies, for Defence networks. ATHREIS: EADS TELECOM. Paris, 2002, 3 pages. [http://www.eads.com/eads/int/en/news/press.en\\_20020617\\_eurosatory\\_e.html](http://www.eads.com/eads/int/en/news/press.en_20020617_eurosatory_e.html).
- [16] Alberto Leon-Garcia & Indra Widjaja. Communication Networks. Fundamental Concepts and Key Architectures. 2001, McGraw Hill, 889 Pages.
- [17] E. Bryan Carne. A Professional's Guide to Data Communication in a TCP/IP World. Norwood, 2004 Artech House Inc, 276 Pages.
- [18] Walter Goralski. The Illustrated Network How TCP/IP Works in a Modern Network 2009, Elsevier, 829 Pages
- [19] Gilbert Held. Ethernet networks. Fourth Edition. Design, Implementation, Operation, Management. 2003, John Wiley & Sons, 599 Pages.
- [20] Martin P. Clark. Data Networks, IP and the Internet. Protocols, Design and Operation. Telecommunications Consultant. Germany, 2003, Wiley & Sons, 867 Pages.
- [21] EADS TELECOM. EADS Defence & Security, DCNS and Rohde & Schwarz consortium receives go-ahead from DGA to implement RIFAN armaments programme, stage 2, for French Navy. 2009, 2 Pages. [http://www.eads.com/service/html2pdf/eads/int/en/news/press.20100519\\_eads\\_defence\\_rifan.pdf](http://www.eads.com/service/html2pdf/eads/int/en/news/press.20100519_eads_defence_rifan.pdf).
- [22] Thales Group. Intelligent Maritime Solution. 2010, Elancourt, 24 Pages. [http://www2.thalesgroup.com/blogs/euronaval/files/2010/10/naval\\_activites\\_fr.pdf](http://www2.thalesgroup.com/blogs/euronaval/files/2010/10/naval_activites_fr.pdf).
- [23] John S. Seybold, Ph.D. Introduction to RF Propagation. New Jersey, 2005, Wiley & Sons, 349 Pages.
- [24] H. Sizun. Radio Wave Propagation for Telecommunication Applications.

- Paris, 2003, Springer, 423 Pages.
- [25] Alan Bensky. *Wireless Positioning Technologies and Applications*. 2008, Artech House Inc, 310 Pages.
- [26] Gerald Ash, Bruce Davie, John Evans, Adrian Farrel, Clarence Filsfils, Pete Loshin, Deepankar Medhi, Monique Morrow, Rogelio Martinez Perea, Larry L. Peterson, Karthik Ramasamy, John Strassner, Kateel Vijayananda, Zheng Wang, *Network Quality of Service*. 2009, Morgan Kaufmann Publishers Elsevier, 351 Pages.
- [27] IEEE Communications Magazine, January 2002. BUILDING A QOS-ENABLED IP NETWORK A Practical Architecture for Implementing End-to-End QoS in an IP Network.
- [28] Vijay K. Gurbani, Xian-He Sun. *Architecting the Telecommunication Evolution. Toward Converged Network Services*, Boca Raton (FL), 2007, Auerbach Publications, 290 Pages.
- [29] OECD. *Infrastructure to 2030. Telecom, Land Transport, Water and Electricity. Chapitre 2 Telecoms Infrastructure to 2030*. Paris, 2006, Organisation For Economic Co-Operation And Development OECD.
- [30] RFC numbers (Request For Comments) for RIP (Routing Information Protocol): 1058, 2453, 2080, 1721, 1722, 1388.
- [31] RFC numbers (Request For Comments) for OSPF (Open Shortest Path First): 1131, 1245, 1246, 1247, 1370, 1583, 1584, 1585, 1586, 1587, 2178, 2328, 2329, 2370.
- [32] RFC numbers (Request For Comments) for BGP (Border Gateway Protocol): 1092, 1105, 1163, 1265, 1266, 1267, 1364, 1392, 1403, 1565, 1654, 1655, 1665, 1771, 1772, 1745, 1774, 2283.
- [33] Request for Comments web: <http://www.rfc-editor.org>, <http://www.cis.ohio-state.edu/services/rfc>.
- [34] Y. Lacroix & J.-F. Malbranque, *Quality of services over radio link for naval communications: a Diffserv model approach*, Preprint, 2013, 14 pages.