

A Robust Software for Advanced Analysis of Space Steel Frames

Viet-Hung Truong, Seung-Eock Kim

Abstract—This paper presents a robust software package for practical advanced analysis of space steel framed structures. The pre- and post-processors of the presented software package are coded in the C++ programming language while the solver is written by using the FORTRAN programming language. A user-friendly graphical interface of the presented software is developed to facilitate the modeling process and result interpretation of the problem. The solver employs the stability functions for capturing the second-order effects to minimize modeling and computational time. Both the plastic-hinge and fiber-hinge beam-column elements are available in the presented software. The generalized displacement control method is adopted to solve the nonlinear equilibrium equations.

Keywords—Advanced analysis, beam-column, fiber-hinge, plastic hinge, steel frame.

I. INTRODUCTION

THE member-based design method in analysis of steel frames seems tedious since the interaction of strength and stability between frame members and system is not directly considered. Therefore, over the last three decades, the development of practical advanced analysis (PAA) methods have been devoted. In PAAs, not only the structural load-carrying capacity is directly estimated, but also the real nonlinear behaviors of structure are captured (see [1]-[3], among others). PAAs in the literature can be classified into two categories: Plastic zone [4] and plastic hinge methods [5]. Although the plastic zone methods are known as the “exact” methods, they have not been widely used in practical design because their excessive computational time. In the plastic hinge method or beam-column approach, only one or two elements per structural member are needed to estimate nonlinear inelastic behaviors of structure, so the computational time of this method is considerably decreased.

By using the beam-column approach, several computer programs for nonlinear inelastic analysis of steel frames have been developed such as OpenSees [4], DRAIN-3DX [5], and FRAME3D [6]. In OpenSees, the beam-column elements with both concentrated and distributed plasticity are included, while $P-\Delta$ effect is captured by using corotation technique. In DRAIN-3DX, $P-\Delta$ effect is considered by adding the geometric stiffness to the tangent stiffness matrix, while the material

nonlinearity is estimated by using the fiber-hinge method. In FRAME3D, $P-\Delta$ effect is automatically captured by using a geometric updating feature to accommodate large translations and rotations of the beam elements. However, the $P-\delta$ effect is not considered in the aforementioned programs. Therefore, the numerical results by using these programs are unreliable.

In this work, an efficient software for PAA of space steel frames is proposed. For performing nonlinear inelastic analysis of structure, the beam-column approach is used, in which $P-\delta$ and $P-\Delta$ effects, the initial geometric imperfection, and the gradual stiffness degradation are considered. In the proposed software, both plastic-hinge and fiber-hinge beam-column elements are available, while the nonlinear equations are solved by using the generalized displacement control method (GDC). A user-friendly graphical interface is developed to facilitate the modeling process and the presentation of analysis results. A two-story space frame is used to investigate the accuracy and effectiveness of the presented software.

II. PRACTICAL ADVANCED ANALYSIS

A. Library of Elements

For steel frame analysis, the presented software concludes two basis nonlinear beam elements such as the plastic-hinge and fiber-hinge beam-column elements.

In the plastic-hinge beam-column element, the $P-\delta$ and $P-\Delta$ effects are captured by using stability functions proposed by Chen and Lui [7], while the CRC tangent modulus concept proposed by Chen and Lui [8] is used to account for residual stresses and initial geometric imperfection. The model of gradual stiffness degradation is also employed using the yield surface proposed by Orbison et al. [9] for capturing the partial plastification effects of plastic hinges in the case of small axial force and large bending moments. Generally, one or two elements are enough for modelling a frame member, so computational time is significantly reduced. However, this element is still limited to the lumped-plasticity model. The additional information of this element can be found in [10].

In the fiber-hinge beam-column element, the cross-sectional area of frame member is divided into many fiber elements as shown in Fig. 1. Therefore, the spread of plasticity throughout the member length can be captured by using this element. The analysis of a fiber is similar to that of a plastic-hinge beam-column element. Additional information of this element can be found in [11].

Viet-Hung Truong is a PhD student of the Department of Civil and Environmental Engineering, Sejong University, 98 Kunja Dong Kwangjin Ku, Seoul 143-747, Republic of Korea (phone: +82-2-3408-3607, fax: +82-2-3408-3607; e-mail: readysgo@naver.com).

Seung-Eock Kim is a professor of the Department of Civil and Environmental Engineering, Sejong University, 98 Kunja Dong Kwangjin Ku, Seoul 143-747, Republic of Korea (phone: +82-2-3408-3291, fax: +82-2-3408-4332; e-mail: sekim@sejong.ac.kr).

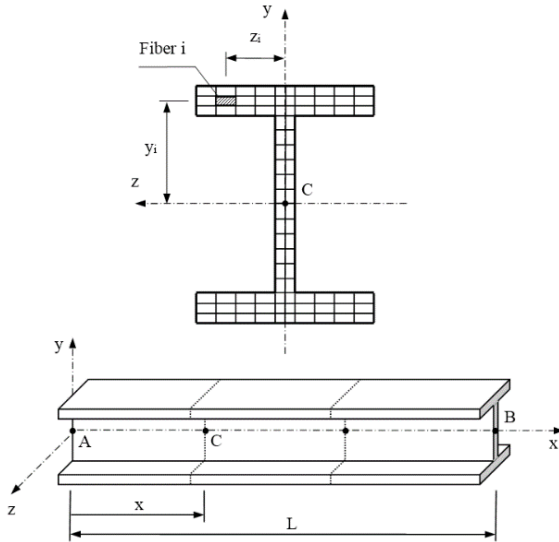

Fig. 1 Discretization of beam-column element

B. Nonlinear Solution Procedure

Among several numerical methods, GDC method proposed by Yang and Shieh [12] is used in this work since it is robust and effective for solving the nonlinear problems with multiple critical points. The detail of the nonlinear solution procedure using GDC can be found in [10].

III. INTERACTIVE GRAPHIC SOFTWARE

The interface of the proposed software is designed very friendly with three main parts of pre-processor, solver, and post-processor as shown in Fig. 2. The solver of the proposed software is written in FORTRAN, while the pre- and post-processors are developed using Visual C++.

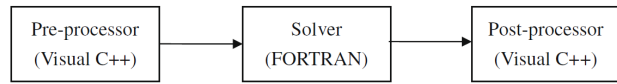

Fig. 2 Flow chart of the presented software

A. Main Graphic User Interface

The main graphic user interface of the proposed software is presented in Fig. 3. Four basic menus are provided such as main menu, tree menu, icon menu, and result menu. The structure can be shown in plane or 3D perspective views, while two view windows can be used at same time.

B. Input Database

The presented software provides the users two options for inputting the structural information. In the first option as shown in Fig. 4, the data can be read from a formatted input file. In the second option, the model of structure can be directly made in the pre-processor as presented in Fig. 5.

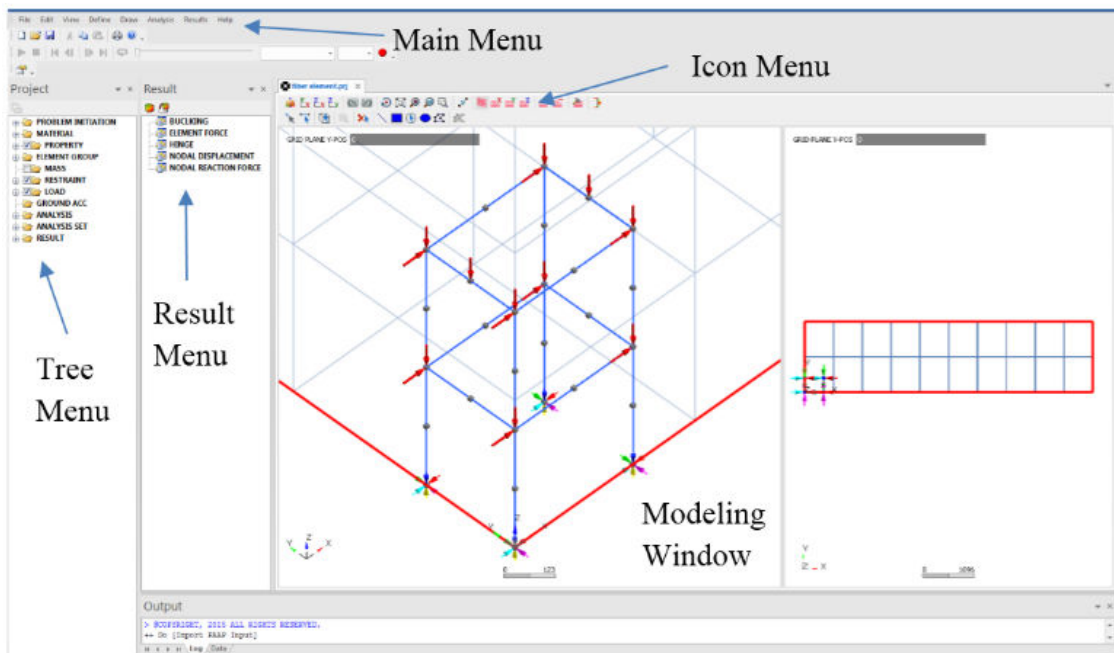

Fig. 3 Main graphic user interface

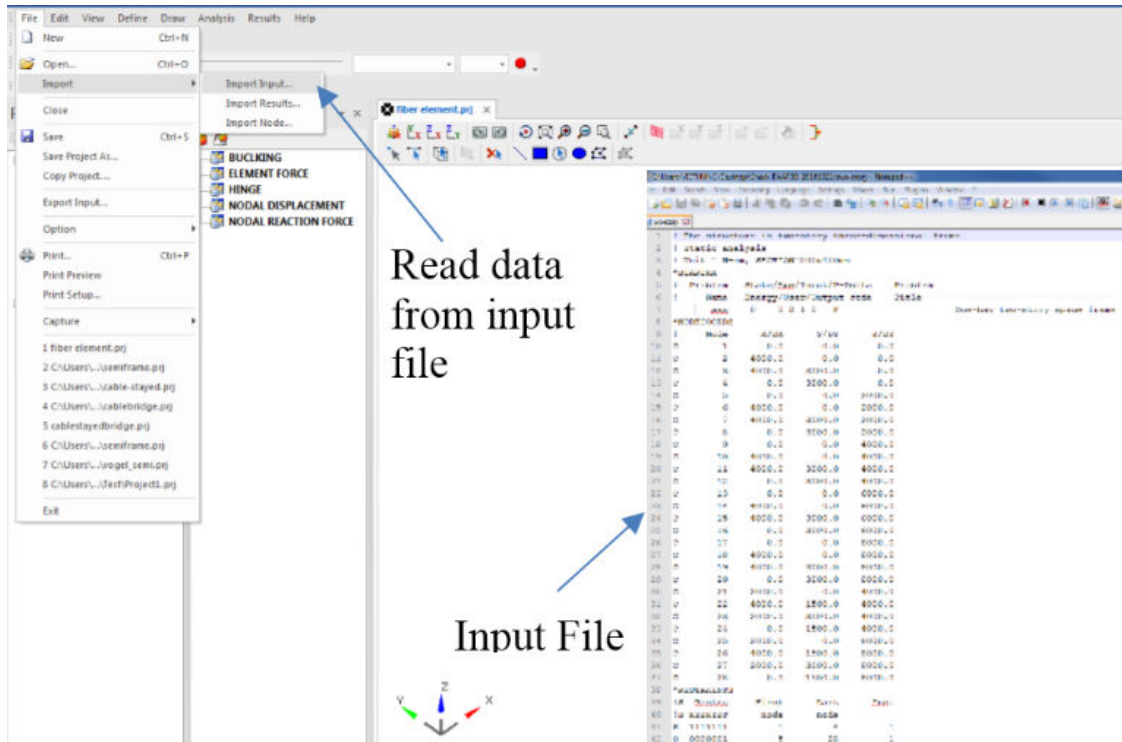

Fig. 4 Read data by using input file

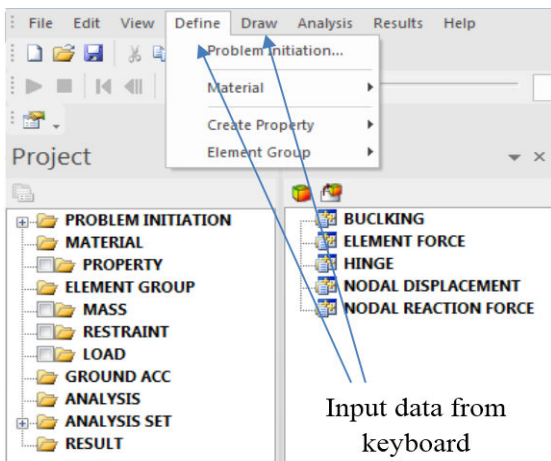

Fig. 5 Input data using keyboard

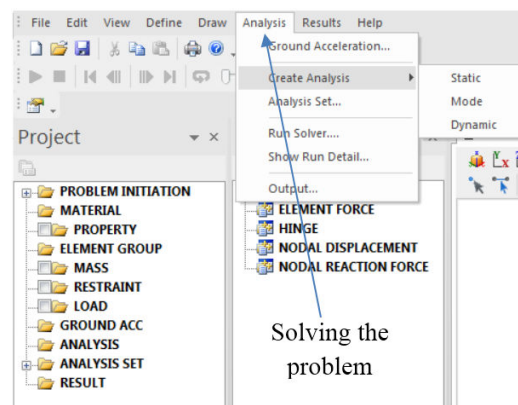

Fig. 6 Solving the problem

IV. CASE STUDY

C. Analysis and Result Presentation

The structure is solved by using the analysis menu as shown in Fig. 6. The results of analysis are then presented in the view window using the result menu as shown in Fig. 7. As can be seen in this figure, the analysis results of the nodal displacement and reaction force, element force, hinge, and buckling can be displayed in the post-processor. The option for animating structure deformation is also provided.

The two-story space steel frame with the applied load P of 140 kN is shown in Fig. 8. This frame was also analyzed by De Souza [12] by using the fiber-hinge concept.

In order to investigate the accuracy of the proposed software, the numerical results of current work using both beam-column and fiber-hinge beam-column elements are compared with those obtained by using ABAQUS and De Souza [12] as presented in Fig. 9. As can be seen in this figure, the comparison shows a good agreement.

Fig. 10 shows the performance of the proposed software in the case of using fiber-hinge beam-column element. In this figure, total deformation of the frame at the ultimate load factor of 0.8896 is shown on the left view window, while the structural

model is presented in the right view window. In addition, Figs. 11 and 12 show the nodal reaction forces of the frame at the ultimate load factor.

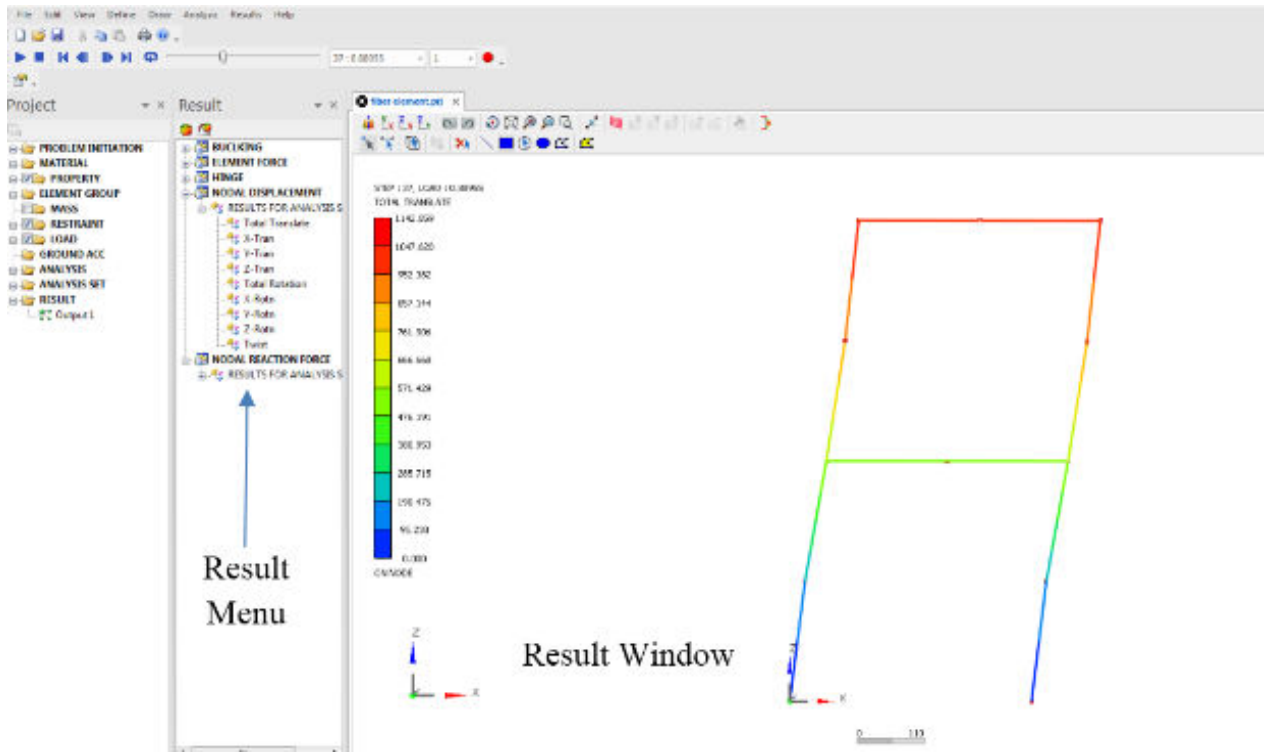

Fig. 7 Result performance

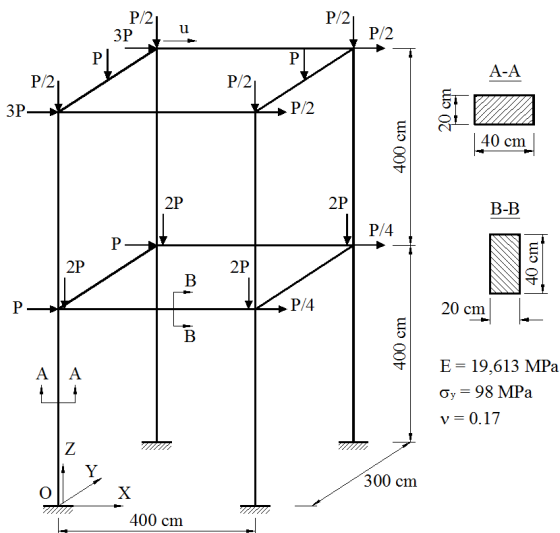

Fig. 8 Two-story space steel frame

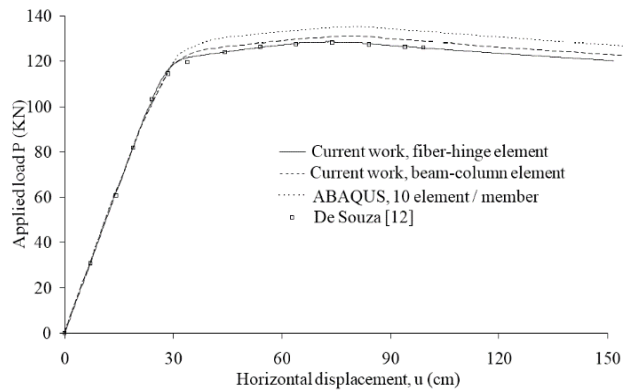

Fig. 9 Load-deflection curves of two-story space steel frame

V. CONCLUSION

The following points can be summarized from the present study:

- (1) A robust software is proposed for nonlinear inelastic analysis of space steel frames, where the solver is written in FORTRAN and the pre- and post-processors are developed using Visual C++.
- (2) Both plastic-hinge and fiber-hinge beam-column elements are provided in the proposed software for capturing the nonlinear inelastic behaviors of structure.
- (3) The results of the two-story space steel frame show that the

proposed software is accurate in analysis and user-friendly in using. Therefore, the proposed software can be applied

in practical design of steel frames.

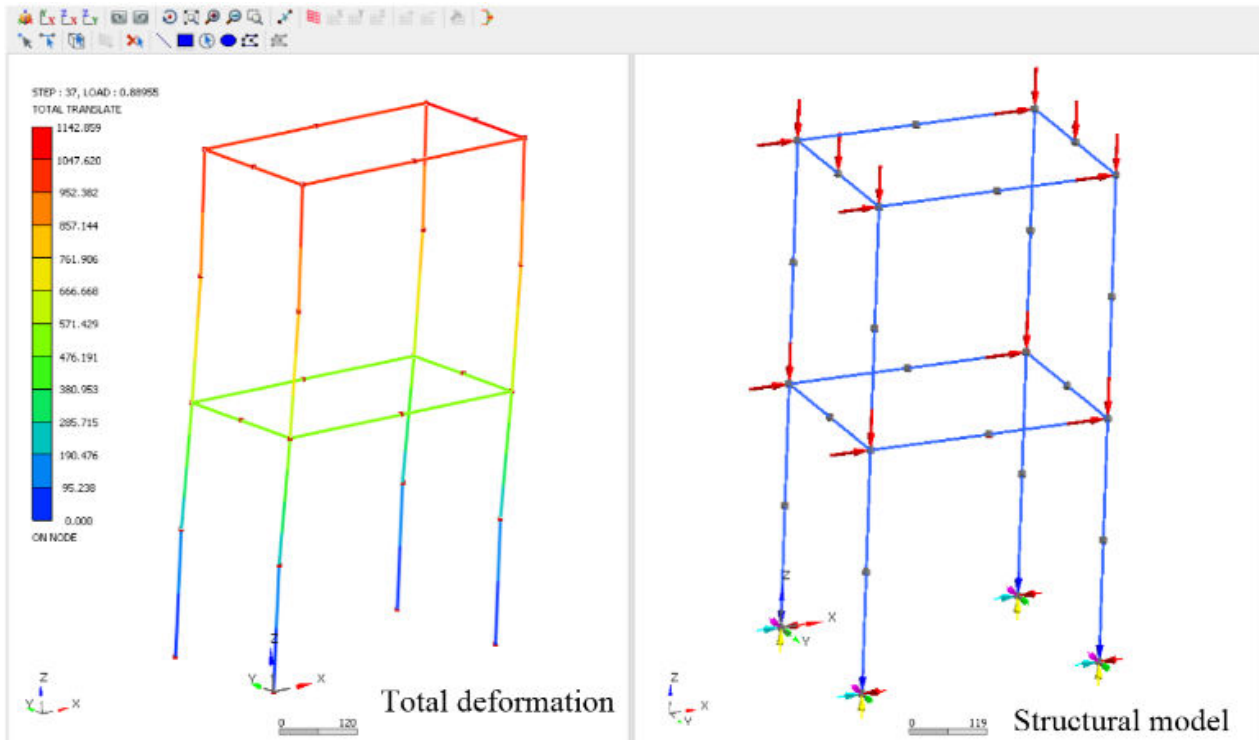

Fig. 10 Performance of proposed software of two-story space steel frame using fiber-hinge beam-column element

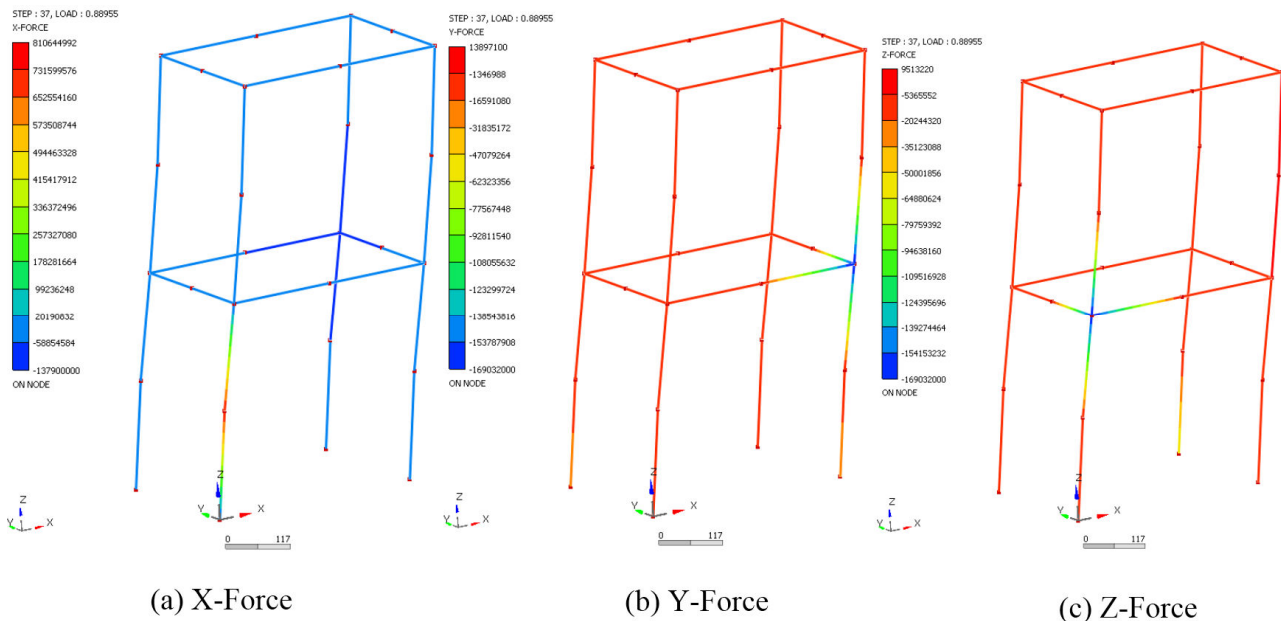

Fig. 11 Nodal reaction forces of two-story space steel frame using fiber-hinge beam-column element at the ultimate load factor

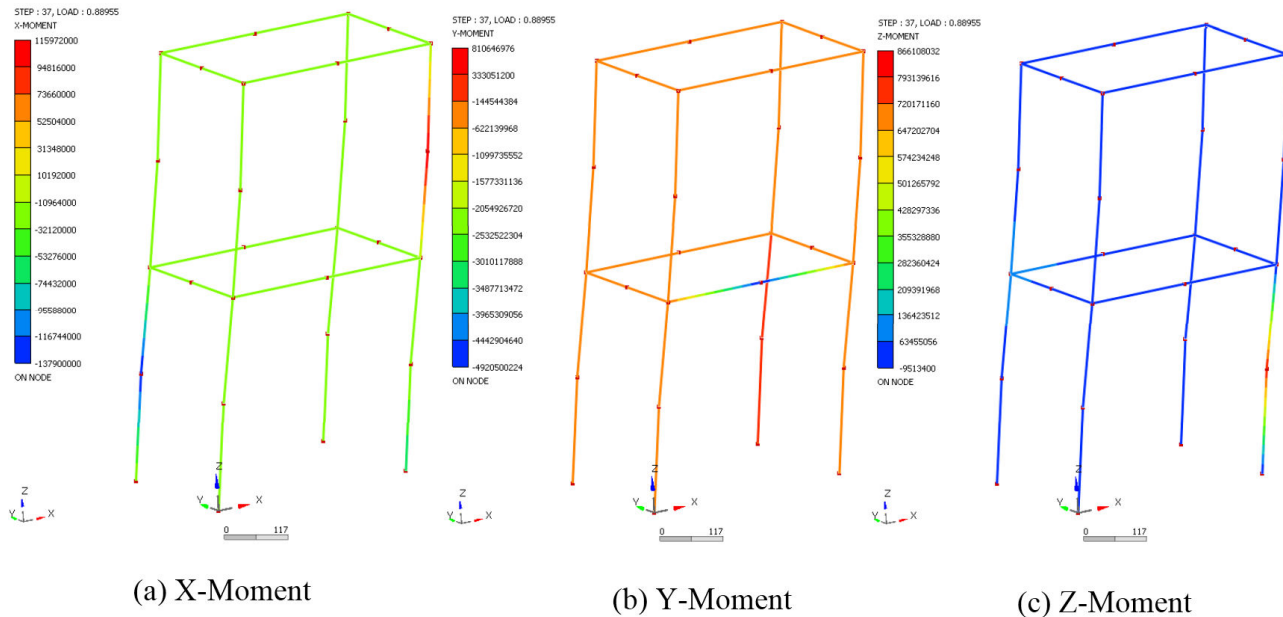

Fig. 12 Nodal reaction moments of two-story space steel frame using fiber-hinge beam-column element at the ultimate load factor

ACKNOWLEDGMENT

This work was supported by the National Research Foundation of Korea (NRF) grant funded by the Korean government (MSIP) (No.2011-0030040) and (No. 2015R1A2A2A01007339).

REFERENCES

- [1] L.H. Teh, M.J. Clarke, Plastic-zone analysis of 3D steel frames using beam elements, *J. Struct. Eng.* 125 (1999) 1328–1337.
- [2] W.F. Chen, S.E. Kim. *LRFD Steel Design Using Advanced Analysis*. CRC Press, Boca Raton, New York, 1997.
- [3] Truong VH, Nguyen PC, Kim SE. An efficient method for optimizing space steel frames with semi-rigid joints using practical advanced analysis and the micro-genetic algorithm. *Journal of Constructional steel research* 2017; 128: 416-427.
- [4] McKenna F, Fenves GL, et al. Open system for earthquake engineering simulation (OpenSees). Available from: <<http://opensees.berkeley.edu>>. Pacific Earthquake Engineering Research Center, University of California at Berkeley, 2005. Accessed on 21/10/2015.
- [5] Prakash V, Powell GH. *DRAIN-3DX: Base program user guide, version 1.10*. A computer program distributed by NISEE/Computer applications, Department of Civil Engineering, University of California at Berkeley, 1993.
- [6] Krishnan S, Hall JF. Modeling steel frame buildings in three dimensions. II: Elastofiber beam element and examples. *J Eng Mech ASCE* 2006; 132(4):359-374.
- [7] W.F. Chen, E.M. Lui. *Structural Stability: Theory and Implementation*, Elsevier, Amsterdam, 1987.
- [8] W.F. Chen, E.M. Lui. *Stability Design of Steel Frames*, CRC Press, Boca Raton, FL, 1992.
- [9] J.G. Orbison, W. McGuire, J.F. Abel, Yield surface applications in nonlinear steel frame analysis, *Comput. Methods Appl. Mech. Eng.* 33 (1) (1982) 557–573.
- [10] Thai HT, Kim SE. Practical advanced analysis software for nonlinear inelastic analysis of space steel structures. *Advances in engineering software* 2009; 40: 786-797.
- [11] Cuong NH, Kim SE. Practical nonlinear analysis of steel-concrete composite frames using fiber-hinge method. *J. of Constr. Steel Res.* 2012; 74: 90-97.
- [12] De Souza RM. Force-based finite element for large displacement inelastic analysis of frames. Ph.D. Dissertation, Department of Civil & Environmental Engineering, University of California at Berkeley, 2000.