

A High Accuracy Measurement Circuit for Soil Moisture Detection

Sheroz Khan, A. H. M. Zahirul Alam, Othman O. Khalifa, Mohd Rafiqul Islam, Zuraidah Zainudin, Muzna S. Khan, and Nurul Iman Muhamad Pauzi

Abstract—The study of soil for agriculture purposes has remained the main focus of research since the beginning of civilization as humans' food related requirements remained closely linked with the soil. The study of soil has generated an interest among the researchers for very similar other reasons including transmission, reflection and refraction of signals for deploying wireless underground sensor networks or for the monitoring of objects on (or in) soil in the form of better understanding of soil electromagnetic characteristics properties. The moisture content has been very instrumental in such studies as it decides on the resistance of the soil, and hence the attenuation on signals traveling through soil or the attenuation the signals may suffer upon their impact on soil. This work is related testing and characterizing a measurement circuit meant for the detection of moisture level content in soil.

Keywords—Analog–digital Conversion, Bridge Circuits, Intelligent sensors, Pulse Time Modulation, Relaxation Oscillator.

I. INTRODUCTION

THE increasing use of microprocessors and microcontrollers in measurement and data acquisition systems has enhanced the need for obtaining the transducer response in a form suitable for conversion to a digital format, obviously using suitable signal measurement and conditioning circuits. From this view point, it is desirable to obtain signals which are proportional representative of the changes in the parameter of interests. In resistive in resistive transducers changes in resistances are proportional to parameters that can be easily used for a useful applications in the industry. A simple resistance-to-frequency converter of high resolution has been recently reported, which uses a bridge amplifier, an integrator and a comparator as building blocks. In this project, it is shown that using the same building blocks connected in a different fashion, it is possible to obtain a time-period output linearly varying with changes in resistance. An analysis of the proposed circuit, discussed in the following sections, brings out its features and advantages over other related schemes.

The study of soil for agriculture purposes has remained the main focus of research since very long, however in recent works soil has been under the attention of researchers for reasons including transmission, reflection and refraction of signals for deploying wireless underground sensors network or for the monitoring of objects on soil in the form of better

understanding of soil electromagnetic characteristics properties [1-3]. The moisture content has been very instrumental in such studies as it decides on the resistance of soil, and hence the attenuation on signals traveling through soil or the attenuation signals may suffer during their impact on soil.

Measurement circuits are making fundamental components in both resistive and capacitive transducers designed and installed for monitoring parameters of interests [4-6], and such circuits have been reported recently with renewed content materials. However, limited range and resolution are the main topics which have been attracting interest among the researchers for deployment with sensitive applications [7-8].

In this paper a high accuracy measurement circuit, employing a bridge amplifier, an integrator, and a comparator, for detecting the moisture content of soil is suggested. This circuit has the advantage of detecting soil resistance with better accuracy and with wide-range linearity when compared with other similar works. The results shows a good level of linearity as it has been tested for voltages proportional to changes in resistances are very closely related with the measured values of voltages due to variations in a resistor from 950Ω to 2550Ω , and the results show a very much linear behavior.

The circuit used in this work is for detecting soil moisture content which is emulated as a variable resistor resulting into an RC circuit being charged up to a voltage level enough to turn the indicating LED ON. The features of the circuit are described in the experimental setup section, along with the discussions on the circuit in the discussion and analysis section.

II. EXPERIMENTAL SETUP

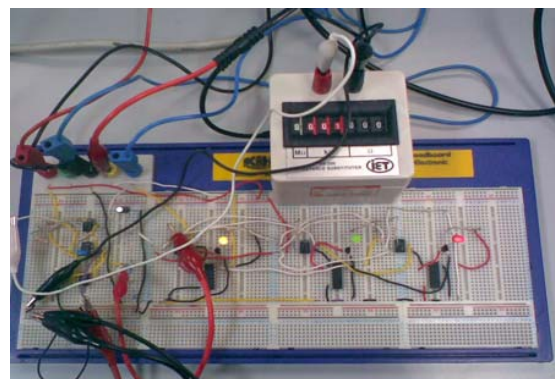

Fig. 1 Experimental Setup

Authors are with Faculty of Engineering, International Islamic University Malaysia (IIUM) P. O. Box. 10, 50728 Kuala Lumpur, Malaysia (e-mail: sheroz@iiu.edu.my).

The experimental setup of Fig. 1 is in fact an implementation of the schematic shown in Fig. 2. The whole circuit is divided into three well distinct blocks – measurement Circuit, RC delaying circuit and control circuit.

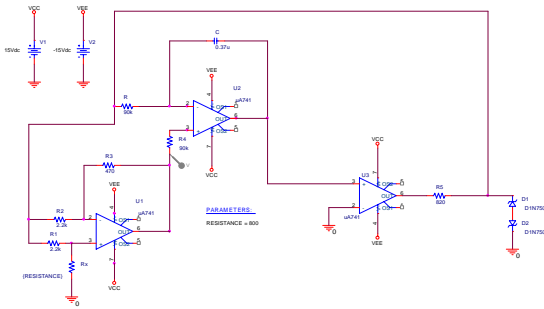

Fig. 2 Basic Circuit Converting Resistance Changes into Time-Period Changes

The measurement portion (Fig. 2) translates changes in resistances in to changes in time period of the resulting square wave, while the control units (Fig. 3) functions to charge the RC capacitor up to a proportionate level of voltage, which in turn is realized by the control circuit to accordingly turn the LEDs ON/OFF for the required indication of soil moisture content. The components values are chosen so that the voltage level is reached through a fully charged capacitor in the HIGH part of the square wave, and which in turn is not able to discharge in the LOW part of the square wave.

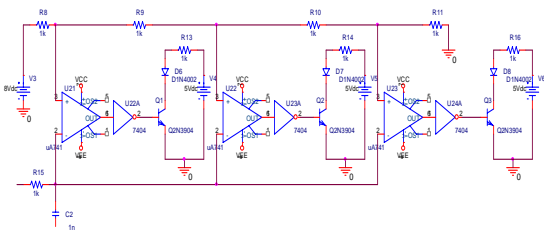

Fig. 3 Circuit Controlling Indication of LEDs

The circuit also possesses a high order of resolution and linearity as the resistance-to-frequency converter. These features, along with the absence of the need for providing a compensation arrangement and facility of having a grounded sensor, should favor the application of the proposed circuit for signal-conditioning of resistive transducers. The first OP-AMP of Fig. 2 outputs the voltage value with different R_x values, while the second OP-AMP is a differential amplifier. This differentiates the output waveform coming from OP-AMP1. The third OP-AMP outputs the differentiated waveform.

The circuit functions as a square wave oscillator when the bridge is unbalanced, with voltage at node, V_a and output voltage, V_o having the same polarity.

III. EXPERIMENTAL RESULTS

The waveforms of comparator input, V_c and output, V_o are as shown in Fig. 4 (a-f).

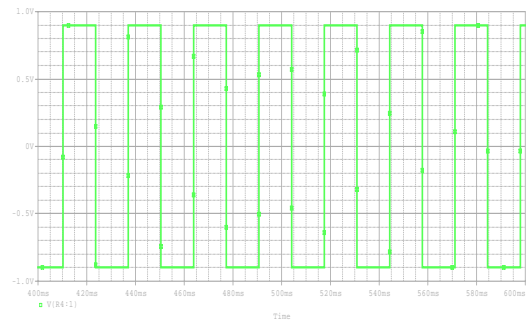

Fig. 4 (a) For $R_x = 1k\Omega$, the output waveform of OP-AMP1

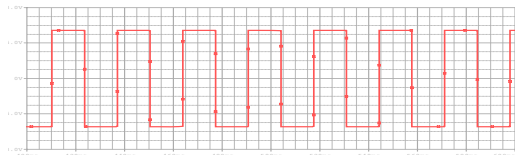

Fig. 4 (b) Resulting Waveform of V_o

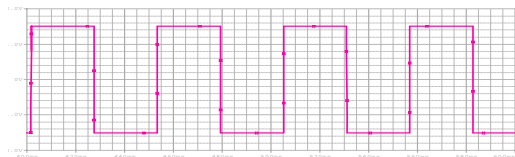

Fig. 4 (c) For $R_x = 1.4k\Omega$, the output waveform of OP-AMP1

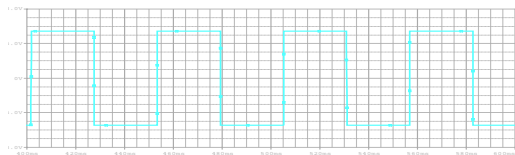

Fig. 4 (d) Resulting Waveform of V_o

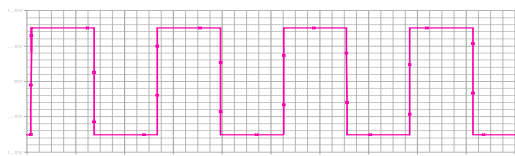

Fig. 4 (e) For $R_x = 2k\Omega$, the output waveform of OP-AMP1

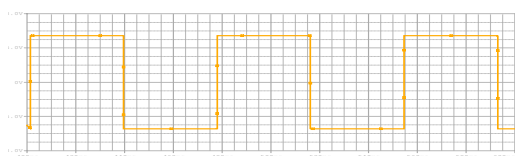

Fig. 4(f) Resulting Waveform of V_o

As you can see from the output waveforms, changes in time-period lead to proportional changes in R_x .

IV. ISSUES OF LINEARITY AND SENSITIVITY

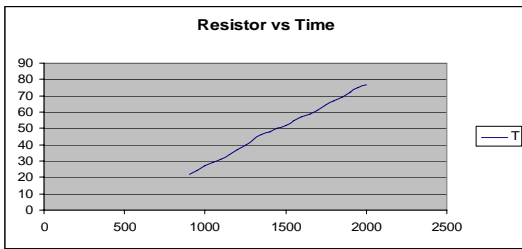

Fig. 5(a) Experimental Results Showing a Linear Response of the Circuit

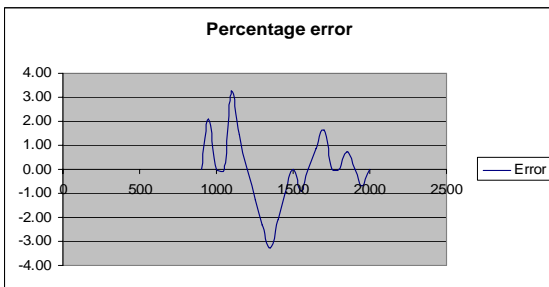

Fig. 5(b) Errors in Experimental Results with an Ideal Linear Response of the Circuit

The measurement circuit shows up a good linearity (Fig. 5 a-b) as R_x is increased from 900Ω to 2000Ω in a step of 50Ω . This graph also verifies a direct proportionality between R_x and the time period of V_0 .

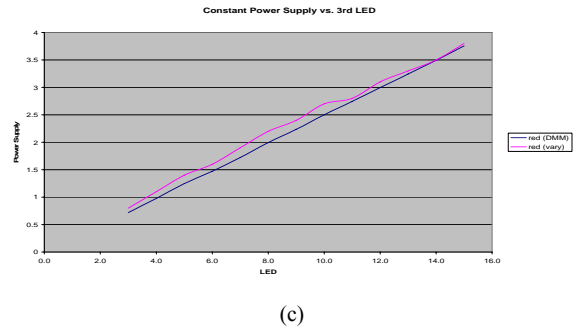

Fig. 6 The voltages across the three LEDs for varying R_x values

The power supply to the LED circuit is tested to see the effect of changing the supply voltage, which shows that as the supply voltage is increased, the voltage level at which the LED's lit up was also increased. The same was repeated with the changes in R_x , and it was shown to be very much in linearity with the power supply variations. The voltages across the three LEDs for varying R_x values, is shown through Fig. 6 (a-c), which justifies the linearity behavior of the suggested measurement circuit. The values in the table confirm that the relationship between the value of the capacitance and the time period is linear. As the capacitance value increased, the time period also increased at certain amount.

The measurement circuit is further used as a soil moisture detector. As we know, the moisture in the soil could serve as an element that could add to the conductivity of soil. The higher the conductivity, the less the resistance of soil in a container, that is used to replace R_x of soil. The procedure used in this work is to show through turning ON an LED for a value of resistance over a certain range of resistance, for example, turning one LED ON for one level of moisture content, two LED's should light for a higher level, and three LEDs up for the highest level of moisture content. The output waveform agrees (if not completely) with the one shown for the value of R_x . Hence, we can conclude that our project can be applied to the usage of a soil moisture detector.

V. CONCLUSION

The results are obtained by the proposed measuring circuit with soil moisture contents have been presented, which demonstrate that the voltage across the RC circuit is proportional to variations in the soil resistance (or moisture content). A comparison between measured values and the voltage values as a result of the measuring circuit shows a good level of linearity. The results achieved are varying as the value of V_0 varies directly with increased values of the time period of the square wave, as different values of R_x led to proportionately increased values of voltage across the capacitor, hence leading to lighting up the LEDs at different timings. The different values of moisture content will lead to different values of soil resistance, and hence accordingly varying values of voltages across the RC circuit. Their conductance/resistance will be measured by putting the probes/wires into the samples and the output voltage will be

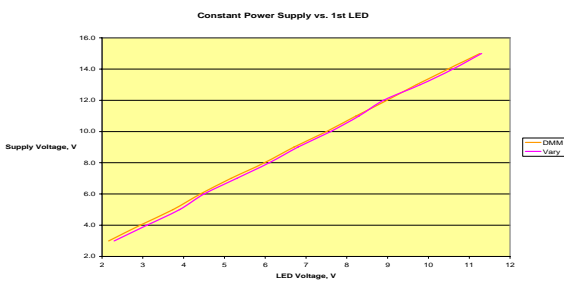

(a)

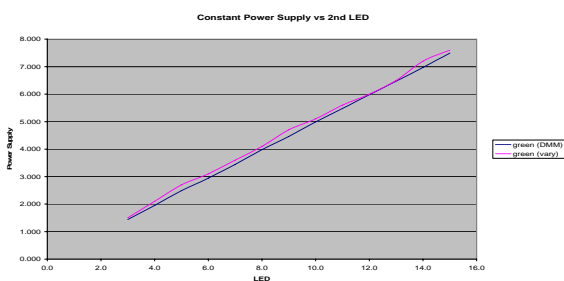

(b)

observed using the oscilloscope. We are also plan to measure the conductivity value of certain soil. For example, we use only one particular soil sample, and by adding little by little water to measure its conductance value at certain level of moisture.

REFERENCES

- [1] Peter Arzberger, University of California at San Diego , Sensors for Environmental Observatories, Report of the NSF-Sponsored Workshop December 2004
 - [2] R.A Carleyl & E. Heggy, "Characterization of the Density Dependent Dielectric Properties of Mars-Like Soils: Implications For Mars Radar Studies," University of Cambridge, United Kingdom, Lunar and Planetary Science XXXVII (2006), Lunar and Planetary Institute, 3600 Bay Area Boulevard, Houston
 - [3] Jatupum Jenwatanavet and Joel T. Johnson, Member, IEEE, "An Analytical Model for Studies of Soil Modification Effects on Ground Penetrating Radar", IEEE Trans. on Antennas and Propagation, vol. 49, no. 6, June 2001
 - [4] K. Mochizuki and K. Watanabe, "A high-resolution, linear resistance-to-frequency converter," IEEE Trans. Instrum. Meas., vol. 45, pp. 761–764, 1996.
 - [5] Vittorio Ferrari, Carla Ghidini, Daniele Marioli, and Andrea Taroni, "Oscillator-Based Signal Conditioning with Improved Linearity for Resistive Sensors," IEEE Transactions on Instrumentation And Measurement, Vol. 47, No. 1, February 1998
 - [6] S. Kaliyugavaradan, "A Linear Resistance-To-Time Converter with High Resolution," IEEE Trans. Instrum. Meas., Vol. 49, no. 1, February 2000.
 - [7] Kouji Mochizuki, Kenzo Watanabe, Fellow, IEEE, Takashi Masuda, and Motoyasu Katsura, "A Relaxation-Oscillator-Based Interface for High-Accuracy Ratio-metric Signal Processing of Differential-Capacitance Transducers," IEEE Trans. on Instrum., vol. 47, no. 1, February 1998
 - [8] Satish Chandra Bera, Jayanta Kumar Ray, and Subrata Chattopadhyay, "A Low-Cost Noncontact Capacitance-Type Level Transducer for a Conducting Liquid," IEEE Trans. Instrum. Meas. vol. 55, no. 3, pp. 778-786, June 2006.
- SheroZ Khan** obtained a B Sc in Electrical Engineering from the NWFP University of Engineering and Technology (UET), Peshawar, Pakistan. He obtained his M Sc.in Microelectronics & Computer Engineering from the University of Surrey, UK. He obtained Ph D in Electrical Engineering from the University of Strathclyde (Scotland), 1994, UK. He worked on switching sequence generation in a coordinated Control and Protection environment using Artificial Intelligence (AI) techniques produced an Expert System for switching sequence generation of SCADA, which was recognized for the award of a Ph D degree. Mr Khan is currently working as Associate Professor within the department of Electrical and Electronic at the International Islamic University Malaysia, and has published five journal papers and over 50 conference articles. He is sponsored by the grants of the Ministry of Science and Technology Malaysia.
- A. H. M. Zahirul Alam** received the B.Sc. and M.Sc. degrees in Electrical and Electronic Engineering from Bangladesh University of Engineering and Technology (BUET) in 1984 and 1987, respectively. He obtained his Dr. Engg. from Kanazawa University, Japan in 1996. He was working as a faculty member in BUET from 1985 to 1991 and from 1996 to 2002. He is currently faculty member of Electrical and Computer Engineering Department, International Islamic University Malaysia (IIUM). His research interest includes electronic device modeling and fabrication, RF devices and MEMS, antenna and communication devices.
- Othman O. Khalifa** received his Bachelor's degree in Electronic Engineering from the Garyounis University, Libya in 1986. He obtained his Master degree in Electronics Science Engineering and PhD in Digital Image Processing from Newcastle University, UK in 1996 and 2000 respectively. He obtained his Master degree in Electronics Science Engineering and PhD in Digital Image Processing from Newcastle University, UK in 1996 and 2000 respectively. He worked in industrial for eight years and he is currently an Associate Professor and Head of the department of Electrical and Computer Engineering, International Islamic University Malaysia. His area of research interest is Communications, Information theory and Coding, Digital image / video and speech processing, coding and Compression, Wavelets, Fractal and Pattern Recognition. Dr Khalifa published more than 100 papers in international journals and Conferences. He is SIEEE member, IEEE computer, Image processing and Communication Society member.
- Rafiqul Islam** received his B. Sc. (Electrical and Electronic Engineering) from BUET, Dhaka in 1987. He received his MSc and PhD both in Electrical Engineering from UTM in 1996 and 2000 respectively. He is Fellow of IEB and member of IEEE. He is currently faculty member of Electrical and Computer Engineering Department of International Islamic University Malaysia. His area of research interest are radio link design, RF propagation measurement and RF design, smart antennas and array antennas design etc.