

A Development of Home Service Robot using Omni-Wheeled Mobility and Task-Based Manipulation

Hijun Kim, Jungkeun Sung, Seungwoo Kim

Abstract—In this paper, a Smart Home Service Robot, McBot II, which performs mess-cleanup function etc. in house, is designed much more optimally than other service robots. It is newly developed in much more practical system than McBot I which we had developed two years ago. One characteristic attribute of mobile platforms equipped with a set of dependent wheels is their omni-directionality and the ability to realize complex translational and rotational trajectories for agile navigation in door. An accurate coordination of steering angle and spinning rate of each wheel is necessary for a consistent motion. This paper develops trajectory controller of 3-wheels omni-directional mobile robot using fuzzy azimuth estimator. A specialized anthropomorphic robot manipulator which can be attached to the housemaid robot McBot II, is developed in this paper. This built-in type manipulator consists of both arms with 3 DOF (Degree of Freedom) each and both hands with 3 DOF each. The robotic arm is optimally designed to satisfy both the minimum mechanical size and the maximum workspace. Minimum mass and length are required for the built-in cooperated-arms system. But that makes the workspace so small. This paper proposes optimal design method to overcome the problem by using neck joint to move the arms horizontally forward/backward and waist joint to move them vertically up/down. The robotic hand, which has two fingers and a thumb, is also optimally designed in task-based concept. Finally, the good performance of the developed McBot II is confirmed through live tests of the mess-cleanup task.

Keywords—Holonomic Omni-wheeled Mobile Robot, Special-purpose, Manipulation, Home Service Robot

I. INTRODUCTION

SERVICE robotics is expected to play actual and important role in complex domestic environments. To really do that, the most optimal kinematics of the two-arm humanoid robot, to mount manipulators on wheeled mobile platforms, should be designed [1]. In this paper, a Smart Home Service Robot, McBot II, is newly developed in much more practically kinematic system than McBot I which we had developed 2 years ago.

If Home Service Robots, a kind of personal robot for work, amusement, and homeschooling are widely studied these days.

The cleaning robot is a product of home service robots. The cleaning robot is also an electric home appliance, which is developed on the basis of the wheel-based mobile robot in the same method as a vehicle robot for factory automation and a

guidance robot [2]. The vacuum-cleaner was developed in the 1950s to aid in the manual cleaning of houses, which had been the most dominant household chore. It has lightened the burden of household chores but the operational labor involved in vacuum-cleaners has been very severe. Recently, a cleaning robot was commercialized to perfectly address the issue of labor in the cleaning of houses but it also was not successful because it still had a problem in mess-cleanup, namely, the clean-up of large trash and the arrangement of newspapers, clothes, etc. The cleaning robot just vacuums dust and small trash and has no capability for arranging and taking away large trash prior to the automatic vacuum-cleaning. For this reason, the market for the cleaning robot has not yet been built up actively. Hence, we need a design method and technical algorithm for a new automatic machine to solve the problem of mess-cleanup in houses. In this paper, a home Mess-Cleanup Robot II (McBot II), which has the practical functionality of automatic mess-cleanup on real environments, is developed.

Home service robot needs not only its precise control but also optimization of kinematic design because it is together with the humans. McBot I, which we had developed in a prototype service robot for mess-cleanup, has small height (722) and short arm (698). The height of the dining table or the sink, which is daily necessity in the house, is generally about 800–850. Overall, the practical home service robot for household chores such as mess-cleanup should be much taller than the one of McBot I. But that is burdensome for the control of the main wheels and motors on the base frame of the robot. So, optimal kinematic design is needed in McBot II. The optimal design is also needed in width and depth which is derived into an area of the base frame. There are so many obstacles in house space which is not so large. The optimization is that a maximum number of mechanical and electronic components should be equipped on the minimum area of base frame of McBot II. The third optimization is on the design of waist and arm of robot. The mechanical waist and arm which resemble the human can make efficient functions. But waist as human's can make variable centroid when it operates, and the long robot arm gives a big burden for the shoulder. Those also make control of the robot difficult. A new idea needs in the kinematic design of the mechanical waist and arm. Therefore, three kinds of optimization should be solved. The optimal kinematic design for McBot II is proposed in this paper.

McBot II needs functions of agile navigation and novel manipulation system for household chores. The autonomous navigation system has to be controlled for the full scanning of living room and for the precise tracking of the desired path. In this paper, a Swedish OWMR is, with a proposal of new control algorithm, developed as a holonomic mobile robot. The trajectory control of OWMR is so difficult because it has much more uncertainty than conventional WMR. The dynamic

Seungwoo Kim is with Department of Electric and Robotic Engineering, Soonchunhyang University, Asan, Chungnam, Korea (phone: 041-530-1369; e-mail: seungwo@sch.ac.kr).

Hijun kim is with Department of Electric and Robotic Engineering, Soonchunhyang University, Asan, Chungnam, Korea (e-mail: june0909@empas.com).

Jungkeun Sung is with Department of Electric and Robotic Engineering, Soonchunhyang University, Asan, Chungnam, Korea (e-mail: popayata@hotmail.com).

equation is nonlinear and time-varying in the extreme. Thus, this paper presents accurate trajectory control method of 3-wheels omni-directional mobile robot using fuzzy azimuth estimator. The OWMR of this paper has three omni-directional wheels, arranged 120 deg apart. Each wheel is driven by a DC motor installed with an optical shaft encoder. A gyro sensor is used for the perception of azimuth. It is controlled by independent PID law for each motor to follow the speed command from inverse kinematics without considering the coupled nonlinear dynamics explicitly in the controller design. The trajectory controller needs a precise sensing data of its azimuth and exact estimation of reference azimuth value. It has imprecision and uncertainty inherent to perception sensors for azimuth. The imprecision is made by sensor noise and aliasing. The uncertainty consists of disturbance and slip of mobile robot. In this paper, they are solved by using fuzzy logic inference which can be used straightforward to perform the control of the mobile robot by means of the fuzzy behavior-based scheme already existent in literature. Also, it is perfectly implemented on the 3-wheels OWMR developed in this paper

McBot II needs dexterous manipulation capability. Robot arm is divided into general purpose and special purpose. Both of them have such design parameters as workspace, range of joint angle, joint torque, link length and arm mass. Most of special-purpose arms for service robot is developed in built-in type. These built-in arms cannot help being finitely designed on link length and joint torque, and are always implemented to cooperate between both ones. They cause workspace of arms smaller. Nevertheless, enough workspace to perform tasks of home service robot must be secured. So, this paper proposes a novel design strategy of the built-in type arms. The new joints installed on the neck are used to get adequate horizontal workspace on the working floor. Finally, its good performance is confirmed through live test of tasks.

II. KINEMATIC DESIGN OF MCBOT II

Home service robot needs not only optimization of kinematic design but also its precise control because it is together with the humans. McBot II, which performs mess-cleanup function etc. in house, is designed much more optimally than other service robots. Home service robot for household chores is designed by the optimization facts as the below.

- ① Optimum size of height, width and depth of robot
- ② Optimum variation of the robot's centroid point
- ③ Optimum kinematics of the robot's waist and arm

Home service robot must efficiently operate also in the standing life style such as council board, dining table and the sink. The height of the dining table or the sink, which is daily necessity in the house, is generally about 800–850. The practical home service robot for household chores such as mess-cleanup should be much taller than the one of McBot I which we had developed in a prototype service robot for mess-cleanup. But optimal kinematic design is needed in McBot II because that is burdensome for the control of the main wheels and motors on the base frame of McBot II. The optimal design is also needed for the area of base frame of service robot.

The third optimization is on the design of waist and arm of home service robot. The robotic waist and arm as the human's can make efficient functions. But the robotic waist makes variable centroid when it operates, and the long arms make a big burden on the shoulder. Those also give the service robot difficulty of control. Therefore, three kinds of optimization should be solved in this paper. McBot II is divided into 4 key parts such as shoulder, manipulation, body and navigation. Its appearance is shown in Fig.1.

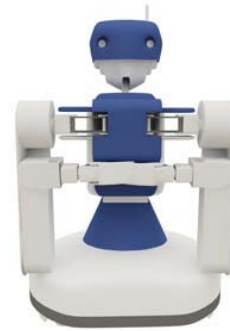

Fig. 1 Appearance of McBot II

III. TRACKING CONTROL AND FUZZY ESTIMATOR

This section represents accurate trajectory control method of 3-wheels omni-directional mobile robot using fuzzy azimuth estimator. The OWMR of this paper has three omni-directional wheels, arranged 120 deg apart. Each wheel is driven by a DC motor installed with an optical shaft encoder. A gyro sensor is used for the perception of azimuth. It is controlled by independent PID law for each motor to follow the speed command from inverse kinematics without considering the coupled nonlinear dynamics explicitly in the controller design. The controller structure using fuzzy azimuth estimator is shown in the Fig. 2. The state and output equations [3] are described in the absolute coordinate system. It should be noted, however, that the control input is the quantity in the moving coordinate system.

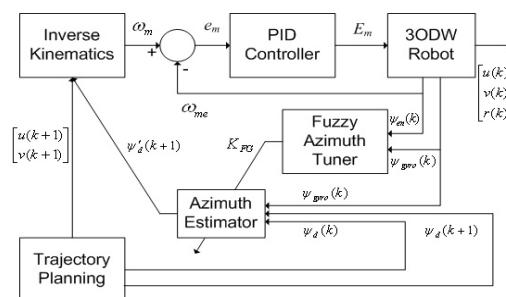

Fig. 2 The Tracking Control Structure

Therefore, the control input in the absolute coordinate system must be transformed into the control input for each assembly, i.e., signal expressed in the moving coordinate system, if the control input is designed in the absolute coordinate system. Then, the transformation for each input can be derived from kinematics as follows.

$$\begin{bmatrix} \dot{x} \\ \dot{y} \\ \dot{\psi} \end{bmatrix} = \begin{bmatrix} \cos \psi(k) & -\sin \psi(k) & 0 \\ \sin \psi(k) & \cos \psi(k) & 0 \\ 0 & 0 & 1 \end{bmatrix} \begin{bmatrix} u \\ v \\ r \end{bmatrix} \quad (1)$$

A trajectory controller for an omni-directional mobile robot needs a precise sensing data of its azimuth and exact estimation of reference azimuth value. It has imprecision and uncertainty inherent to perception sensors for azimuth. The imprecision is made by sensor noise and aliasing. The uncertainty consists of disturbance and slip of mobile robot. As we can see in Fig. 2, they are solved by using fuzzy logic inference which can be used straightforward to perform the control of the mobile robot by means of the fuzzy behavior-based scheme already existent in literature. The new enhancement azimuth is derived as equation (2).

$$\psi'_d(k+1) = \psi_d(k+1) + K_{FG}(\psi_d(k) - \psi_{gyro}(k)) \quad (2)$$

$\psi_d(k)$ is the k th azimuth angle computed from trajectory planning, $\psi_{gyro}(k)$ is the k th output of gyro sensor and $\psi'_d(k+1)$ is new value of the $(k+1)$ th azimuth. Its gain K_{FG} is in real-time tuned by fuzzy azimuth tuner of Fig. 3.

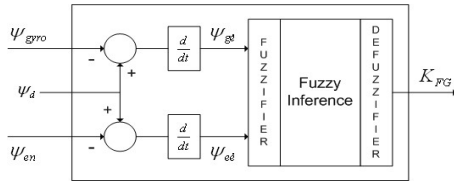

Fig. 3 Fuzzy Azimuth Tuner

Mamdani's inference engine is used in fuzzy azimuth tuner. Input signal is change rate of error between desired azimuth and gyro/encoder sensors. Output is gain of azimuth estimator K_{FG} . Fuzzy rule base of linguistic variables is given in Table 1.

TABLE I
FUZZY RULE BASE

Change Rate of Error		ψ_{ge}		
		NE	ZE	PE
ψ_{ec}	NE	PB	PS	NS
	ZE	PS	ZE	NS
	PE	PS	NS	NB

IV. TRACKING CONTROL AND FUZZY ESTIMATOR

This paper proposes a novel design strategy of the built-in type arms. The new joints installed on the neck are used to get adequate horizontal workspace on the working floor. The lift-typed joint installed on the waist is used to get adequate vertical workspace on the working floor. Its mechanism is explained in the Fig. 4.

The built-in type hands of home service robot must be mechanically designed in task-oriented system. Task-based design of hands cannot help making the DOF so high. It has great difficulties to install a lot of actuators and coupling devices on the restricted space. So, this paper proposes optimal design method to satisfy both minimum DOF and maximum work efficiency. This hand consists of two fingers and a thumb

where the finger mechanism is well designed for grasping typical objects stably in human's daily activities such as sphere and cylinder shaped objects. The restriction of possible motions and the limitation of grasping objects arising from the reduction of DOF can be overcome by reflecting the cooperation technique of both hands and tasks-extracted motion profile to design procedure.

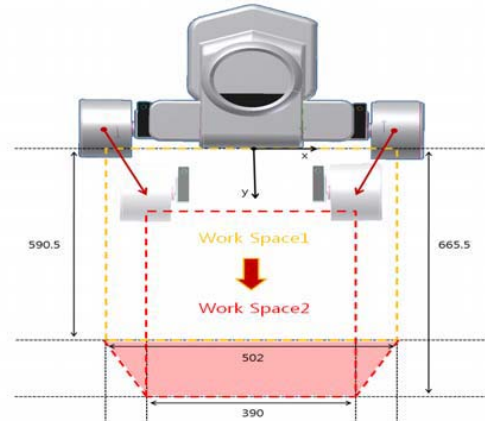

(Horizontal WS : 509.5 x 502 Vertical WS : 509.5 x 390)

Fig. 4 Optimal Design Mechanism of Built-in Both Arms-

The actual mechanism used 4-bar-link finger and Dustin type finger. 4-bar-link method is explained in Fig.5. Joint points C, D, E can be moved on the base of actuating point A and fixed point B. As a result, the developed hand can imitate not only human hand's shape but also its motion in a compact and efficient manner.

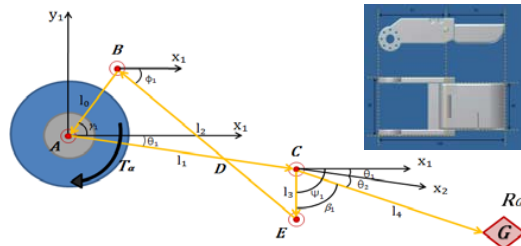

Fig. 5 Optimal Design Mechanism Using 4-Bar-Finger

In this paper, an optimal design method to overcome the directly-opposed problem between the minimum mechanical size and the maximum workspace by using neck joint to move the arms horizontally forward/backward and waist joint to move them vertically up/down, is proposed. The robotic hand, which has two fingers and a thumb, is also optimally designed in task-based concept. The Specifications of the developed built-in manipulator are listed in the table 2.

TABLE II
SPECIFICATIONS OF MANIPULATRO

Total Length	874 mm	Motor I	EX-106(106kgf)
Total Width	590 mm	Motor II	EX-64(64kgf.cm)
Arm Weight	2.11 kg	Motor III	EX-28(64kgf.cm)
Actuators	16(up/fore/han)	Material	ApexPA2,AL707

V. RESULT AND CONSIDERATIONS

We develop a new home mess-cleanup robot, McBot II in this paper. Dimensions of McBot II are 440 x 560 x 1100. The height of the lift is set to 700. A robot that includes all the above features is optimally implemented. For convenience in experimentation, the floor of the living room is of the size, 2400 x 4800. To precisely control it, this paper proposes a new architecture of control system. Its configuration is shown in Fig.6.

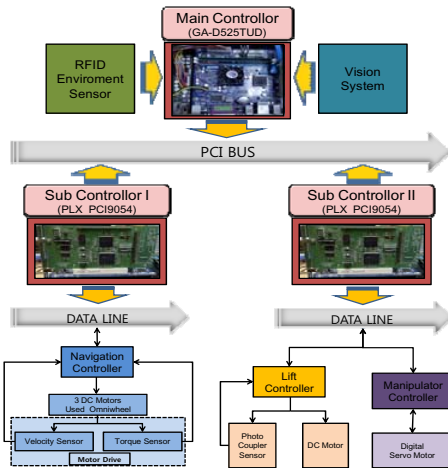

Fig. 6 Control System Configuration of McBot II

The built-in type manipulator, which was developed for the special purpose of mess-cleanup in door, consists of both arms with 3 DOF (Degree of Freedom) each and both hands with 3 DOF each. The robotic arm is optimally designed to satisfy both the minimum mechanical size and the maximum workspace. Minimum mass and length are required for the built-in cooperated-arms system. But that makes the workspace so small.

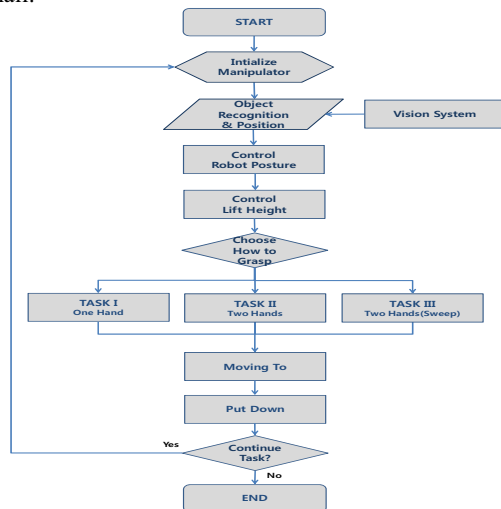

Fig. 7 Control Flowchart for Task-based Manipulation

This paper optimally has designed method to overcome the problem by using neck joint to move the arms horizontally forward/backward and waist joint to move them vertically up/down. The robotic hand, which has two fingers and a thumb,

is also optimally designed in task-based concept. The control flowchart of robot arms and hands is shown in Fig.7.

A mobile robot with three omni-directional wheels is developed for the precise mobility of McBot II. The DC motor which the rated torque is 31Kg-cm is used for driving the omni-directional wheeled mobile robot. The diameter of omni-directional wheel is 79mm and the distance from center point of robot to wheel is 198mm. Fig.8 shows that the peak tracking error (difference between the trajectory command and the robot response) is under 10^{-2} m bound and the orientation angle tracking error is less than 3deg. It should be noted that both are achieved on the same order with and without a robot self-rotation. This shows that the trajectory method of mobile robot using fuzzy azimuth estimator has robustly controlled parametric uncertainty of the target system.

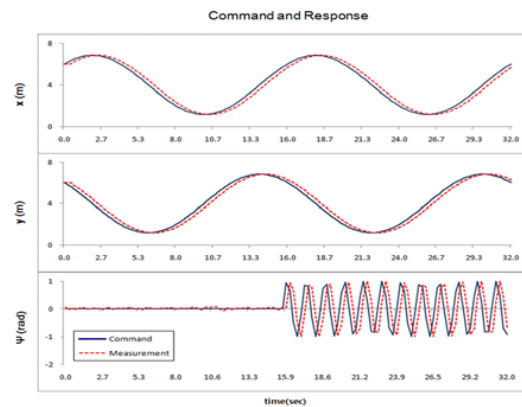

Fig. 8 Position(x,y) and Orientation(ψ) Response

VI. CONCLUSION

A home service robot, McBot II, which has the practical functionality of automatic mess-cleanup on real environments, is developed in this paper. This paper has proposed not only optimization of kinematic design but also its precise controller to offer better service for the humans. A holonomic mobile robot using 3 omni-directional wheels and a specialized anthropomorphic robot manipulator was developed in this paper. Also, the good performance of the developed mobile robot is confirmed through live tests of mess-cleanup task.

REFERENCES

- [1] Bischoff R. HERMES – A Humanoid Mobile manipulator for service Tasks. In: Proceedings of the FSR'97 Conference on Field and Service Robots, 1997; pp 508-515.
- [2] Connette CP, Pott A, Hägele M, Verl A. Control of an Pseudo-Omnidirectional, Non-Holonomic, Mobile Robot based on an ICM Representation in Spherical Coordinates. In: Proceedings of the 47th IEEE conference on Decision and Control, 2008; pp 4976-4983.
- [3] Campion G, Bastin G. Structural Properties and Classification of Kinematic and Dynamic Models of Wheeled Mobile Robots. IEEE Transactions on Robotics and Automation, 1996; 12(1): pp 47-62.
- [4] K. Harada et al., "Dynamics and Balance of a Humanoid Robot during Manipulation Tasks," IEEE Trans. on Robotics, vol. 22, No. 2, 2006, pp. 568-575
- [5] Matsunaga N, Kawaji S. Hybrid controller with fuzzy and PD control. In: Proceedings of IEEE International Workshop Advanced Motion Control, Kumamoto, 1990; pp 99-106