

A Critical Review on the Development of a Theoretical Framework for Managing Environmental Impacts of Construction Project

Sami Mustafa M. E. Ahmed, Noor Amila Wan Abdullah Zawawi, Zulkipli B. Ghazali

Abstract—Construction industry is considered as one of the main contributor of natural resources depletion, responsible for high level pollution and it is one of the attributes that pose climate changes and other environmental threats. A lot of efforts had and have been done to reduce and control these impacts. Project Environmental Management (PEM) includes the processes required to ensure that the impacts of the project execution to the surrounding environment will remain within the limits stated in legal permits. The main aim of most of researches conducted managing Environmental Impacts (EI) is to protect earth planet from pollution. Those researches are presenting four major environmental elements; Environmental Management Systems (EMS), Environmental Design (ED), Environmental Planning (EP) and Environmental Impacts Assessments (EIA). Although everything has been said about environmental management for construction projects, but almost everything remains to be said and therefore to be explored or rediscovered because incontestably, almost everything remains to be done. This paper aimed at reviewing some of what has been said about PEM. Also one of its objectives is to explore and rediscover the whole view of managing the EI problems by proposing a framework that based on the relation between these environmental researches.

Keywords—Environmental planning, sustainable design, EIA and EMS.

I. INTRODUCTION

CONSTRUCTION as any other industry is an "organized economic activity concerned with manufacture, extraction and processing of raw materials, or construction" [1]. This definition addresses two terminologies; activities (processes) and output (products). Performance of any industry is evaluated based on specific set of criteria; cost, time, quality and environmental performance. These criteria evaluate the products based on their attributes and processes based on the objectives they can achieve.

Environmental performance as a criteria follow the same way to evaluate and control the environmental performance of construction industry. This explains one of differences between the previous four environmental research categories; sustainability is focusing on design attributes while EMS and environmental planning maintain construction processes and

practices.

Construction projects will be ready for execution when its client signs contracts with many parties; like designers, contractors, governments and so on.

Design team and construction system can be considered as the ones of high importance from technical point of view. This paper reviews some literature about how contract conditions, construction systems and design teams are managed to attain environmental requirement of the client. Also it proposes a framework to coordinate these managerial efforts done by DT and CS.

II. ENVIRONMENTAL IMPACTS ASSESSMENT

Building life cycle (BLC) is very important for studying its environmental impacts. BLC in general include five stages as represented in Fig. 1 [2].

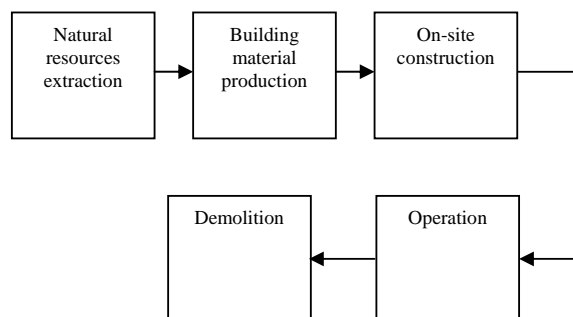

Fig. 1 BLC flow chart

There is a conflict in the information about the significance of environmental impact at each stage [3]. Thus most studies are trying to cover all of them in one model; for example the green building concept defined as "an environmentally sustainable building, which was designed, constructed and operated to minimize environmental impacts." [4].

Recent studies indicated that construction was ranked as third industry in USA based on generating Green House Emission GHG. Hence the environmental impacts of construction processes must be of great consideration [3].

Fig. 2 classified some of the methods used for assessing the environmental impacts EIA of construction processes.

Sami Mustafa M. E. Ahmed and Noor Amila Wan Abdullah Zawawi are with the Civil Engineering Department – Universiti Teknologi Petronas – Malaysia (e-mail: sami.utp@hotmail.com).

Zulkipli B. Ghazali is with the Management & Humanities Department–Universiti Teknologi Petronas - Malaysia.

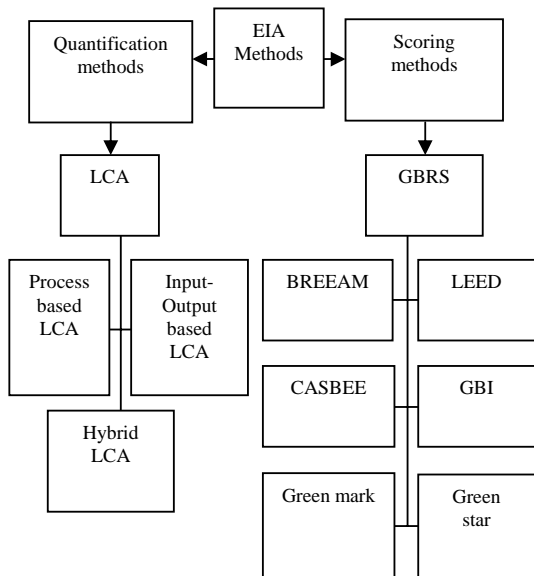

Fig. 2 EIA methods

III. INCLUSIONS OF ENVIRONMENTAL MANAGEMENT ELEMENTS IN CONTRACT DOCUMENTS

Importance of contract documents comes from the fact that, they are the exclusive governors which directing the relationship between constructions parties. They include contract form, general conditions, supplementary conditions, technical specification, drawings, addenda and change orders. One of the studies addresses that specifications preparation is the shortest way to insure inclusion of environmental elements in contract documents. It justifies that by saying "specifications define the materials and products to be used, the standard of work required, any performance requirements and conditions under which the work is to be executed" [5].

IV. ENVIRONMENTAL IMPACTS AND DESIGN

The importance role of design comes from the fact that environmental problems are global so they required global solutions, and design is one of them [6].

Green and sustainable design concepts are hot debatable issues over the world. Sustainable design taken signify the responsibility of the industry for the efficient use of natural resources, minimization of any negative impacts on environment as well as satisfaction of human needs and improvement of life quality [7].

Nazirah [8] believed that the future of sustainability in Malaysia is promising because of many reasons including:

- The trend is going towards sustainability,
- There is a gradual improvement among all industry parties about this concept,
- The arise of material costs would force these parties to seek more sustainable construction application,
- Various universities improve students awareness for sustainability issue, and
- Awareness among citizens is increasing.

Fahanim [9] quantifies criteria of sustainability based on case studies from Malaysia as in Fig. 3.

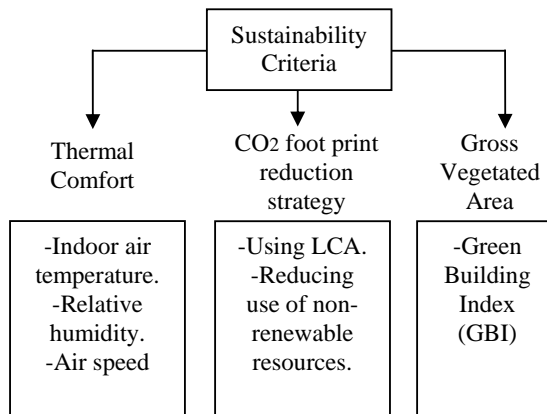

Fig. 3 Sustainability Criteria

The Conseil International du Batiment (CIB) postulated seven principles for sustainability; reducing resource consumption, reusing resources, using recyclable resources, protection nature, eliminating toxic, applying life cycle costing and emphasizing quality [7].

How to apply sustainability depends on it is drivers some studies focused on these drivers; energy conservation, waste reduction, indoor environmentally quality -Environmentally friendly energy technologies -Resources conservation - Incentive programs-Performance based on standards -land use regulations and urban planning polices -Education and training -Re-engineering the design process -sustainable construction materials -new cost metric based on economical and ecological value systems -New kinds of partnerships and project stakeholder -Product innovation and/or certification and recognition of commercial building as productivity assets [10].

Study from South Africa discuss the relation between sustainability and construction procurement system (CPS), it concludes that attaining sustainability construction is not possible due to inappropriate CPS there [11]. Sebake [12] achieved the same results when he discuss the limitations of applying sustainability into work plan stages in South Africa, Fig. 4 presents Sebake approach

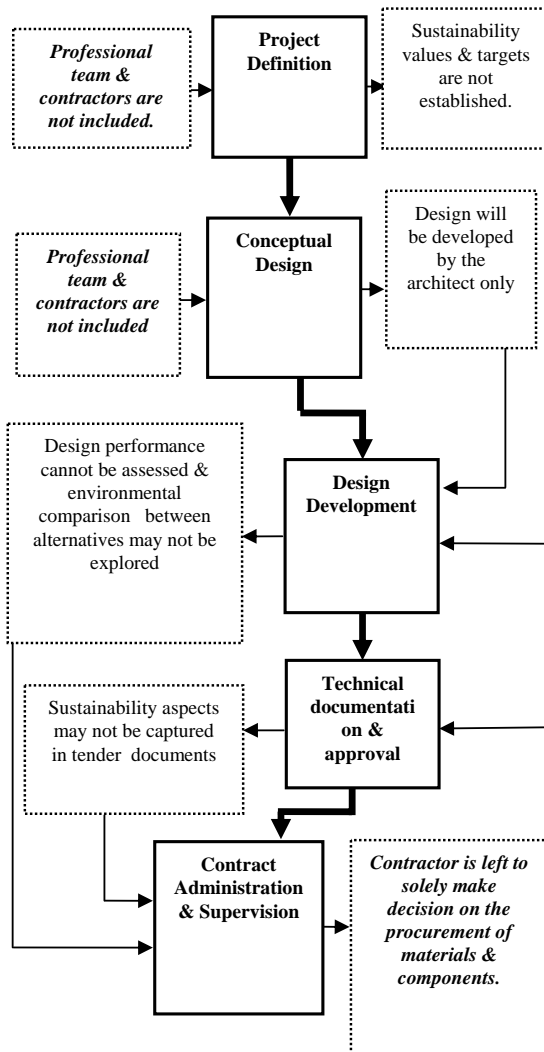

Fig. 4 Limitation of applying sustainability

Strategy of sustainable construction in UK based on ten drivers; the reuse of built assets, design for minimum waste, the aim of lean construction, minimizing energy in construction, minimizing energy in use, do not pollute, preserving and enhance biodiversity, conservation of water, the respect of people and their local environment and target setting [13].

Some studies promote value management as a mode towards enhancing sustainability integration at early stages. Nazirah [14] specified 7Cs which are necessary for this mode; clarification, commitment, cautious, conservation, condenses continuity and control.

Nazirah [8] mentioned many factors which impede active implementation of sustainability in Malaysia such as lack of knowledge, poor enforcement of legislation, education Vs experience and passive culture.

V. ENVIRONMENTAL MANAGEMENT SYSTEM (EMS)

The main role of construction systems is to make decisions which are required to execute the project according to design criteria.

System is composed of many sub-systems like Information Management System (IMS), Environmental Management System (EMS), Cost Management Systems (CMS) and Quality Management System (QMS).

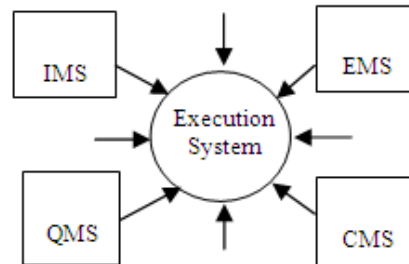

Fig. 5 Construction Sub-systems

For the purpose of this paper only EMS will be considered.

According to [15] there are six general characteristics required for any EMS;

- I. Goals, methods and timeline for meeting environmental requirements
- II. Documentation procedures relating to these goals
- III. Defined structure and responsibilities
- IV. Corrective and preventative actions
- V. An employee training plan
- VI. Periodic auditing plan

An EMS was developed using Delphi method in adaptive environmental management [13], when this EMS applied in Greece, results indicated that the competitive advantage in the future of sustainable construction is realized by the majority of the participants and the most important factor for it is assigned to efficiency/renewable energy issues and then conservation materials and techniques.

Study in Singapore [16] discussed the relation between ISO9000 QMS and ISO14001 EMS, it was found that there were similarity in some structural features; components, policies and objectives, training, monitoring and review, documentation, performance and specification. Some differences were recognized in five features; imputes motivation, target audience, focus, continual improvement and supplier involvement. This study found that some of disadvantages of QMS can be offset by integrating it with an EMS; implementation of integrated management system (IMS=QMS+EMS) assisting in improving both of QMS and EMS.

Zhen [17] proposed a qualitative approach to assess and control EI problems. To develop a method to calculate the Construction Pollution Index (CPI), the methods of preventing pollution and hazards are divided into four categories; technology, managerial, planning and building material.

Applying of this method in China showed that it is vital for major construction companies to obtain ISO14001 EMS certification because this will enable them to establish comprehensive environmental management policies within the context of construction management. Benefits of implementation of ISO14001 by firms in newly industrialized Malaysia are examined by Tan [18]; some of reason for seeking after certification and some of actual benefits gained are shown in Fig. 6.

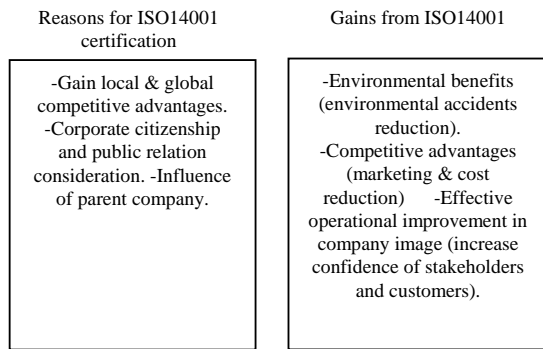

Fig. 6 Reasons and gains from ISO14001

Two other important studies based on Hong Kong construction companies, the first one [19] discussed the benefits and problems appear when applying ISO14001, and the other [20] focused on barriers. The results are shown in this Fig. 7.

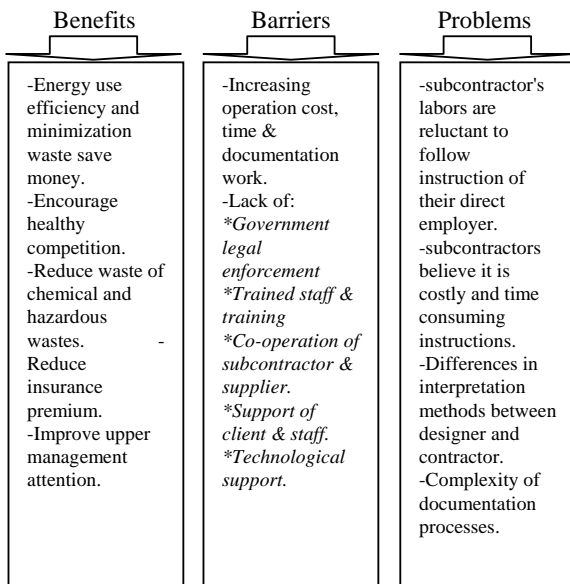

Fig. 7 ISO14001 Benefits, Barriers and Problems

VI. ENVIRONMENTAL PLANNING EP

The results of searching for papers which addressed environmental planning is just very few ones. But there are a lot of manuals and guidelines suggesting best practices. The importance strategic recommendations for improving environmental practices in construction industry are prepared by CIDB [21]; it looks like a guideline which considers five EP issues in Malaysia; strengthening the development approval process, enhancing law and enforcement, promoting self-regulation, increasing capacity and public awareness and addressing knowledge gaps.

VII. CONCLUSIONS

First thing recognized from this review is that all these studies are based on either case studies or questionnaire survey; fragmented partial efforts done in different construction industries. The differences between these industries may make the results valid only where they have been conducted. Another recognized notice is that these researches fragmented also on their aims; each of them has specific function on the overall PEM; depending on only EMS may not solve the problem because there are many other function required like design criteria and/or contract clauses. So there is a need to develop a theoretical PEM developing a framework which is driven from the previous literature like this one suggested below; Fig. 8.

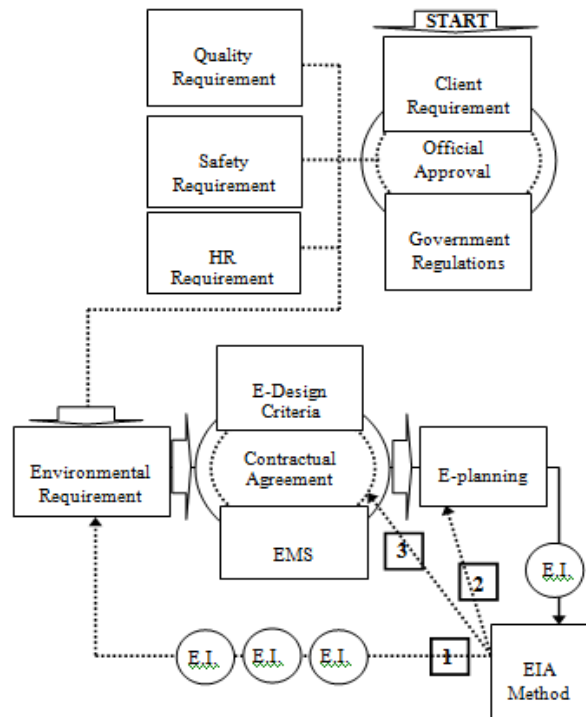

Fig. 8 Theoretical framework for managing environmental impacts of construction project based on literature review

This framework is illustrated by the following steps:

1. Design which meets client requirements is selected.
2. The feasibility of design is defined by determining initial characteristics of the project in terms of money, time and equivalent Kg of CO₂.
3. Bidding process is proceeded based on the capabilities of the construction system (designer + contractor) which can execute the design in such way that achieve its initial requirements.
4. These requirements must be included in the contractual agreement, mainly in specifications.
5. Project plans; plans of cost, time, quality, environmental plan and so on, will be established according to the previous contractual agreement.
6. The presence of the environmental impacts; EIs is inevitable. Assessment of these EIs can be done by one of the EIA methods shown in this study. Results of this assessment process are compared with the initial values in step 2.
7. According to these comparisons there is at least one of the following decisions has to be taken:
 - Results are matching the initial values then it might be accepted.
 - These are minor differences which may be maintained by do some re-planning efforts.
 - The differences are so big and there will be a need to revise the contract agreement. The revision will lead either to re-design, re-engineering or both of them.
8. These processes will be continued until optimum design, system and plan are achieved.

REFERENCES

- [1] <http://encyclopedia2.thefreedictionary.com/industry>
- [2] Wang, W. (2005). "A simulation-based system for green building design". PhD thesis, Concordia University, Canada.
- [3] Deniz, G.O., Zhu, Y. and Ceron, V. (2011) "Time, cost, and environmental impact analysis on construction operation optimization using genetic algorithms". *J. Mgt in Eng.*
- [4] Rahardjati, R. (2011). "Criteria weighting of green building index Malaysia". M.Sc. thesis, Universiti Teknologi PETRONAS, Malaysia.
- [5] Asyirah A.R. (2007). "A study on the potential inclusion of environmental elements in contract documents of construction projects in Malaysia." PhD thesis, Universiti Sains Malaysia.
- [6] Said, I., Rashideh, W. M., Osman, O. and Abd. Razak, A. (2009). "Modeling of construction firms sustainability" , 3rd International Conference on Construction Industry, Indonesia.
- [7] Alyami, A.M. and A.D.F. price. (2006). "A framework for implementing sustainable construction in building briefing project." 22nd Annual ARCOM conference, UK, 327-337.
- [8] Zainul Abidin, N. (2009). "Sustainable construction in Malaysia developers' awareness." *J. World Academy of Science, Engineering and Technology*, 41, pp.807-814.
- [9] Abdul Rashid, F., Ismail, M.A. and Prasad, D. (2011). "Quantifying the sustainable building criteria based on case studies from Malaysia". *J. World Academy of Science, Engineering and Technology*, 78, pp. 267-271.
- [10] Manoliadis, O.; Tsolas, I.; Nakou, A. (2006) "Sustainable construction and drivers of change in Greece: a Delphi study". *J. Constr. Mgt & Econo.*, 24(2), pp. 113-120.
- [11] Rwelamila, P.D. (2000). "Attainment of a sustainable built environment- is it possible under 'Barefoot Empiricism' in project procurement?". Conference of Strategies for a sustainable built environment, South Africa.
- [12] Sebake, TN. (2008). "Limitation of implementing sustainable construction principles in the conventional South Africa design approach" The third Built Environment conference, South Africa.
- [13] Manoliadis, O. (2008). "The Role of Adaptive Environmental Management in Sustainable Development Case Study Assessing the Economical Benefits of Sustainable Construction in Greece" *Environmental technologies: new developments*, chapter 6 pp. 85-96.
- [14] Zainul Abidin, N. and Said, A. (2006). "Involvement of sustainability issues in value management: request factors". 2nd International Conference on Construction Industry, Pakistan.
- [15] Christini, G., Fetsko, M. and Hendrickson, C. (2004). "Environmental Management Systems and ISO 14001 certification for construction firms," *J. constr. eng. and mgt.* 130,3, pp.330-336.
- [16] Ofori, G., Gang, G., Briffet, C. (2002). "Implementing environmental management systems in construction: lessons from quality systems". *J. Build and environment*, 37, pp. 1397-1407.
- [17] Chen, Z., Li, H. and Wong, C.T.C. (2000). "Environmental management of urban construction projects in China". *J. Constr. Eng. And Mgt*, 126(4), pp. 320-324.
- [18] Tan, P.L. (2005). "Implementing ISO14001: is it beneficial for firms in new industrialized Malaysia?". *J. Cleaner Production*, 13 pp.397-404.
- [19] Raymond, Y.C., (2001). "The implementation of EMS in construction firms: case study in Hong Kong". *J. Environmental assessment policy and management*, 3(2), pp.177-194.
- [20] Shen, L.Y. and Tam, V.W.Y. (2002). "Implementation of environmental management in the Hong Kong construction industry" *Inter. J. Proj. Mgt.*, 20 pp. 535-543.
- [21] CIDB (2007). "Strategic Recommendations for improving environmental practices in construction industry."