

Analysis of Fixed Beamforming Algorithms for Smart Antenna Systems

Muhammad Umair Shahid, Abdul Rehman, Mudassir Mukhtar, Muhammad Nauman

Abstract—The smart antenna is the prominent technology that has become known in recent years to meet the growing demands of wireless communications. In an overcrowded atmosphere, its application is growing gradually. A methodical evaluation of the performance of Fixed Beamforming algorithms for smart antennas such as Multiple Sidelobe Canceller (MSC), Maximum Signal-to-interference ratio (MSIR) and minimum variance (MVDR) has been comprehensively presented in this paper. Simulation results show that beamforming is helpful in providing optimized response towards desired directions. MVDR beamformer provides the most optimal solution.

Keywords—Fixed weight beamforming, array pattern, signal to interference ratio, power efficiency, element spacing, array elements, optimum weight vector.

I. INTRODUCTION

WITH the dawn of new wireless technologies, the atmosphere is getting packed with electromagnetic noise and interfering sources. The number of interfering sources is mounting, and it is becoming critical to precisely trace the signals of interest and simultaneously discard the signals not of interest. The rapid increase in usage of smart phones and other wireless devices is demanding superior battery life, high efficiency, enhanced capacity, improved service quality, and increased the coverage area. Smart antennas are best suited to achieve these objectives, which effectively communicate between source and receiver in an ever altering surrounding. They have the ability of spatial filtering to receive energy from a specific direction while at the same time rejecting it from another direction.

Smart antennas testify their environment and based on the source position, adjust their antenna pattern to locate user accurately and then give optimized gain in that direction. The source location is found via various Direction of Arrival algorithms. Based on that information, the next job of a smart antenna system is to focus the electromagnetic radiation of array elements in the desired direction which is called Beamforming. The beam formed is required to focus on the signals of interests only and should have nulls in the direction of interferers [7]. System performance is determined by array weights. Various techniques are used to accomplish this goal. Every method has its pros and cons depending on various factors which are analyzed in this paper. Beamforming is of two types:

- 1) Fixed Weight Beamforming
- 2) Adaptive Beamforming

Muhammad Umair Shahid is with the Bahria University, Pakistan (e-mail: umair.shahid@bui.edu.pk).

In Fixed Weight Beamforming, multiple fixed beams in predetermined directions are used to serve the users. In this approach, the base station switches between several beams that give the best performance as the mobile user moves across the cell. In Adaptive Beamforming, the beam pattern is updated in real time depending on the data from antenna arrays using adaptive algorithms.

This paper is organized as follows; Section II provides mathematical modeling of antenna arrays for optimum beamforming solution. Section III briefly narrates Fixed Weight Beamforming algorithms and their optimal criteria for array weights. Section IV explains the simulations. Section V is the core of paper which discusses the results for different cases. Section VI concludes the paper.

II. BEAM FORMER DESIGN METHODS

Antenna array processing plays a vital role in deploying signals, steering nulls to the interferers and forming beams in the desired direction. With the estimation of direction of the sources (DOA), the next is to steer antenna beam pattern. For better performance at the receiver end, it is important to improve spatially processing techniques because the received signals can contain intended source, noisy components, and co-channel interference. Before discussing beam forming algorithms, formulations are being made to simplify our simulations and results.

A. Methods and Material

The functional diagram of Smart Antenna system as illustrated in Fig. 1 shows one desired signal and N interferers (i-e from $\theta_1 \dots \theta_N$ phases) impinging on M array elements having M potential weights [1], [7]. Thus, array factor can be represented as;

$$y(k) = \bar{w}^H \cdot \bar{x}(k) \quad (1)$$

$$\bar{x}(k) = \bar{a}_0 s(k) + [\bar{a}_1 \bar{a}_2 \dots \bar{a}_N] \cdot [i_1(k) i_2(k) \dots i_N(k)]^T + \bar{n}(k) \quad (2)$$

$$\bar{x}(k) = \bar{x}_s(k) + \bar{x}_1(k) + \bar{n}(k) \quad (3)$$

The overall output of the beam former system can be written as;

$$y(k) = \bar{w}^H \cdot [\bar{x}_s(k) + \bar{x}_1(k) + \bar{n}(k)] \quad (4)$$

$$= \bar{w}^H \cdot [\bar{x}_s(k) + \bar{u}(k)]$$

$\bar{u}(k)$ be the undesired signal. For steering nulls for the interferers, the array output must follow the following constraints;

Condition 1: For desired signals, weights multiplied with the steering vectors of array elements is equal to 1. In the other words, maximum gain is achieved.

$$y(k) = \bar{w}^H \cdot \bar{A}_d = \bar{u}_1^T = 1 \text{ (For Desired user)} \quad (5)$$

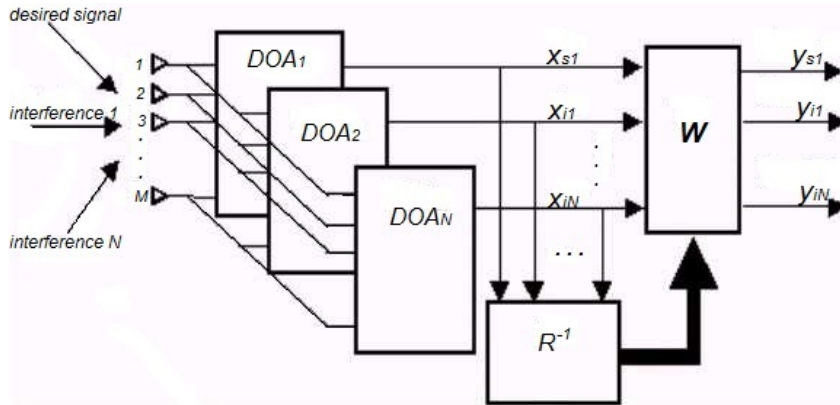

Fig. 1 Block diagram of Smart Antenna System

Condition 2:

$$y(k) = \bar{w}^H \cdot \bar{A}_1 = 0 \text{ (For interferers)} \quad (6)$$

Therefore, using condition (1) weights can be executed by;

$$\bar{w}^H = \bar{u}_1^T \cdot \bar{A}_d^{-1} \quad (7)$$

where $\bar{u}_1^T = [1 \ 0 \ 0]^T$ is the Cartesian basis vector and indicates that the array weights are taken from the 1st row of \bar{A}_d^{-1} . $\bar{A}_d = [\bar{a}(\theta_1), \bar{a}(\theta_2), \dots, \bar{a}(\theta_N)]$ is the array response vector of each antenna elements. It must be a $N \times N$ matrix. \bar{A}_1 is the interferers steering vector.

B. Smart Antenna System

According to Fig. 1, it mainly includes three parts.

- The first part estimates the angle of arrival (AOA) and finds out number of signals impinging on antenna arrays.
- The second part distinguishes between the signals from the desired source and the interferers. It contains DOA algorithms.
- The last part implements beam forming algorithm. Its purpose is to lessen the effect of unwanted signals and to steer a beam pattern in the desired direction of the user.

C. Assumptions Made

Prior to advance and modeling antenna arrays, in this paper, we throughout assumed the following [1]-[3], [5];

- The array elements are spaced $\lambda/2$, respectively.
- There is one signal of interest (SOI) and others as interferers.
- Number of arriving signals to be less or equal to number of array elements.
- The signals striking the array elements are considered to be narrowband and all operate at same carrier frequency.
- Received signal contains noise which is additive white Gaussian noise having zero mean.

- For simplicity, time dependence is suppressed during equation formulation because the arrival angles do not change for fixed emitters.

III. FIXED WEIGHT BEAM FORMING

Fixed beam forming yields considerable gains in communication system performance. In this statistically optimum beam forming technique, the weights are fixed when multiplied with signals at each antenna elements. It can also be termed as data-independent scheme. The weights are designed so that the beam former response approximates a desired response independent of data statistics [3]. Fixed weight beam former algorithms compared in this paper are:

- MSC
- MSIR
- MVDR

A. MSC

The basic side lobe cancellation scheme works through an intuitive application of the array steering vector for the desired signal and the interfering signals [1]. Weights are selected so as to maximize the output power. It plays an important role in environments where desired signals are weak than interferes. Using (5)-(7) and by Godara [2], [3] method.

$$\bar{w}^H = \bar{u}_1^T \cdot \bar{A}_d^H (\bar{A}_d \cdot \bar{A}_d^H + \sigma_n^2 \bar{I})^{-1} \quad (8)$$

\bar{u}_1^T is Cartesian basis vector and its length equals the number of sources used.

B. MSIR

The proposed optimization technique is concerned with maximizing the SIR of the received signal. This is achieved by choosing such weights that directly maximize the SNR [3]-[5]. Its purpose is to mitigate the effect of interferers, placing nulls at their corresponding arrival angles. Assuming ergodicity, we can calculate the array correlation matrices [1], [6]. The

weighted average power for the desired signal is provided as;

$$\bar{R}_{uu} = \bar{R}_{ii} + \bar{R}_{nn} \quad (12)$$

$$\sigma_s^2 = E [|\bar{w}^H \cdot \bar{x}|^2] = \bar{w}^H \cdot \bar{R}_{ss} \cdot \bar{w} \quad (9)$$

where,

$$\bar{R}_{ss} = E [\bar{x}_s \cdot \bar{x}_s^H] \quad (10)$$

Similarly, for undesired signal, we have;

$$\sigma_u^2 = E [|\bar{w}^H \cdot \bar{x}|^2] = \bar{w}^H \cdot \bar{R}_{uu} \cdot \bar{w} \quad (11)$$

\bar{R}_{ii} = Correlation matrix for interferers, \bar{R}_{nn} = Correlation matrix for noise.

Using (7), we can calculate w_{opt} and using this weight vector, w_{SIR} is concluded.

The optimal weights criteria, constraint equation and eigenvector-based Wiener solution for maximum SIR is provided in Fig. 2.

Criteria	Method	Equation	Solution
Maximum SIR	$SIR = \frac{\sigma_s^2}{\sigma_u^2} = \frac{\bar{w}^H \cdot \bar{w} \cdot \bar{R}_{ss}}{\bar{w}^H \cdot \bar{w} \cdot \bar{R}_{uu}}$	$\bar{R}_{uu}^{-1} \cdot \bar{w}_{SIR} \cdot \bar{R}_{ss} = \lambda_{max} \cdot \bar{w}_{opt}$	$\bar{w}_{SIR} = \beta \cdot \bar{R}_{uu}^{-1} \cdot \bar{a}_0$ $\beta = \frac{E[s ^2]}{SIR_{max}} \cdot \bar{a}_0^H \cdot \bar{w}_{SIR}$

Fig. 2 MSIR Criteria for Optimal Weights

C. MVDR Distortionless Response

The basic idea of the MVDR method is to impose a constraint on the response of beamformer to permit SOI passed with specified gain and phase [3]. The weights are selected to minimize output variance so that contribution to output from interfering signals and noise other than direction of SOI is minimized [4], [6]. It is assumed that desired and unwanted signals have zero mean.

Referring to (5) and (6) as discussed before, the two constraint equations

$$y(k) = \bar{w}^H \cdot \bar{A}_d = \bar{u}_1^T = 1 \quad (\text{For Desired user}) \quad (13)$$

$$y(k) = \bar{w}^H \cdot \bar{A}_i = 0 \quad (\text{For interferers}) \quad (14)$$

must be satisfied to ensure distortionless response.

From (4), the weighted array output is given as;

$$y = \bar{w}^H \cdot [\bar{a}_0 s + \bar{u}]$$

Applying the constraint (5) to above, we have

$$y = s + \bar{w}^H \bar{u} \quad (15)$$

As assumed, the unwanted signals have average mean of zero, so expected array output becomes;

$$E[y] = s \quad (16)$$

The variance of y is calculated as;

$$\sigma_{MV}^2 = E [|\bar{w}^H \bar{x}|^2] = E [|s + \bar{w}^H \bar{u}|^2] = \bar{w}^H \bar{R}_{uu} \bar{w} \quad (17)$$

So, the criterion, constraint equation (cost function or performance surface), and optimum weights are deduced in Fig. 3.

Criteria	Method	Equation	Solution
Minimum Variance	$Var(y) = \bar{w}^H \cdot \bar{R}_{xx} \cdot \bar{w} + \bar{w}^H \bar{R}_{uu} \bar{w}$	$J(\bar{w}) = \frac{\sigma_{MV}^2}{2} + \lambda(1 - \bar{w}^H \bar{a}_0)$ $\nabla_{\bar{w}} J(\bar{w}) = \bar{R}_{uu} \bar{w}_{MV} - \lambda \bar{a}_0 = 0$	$\bar{w}_{MV} = \lambda \bar{R}_{xx}^{-1} \bar{a}_0$ $\lambda = \frac{1}{\bar{a}_0^H \bar{R}_{uu}^{-1} \bar{a}_0}$

Fig. 3 MVDR Criteria for optimal weights

IV. SIMULATION

Non-adaptive beamforming algorithms are simulated using M elements uniformly spaced arrays. For this purpose, MATLAB provides the simulation environment. We have considered two real time cases.

CASE I. Table I shows conditions taken for case I.

CASE II. Table II shows conditions taken for case II.

In fixed weight beam forming, the factor of time is suppressed because emitters are not moving, therefore during the generation of results time factor is neglected. While simulating the stated algorithms, certain assumptions were made as described in Section II, and signal properties were

exploited. In this paper, the parameters undergo changes in array elements, Interferer angles and spacing between the elements. Simulations are made for both case I and case II and include totally four plots.

TABLE I
ARRAY ELEMENTS VERSUS INTERFERENCE SIGNALS

ARRAY ELEMENTS	INTERFERENCE ANGLES
Array elements = 5 and 10	Array elements = 5
Interferer angles = -50° and 60°	Interferer angles(2) = -50° and 60°
	Interferer angles(3) = -40°, 20° and 80°
Array distance = $\lambda / 2$	Array distance = $\lambda / 2$
Noise variance = 0.001	Noise variance = 0.001
Desired signal angle = 0°	Desired signal angle = 0°

TABLE II
ARRAY ELEMENTS VERSUS ELEMENT SPACING

ARRAY ELEMENTS	ELEMENT SPACING
Array elements = 5 and 10	Array Elements = 5
Interferer angles = -50° and 60°	Interferer angles = -50° and 60°
Array distance = $\lambda/4$	Array Distance(1) = $\lambda/4$
	Array Distance(2) = $\lambda/2$
Noise variance = 0.001	Noise Variance = 0.001
Desired signal = 0°	Desired signal = 0°

- Plot with increasing array elements to that of interferer signals at -50° and 60° , while all other parameters are kept constant.
- Plot with increasing interferer signals impinging at -50° and 60° and then at -40° , 20° , and 80° to that of array elements, while keeping the other parameters constant.
- Plot with increasing array elements and elements spacing changed to $\lambda/4$, whereas noise variance and interfering signals are kept constant.
- Plot with elements spacing i-e at $\lambda/4$ and $\lambda/2$ by taking array elements $M = 5$, whereas noise variance and interfering signals are kept constant.

V. RESULTS

Considering above two cases, the normalized weights for each beamformer algorithm are calculated, and resulting beam pattern is plotted.

A. Multiple MSC

CASE I. Fig. 4 (a) depicts that desired signal is coming from 0° and interference signals are at -50° and 60° . In both plots with $M = 5$ and 10 array elements, the main beam is directed towards the desired signal and it also nullifies interference signals at corresponding angles with some margin of error. With 10 elements, beam is narrower towards the signal of interest. Side lobes have increased as compared to previous but low in amplitude. So decreasing array elements the percentage side lobe cancellation increases but it also reduces the contribution of desired signal. Narrower beam shows more output power.

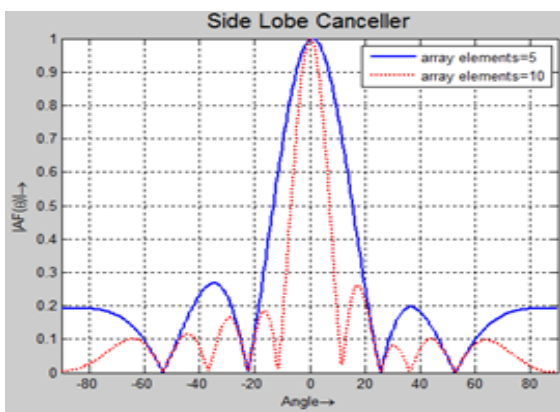

Fig. 4 (a) MSC array element variation

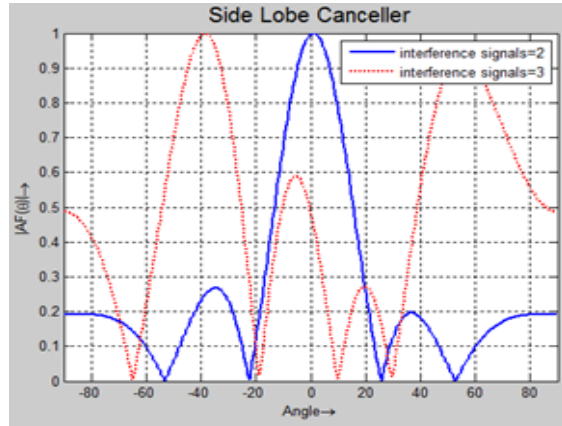

Fig. 4 (b) MSC interferer variation

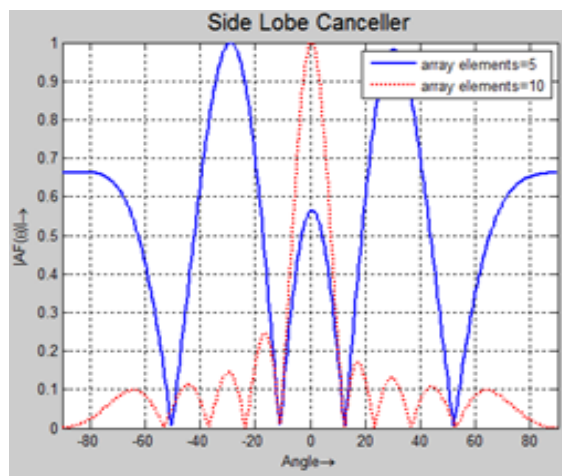

Fig. 4 (c) MSC array element variation

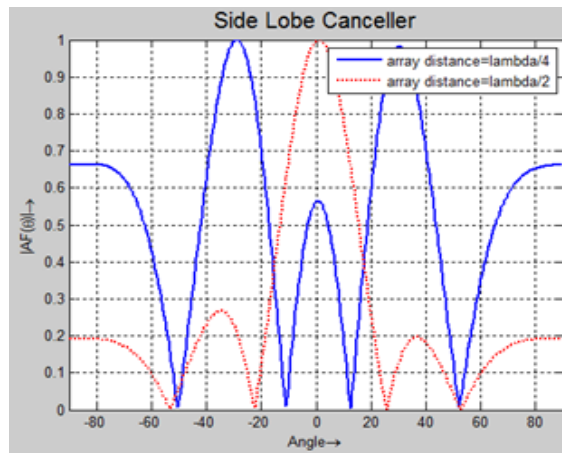

Fig. 4 (d) MSC array distance variation

In Fig. 4 (b), the array elements are kept constant, i.e. $M = 5$. Now take interference angles to -40° , 20° , and 80° . The solid line plot is of array having interference signals at -50° and 60° . The dotted graph is showing an array with interference signals at -40° , 20° , and 80° . It is not nullifying the interference

signals and also not directed towards signal of interest. So, when we increase interference signals, the Side Lobe Canceller fails to deliver desired results.

CASE II: Parameter of interest in this case is element spacing. In Fig. 4 (c) desired signal is coming at angle of 0° and interference signals at -50° and 60° . We take $M = 5$ and 10 elements array but spacing between elements is now changed to $\lambda/4$ instead of $\lambda/2$. In Fig. 4 (d), the array elements are kept constant $M = 5$, while desired signal at 0° and interference signals at -50° and 60° .

The figures represent, as the element spacing is reduced then because of mutual coupling the maximum and nulls of the radiation pattern began to shift, hence providing distorted response. For reduced element spacing, the cost comes at increasing array elements so that desired results are more likely to be achieved. For better results, spacing between the elements should be increased.

V. MAXIMUM SIGNAL - TO - INTERFERER

CASE I: Fig. 5 shows: (a) the plot of weighted MSIR array versus angle of arrival of desired source and interferers (b) the plot of weighted MSIR array versus arrival of sources but with three interferers.

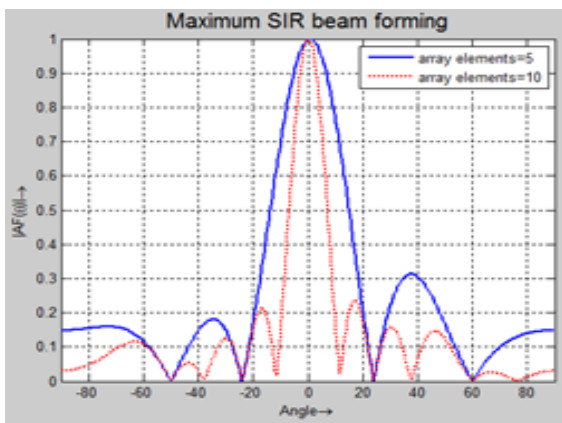

Fig. 5 (a) MSIR array element variation

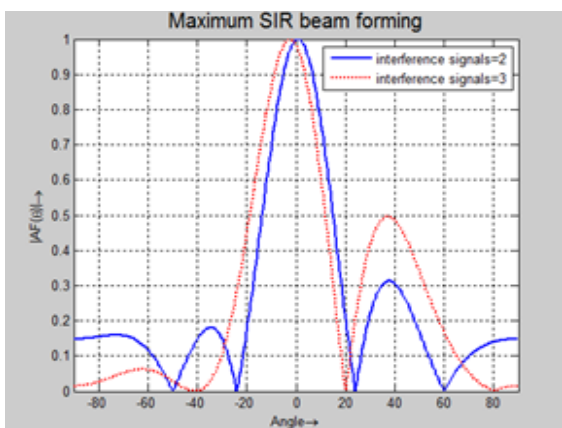

Fig. 5 (b) MSIR array interferer variation

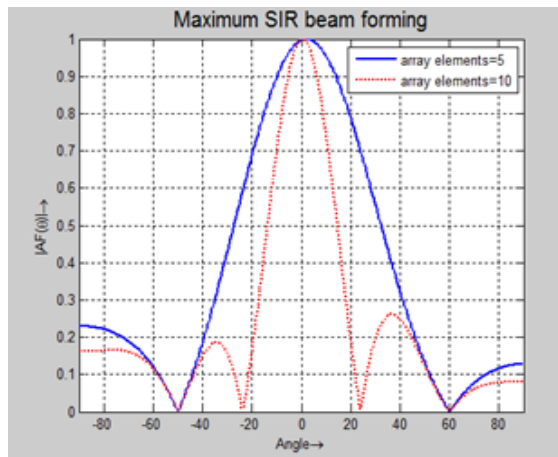

Fig. 5 (c) MSIR array element variation

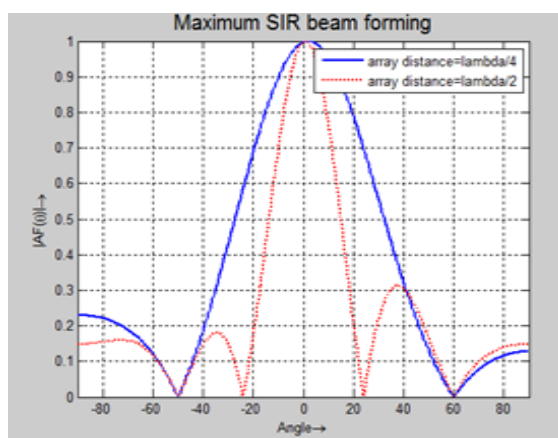

Fig. 5 (d) MSIR array distance variation

In Fig. 5 (a), the desired signal is coming from of 0° and interference signals are coming at angle of -50° and 60° . In Fig. 5 (b), the array elements are taken to be $M = 5$, but only parameter to change is the interfering signals AOA (-40° , 20° , and 80°). In Fig. 5 (a), the result shows array elements with $M = 5$ and $M = 10$, the main beam is well steered towards the desired signal hence maximizing SNR. Interference signals are also knocked down with minimal errors. In the dotted radiation pattern, it is more power efficient as compared to previous result. So, clearly increase in array elements, SIR increases. In Fig. 5 (b), with less interferers, the result is same with $M = 5$ elements but interference signals distort the main beam when interferers are increased.

CASE II: Fig. 5 (c) shows the plot of weighted MSIR array versus $\lambda/4$ element spacing (d) the plot of weighted MSIR array with $\lambda/2$ and $\lambda/4$ element spacing.

In Fig. 5 (c), the desired signal is coming at angle of 0° and interference signal is coming at angle of -50° and 60° . First, for array elements of $M = 5$ and 10 elements, spacing is kept $\lambda/4$. But, in Fig. 5 (d), element spacing is $\lambda/2$ and $\lambda/4$, while elements are $M = 5$. Wider width of the radiation pattern with $M = 5$ shows that weights are selected in such a way that these are minimizing the output power and also performing

cancellation of the desired signal. In dotted graph with $M = 10$ elements, the main beam is much narrower towards the signal of interest, but side lobes are increased as compared to previous case. Similarly, it is also nullifying interference at -50° and 60° . So, when we will increase array elements spacing, SIR increases.

VI. MVDR

CASE I: Fig. 6 (a) shows the plot for weighted MVDR arrays versus angle of arrival of desired source and two interferers. Fig. 6 (b) shows the plot for weighted MVDR arrays versus angle of arrival of desired source three interferers.

In Fig. 6 (a) desired signal is coming at angle of 0° , and interference signals are coming at angle of -50° and 60° . For $M = 5$ and 10 array elements, the patterns are similar as compared with MSC, MSIR, and MMSE for Case I and represents that when array elements increase the pattern become more power efficient than with $M = 5$ elements. Similarly, it is also nullifying interference at -50° and 60° . The side lobes increase but have low amplitude. In Fig. 5 (b), now the interference signals are at $[-40^\circ, 20^\circ$ and $80^\circ]$ with $M = 5$ array elements showing that it will distort the desired pattern towards desired signal because of contributions from interferers.

CASE II: Fig. 6 (c) shows the plot for weighted MVDR arrays versus $\lambda/4$ element spacing Fig. 6 (d) shows the plot for weighted MVDR arrays versus $\lambda/4$ and $\lambda/2$ element spacing.

In Fig. 6 (c), the desired signal is coming at angle of 0° , and the interference signals are coming at angle of -50° and 60° . First, for $M = 5$ and 10 array elements with elements, spacing of $\lambda/4$ pattern is plotted. Whereas, in Fig. 6 (d) for $M = 5$ with element spacing of $\lambda/4$ and $\lambda/2$ pattern is plotted. The results are similar as compared with previous methods. So, array distance must be enough to avoid mutual coupling between the elements and to maintain efficient power towards the desired user.

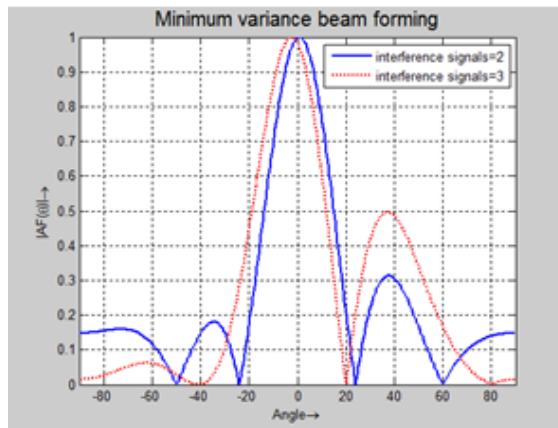

Fig. 6 (b) MVDR interferer variation

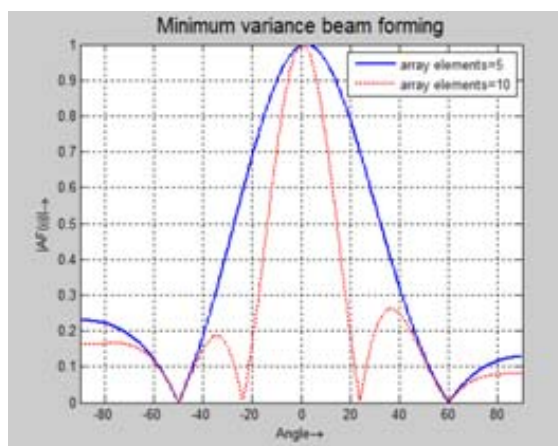

Fig. 6 (c) MVDR array element variation

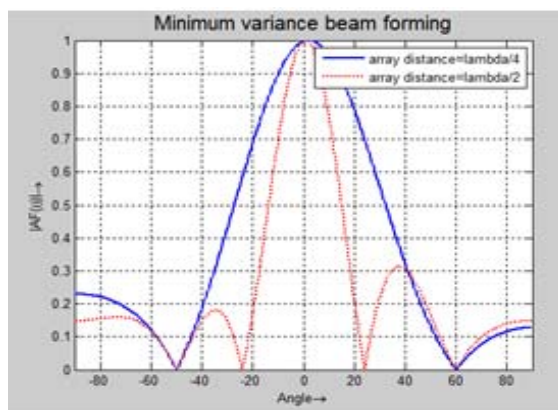

Fig. 6 (d) MVDR array distance variation

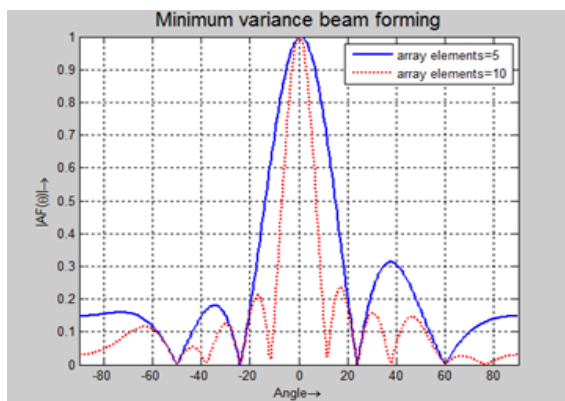

Fig. 6 (a) MVDR array element variation

VI. CONCLUSION

This paper deliberates beamforming techniques which gained remarkable significance in communication system due to its ability to increase capacity and to reduce interference. Simulation results show the null steering and array pattern analysis of different fixed weight beam forming algorithms. In

MSC, the desired signal which may be strong enough still can contribute in signal cancellation instead of side lobe cancellation. MSIR requires estimate of signal and noise covariance matrix so that largest eigenvalue can be selected for maximum SIR. Lack of information about desired signal is of more concern than direction in MMSE method. It is better than MV in terms of mitigating the multipath arrivals. ML beamformer resembles with MVDR solution. But, MV beamformer includes interference signals as well as noise. It minimizes average power and maintains unity gain in the desired look direction. Thus, MVDR provides more general application beamformer.

REFERENCES

- [1] "Smart Antennas for Wireless Communications", Frank Gross with MATLAB by McGraw-Hill Companies Inc. 2006.
- [2] "Application of antenna arrays to mobile communications, part II: Beamforming and direction-of-arrival considerations", Godara L., Proc. IEEE, vol. 85, No. 8 Aug, 1997.
- [3] "Beamformer: A versatile approach to spatial filtering", Barry D. Van Veen and Kevin M. Buckley, IEEE ASSP magazine April 1988.
- [4] "Performance analysis of Beamforming Algorithms", Reeta Gaokar and Dr. Alice Cheeran IJECT Vol. 2 Issue I, March 2011.
- [5] "Robust Algorithms for DOA estimation and Adaptive beamforming for Smart Antenna application", Suchita W. Varade, K. D. Kulat, ICETET, 2009.
- [6] Dahrouj H., Yu W., "Coordinated Beamforming for the Multicell Multi-Antenna Wireless System". IEEE transactions on wireless communications, vol. 9, no. 5, May 2010.
- [7] "Antenna Theory analysis and design", Constantine A. Balanis, John Wiley & Sons, Inc. 3rd edition, 2005.