

# Stabilization of Rotational Motion of Spacecrafts Using Quantized Two Torque Inputs Based on Random Dither

Yusuke Kuramitsu, Tomoaki Hashimoto, Hirokazu Tahara

**Abstract**—The control problem of underactuated spacecrafts has attracted a considerable amount of interest. The control method for a spacecraft equipped with less than three control torques is useful when one of the three control torques had failed. On the other hand, the quantized control of systems is one of the important research topics in recent years. The random dither quantization method that transforms a given continuous signal to a discrete signal by adding artificial random noise to the continuous signal before quantization has also attracted a considerable amount of interest. The objective of this study is to develop the control method based on random dither quantization method for stabilizing the rotational motion of a rigid spacecraft with two control inputs. In this paper, the effectiveness of random dither quantization control method for the stabilization of rotational motion of spacecrafts with two torque inputs is verified by numerical simulations.

**Keywords**—Spacecraft control, quantized control, nonlinear control, random dither method.

## I. INTRODUCTION

THE first theoretical investigation of the equations of the rotational motion of a rigid body is due to the paper [1], where the necessary and sufficient conditions have been provided for the controllability of a rigid body in the case of one, two and three independent control torques. This paper sparked a renewed interest in the area of control of rigid spacecraft equipped with less than three control torques. Fig. 1 shows the case when one of the nominal three thruster jets had failed. In [2], it was shown that the angular velocity equations can be made asymptotically stable about the origin by means of two torques, each applied along a principal axis. The problem of state feedback stabilization of the angular velocity of a rigid body with two control torques was studied and solved using various approaches. The design method proposed in [3] relies on the center manifold theory, whereas the solution in [4] makes use of control Lyapunov functions and La Salle invariance principle. Exponential stabilization is achieved by homogeneous feedback proposed in [5]. The attitude equations were addressed in [6]. It was proved in [6] that there is no smooth state variable feedback law that locally asymptotically stabilizes a rigid spacecraft about a desired reference attitude

This work was supported in part by Japan Society for the Promotion of Science, Grant-in-Aid for Scientific Research (C), Grant Number JP18K04216.

Y. Kuramitsu and H. Tahara are with the Department of Mechanical Engineering, Osaka Institute of Technology, Asahi-ku 535-8585, Japan.

T. Hashimoto is with the Department of Mechanical Engineering, Osaka Institute of Technology, Asahi-ku 535-8585, Japan (e-mail: tomoaki.hashimoto@oit.ac.jp).

with two control torques. Time-varying control methods were proposed in [7], [8] for the attitude stabilization with two control torques to circumvent the topological obstruction to smooth stabilizability due to Brockett's necessary condition [2].

The thruster jets known as discrete-level actuators are often used for the attitude control of spacecrafts. Then, the control inputs with thruster jets are considered as quantized control inputs. The stabilization problem of rotational motion of spacecrafts using quantized control is one of the interesting research topics.

Recently, the so-called random dither quantization that transforms a given continuous signal to a discrete signal by adding artificial random noise to the continuous signal before the quantization has attracted much amount of interest. Model predictive control [9]-[11], also called as receding horizon control [12]-[17], is a type of optimal feedback control and the stochastic model predictive control [18]-[21] has been applied to the quantized control of systems with random dither quantizer in [22].

Motivated by the fact that the actuators such as thruster jets that are used for the attitude control of spacecrafts yield discrete-level inputs, the random dither quantization method was applied in [23] to the nonlinear feedback control for the attitude stabilization of spacecraft using three control torque inputs. However, the design problem of quantized control systems for the stabilization of rotational motion of spacecrafts using two control torque inputs has not yet been studied. Therefore, the objective of this study is to propose a control method based on the random dither quantization method for the stabilization of rotational motion of spacecrafts using two control torque inputs. The effectiveness of the proposed method is verified by numerical simulations.

This paper is organized as follows. In Section II, we introduce some notations and the system model of a spacecraft. In Section III, we consider the control design problem of spacecraft attitude with quantized control inputs. The main results are provided in Section IV. Finally, some concluding remarks are given in Section V.

## II. NOTATIONS AND SYSTEM MODEL

First, we introduce the system model of a spacecraft with two control torque inputs. Let us consider a rigid spacecraft in an inertial reference frame and let  $\omega_1(t)$ ,  $\omega_2(t)$ , and  $\omega_3(t)$  denote the angular velocity components along a body fixed

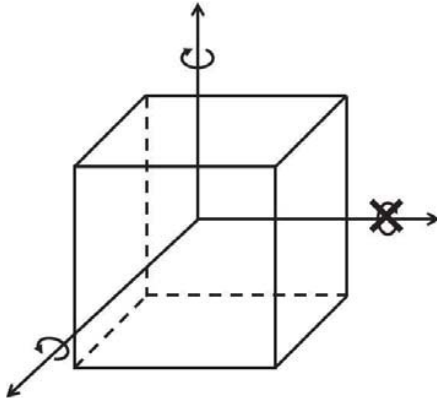

Fig. 1 A schematic view of underactuated spacecrafts

reference frame having the origin at the center of gravity and consisting of three principal axes. The Euler's equations for the rigid body with two independent controls aligned with two principal axes are

$$J_1 \dot{\omega}_1(t) = (J_2 - J_3)\omega_2(t)\omega_3(t) + u_1(t) \quad (1a)$$

$$J_2 \dot{\omega}_2(t) = (J_3 - J_1)\omega_3(t)\omega_1(t) + u_2(t) \quad (1b)$$

$$J_3 \dot{\omega}_3(t) = (J_1 - J_2)\omega_1(t)\omega_2(t) \quad (1c)$$

where  $J_1 > 0$ ,  $J_2 > 0$ , and  $J_3 > 0$  denote the principal moments of inertia and  $u_1(t)$  and  $u_2(t)$  denote the control torques. Let us introduce the inertia ratios  $I_1$ ,  $I_2$ ,  $I_3$  defined as follows:

$$I_1 = \frac{J_2 - J_3}{J_1}$$

$$I_2 = \frac{J_3 - J_1}{J_2}$$

$$I_3 = \frac{J_1 - J_2}{J_3}$$

Using inertia ratios  $I_1$ ,  $I_2$ , and  $I_3$ , the system model (1) can be rewritten as follows:

$$\dot{\omega}_1(t) = I_1\omega_2(t)\omega_3(t) + \frac{u_1(t)}{J_1} \quad (2a)$$

$$\dot{\omega}_2(t) = I_2\omega_3(t)\omega_1(t) + \frac{u_2(t)}{J_2} \quad (2b)$$

$$\dot{\omega}_3(t) = I_3\omega_1(t)\omega_2(t) \quad (2c)$$

### III. DESIGN OF FEEDBACK CONTROL SYSTEM

In this section, we design the feedback control system for stabilizing the rotational motion of a spacecraft with two independent torque inputs.

First, let the dummy output  $y$  be defined as follows:

$$y = \begin{bmatrix} y_1 \\ y_2 \end{bmatrix} = \begin{bmatrix} \omega_1 - \frac{\omega_3}{I_3} \\ \omega_2 + k_3\omega_3^2 \end{bmatrix}, \quad (3)$$

where let  $k_3 > 0$  denote the feedback gain. It follows from system equations (2) that the time derivative of  $y$  is given by

$$\dot{y}_1 = I_1\omega_2\omega_3 - \omega_1\omega_2 + \frac{u_1}{J_1}, \quad (4a)$$

$$\dot{y}_2 = I_2\omega_3\omega_1 + 2k_3I_3\omega_1\omega_2\omega_3 + \frac{u_2}{J_2}. \quad (4b)$$

Choosing the following control inputs

$$u_1 = J_1(-I_1\omega_2\omega_3 + \omega_1\omega_2 - k_1y_1), \quad (5a)$$

$$u_2 = J_2(-I_2\omega_3\omega_1 - 2k_3I_3\omega_1\omega_2\omega_3 - k_2y_2) \quad (5b)$$

yields

$$\dot{y}_1 = -k_1y_1, \quad (6a)$$

$$\dot{y}_2 = -k_2y_2, \quad (6b)$$

where let  $k_1 > 0$  and  $k_2 > 0$  denote the feedback gains. It follows from (6) that  $y = 0$  is asymptotically stable and  $y$  exponentially converges to zero. The trajectory of solutions on the zero output  $y = 0$  is called the zero dynamics.

It is seen from (3) that the following relations are satisfied on the zero dynamics  $y = 0$ .

$$\omega_1 = \frac{\omega_3}{I_3}, \quad (7a)$$

$$\omega_2 = -k_3\omega_3^2. \quad (7b)$$

Substituting (7a) and (7b) into (2c) yields

$$\dot{\omega}_3 = -k_3\omega_3^3. \quad (8)$$

Then, it is seen from (8) that  $\omega_3 = 0$  is asymptotically stable and  $\omega_3$  converges to zero. Therefore, it follows from (7) that  $y_1$  and  $y_2$  also converge to zero when  $\omega_3$  converges to zero. Consequently, we see that the rotational motion of a spacecraft can be stabilized using the two control torque inputs (5a) and (5b).

For an example, the time responses of the angular velocities of a spacecraft using control inputs (5a) and (5b) is shown in Fig. 2. The initial angular momentum is set as  $\|\omega(0)\| = 3$ . The principal moments of inertia are set as  $J_1 = 10$ ,  $J_2 = 5$ , and  $J_3 = 15$ . The feedback gains are set as  $k_1 = k_2 = 10$ .

Fig. 2 shows that all the trajectories of solutions enter into zero dynamics  $y = 0$ , then all angular velocities converge to zero.

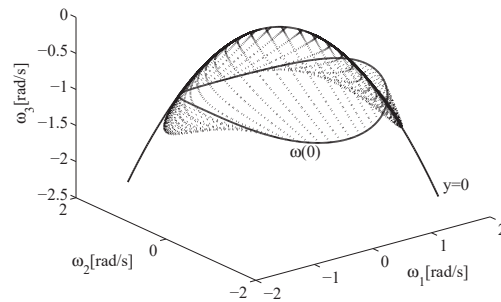

Fig. 2 A schematic view of the trajectories of solutions

Taking the fact into consideration that the actuators such as thruster jets used for the attitude control of spacecrafts yield discrete-level inputs, we next consider the quantized control system.

Here, we introduce the simple uniform quantizer (SUQ) defined by

$$v(t) = q(u(t)), \quad (9)$$

where  $q$  denotes the static nearest-neighbor quantizer toward  $-\infty$  with the quantization interval  $d$  as shown in Fig. 1 of [22].

On the other hand, we introduce the random dither quantizer (RDQ) defined by

$$v(t) = q(u(t) + \eta(t)), \quad (10)$$

where  $\eta(t)$  is an independent and identically distributed random variable with the uniform probability distribution on  $[-d/2, d/2]$ .

Hereafter, we consider the stabilization problem of rotational motion of a spacecraft with quantized control inputs governed by the following equations:

$$\dot{\omega}_1(t) = I_1\omega_2(t)\omega_3(t) + \frac{v_1(t)}{J_1} \quad (11a)$$

$$\dot{\omega}_2(t) = I_2\omega_3(t)\omega_1(t) + \frac{v_2(t)}{J_2} \quad (11b)$$

$$\dot{\omega}_3(t) = I_3\omega_1(t)\omega_2(t) \quad (11c)$$

#### IV. MAIN RESULTS

In this section, we show the control performances of spacecrafts with quantized controls governed by (11) for both cases of the SUQ (simple uniform quantizer) and the RDQ (random dither quantizer). The parameters employed in the numerical simulations are as follows:  $J_1 = 1$ ,  $J_2 = 2$ ,  $J_3 = 3$ ,  $k_1 = 1$ ,  $k_2 = 1$ ,  $k_3 = 10$ ,  $d = 1$ . Time responses of the angular velocities  $\omega_1$ ,  $\omega_2$ , and  $\omega_3$  of quantized control system (11) for both cases of the SUQ and the RDQ are shown in Figs. 3-5. Fig. 6 shows the time response of the Euclid norm of angular velocity. Those figures verify the effectiveness of the proposed RDQ method. We can see from Figs. 3-6 that the proposed RDQ method exhibits much better performance than the SUQ method for the stabilization of rotational motion of a spacecraft. Figs. 7 and 8 show the difference between the quantized control inputs using the SUQ method and the RDQ method. We can see from Figs. 7 and 8 that the quantized control inputs using the proposed RDQ method are well adjusted to decrease the quantization errors rather than the ones using the SUQ method.

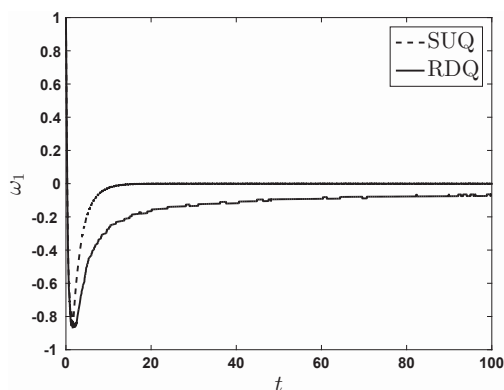

Fig. 3 Time responses of  $\omega_1$  for both cases of SUQ and RDQ

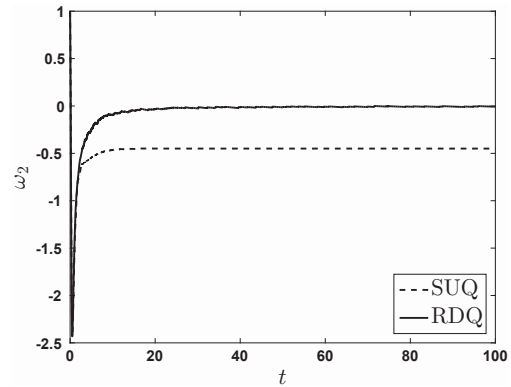

Fig. 4 Time responses of  $\omega_2$  for both cases of SUQ and RDQ

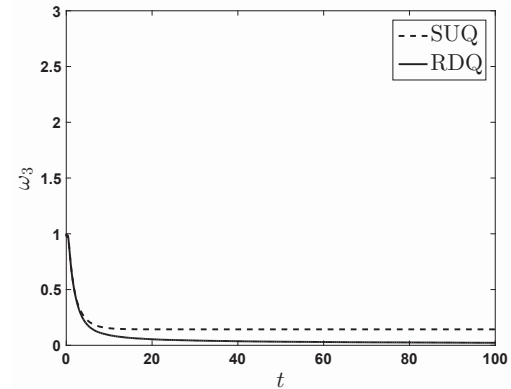

Fig. 5 Time responses of  $\omega_3$  for both cases of SUQ and RDQ

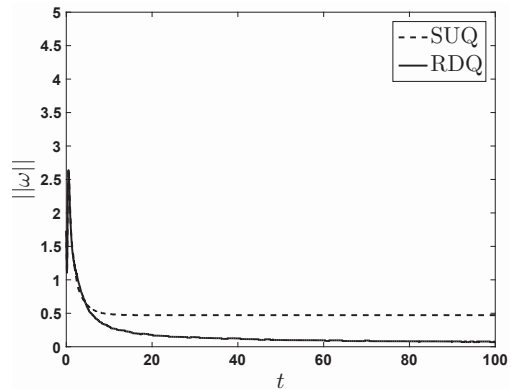
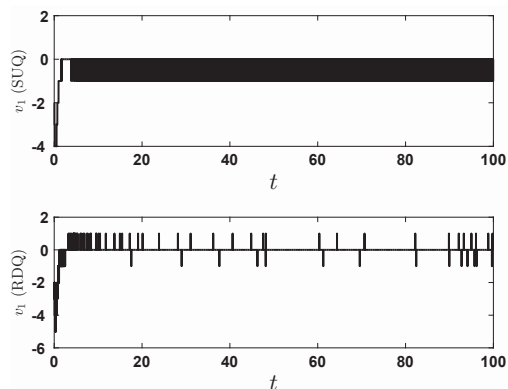
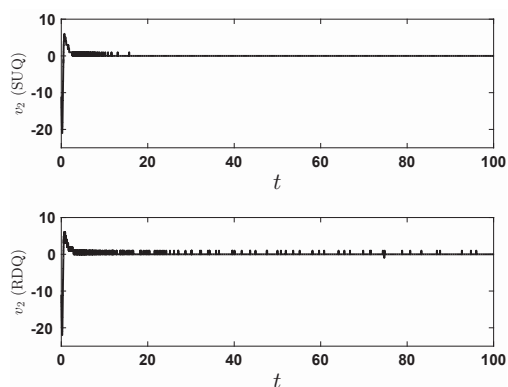

Fig. 6 Time responses of  $\|\omega\|$  for both cases of SUQ and RDQ

#### V. CONCLUSION

In this study, we have examined the stabilization problem of rotational motion of a spacecraft with two control torque inputs. The control method for a spacecraft equipped with two control torques is useful to recover the case when one of the nominal three thruster jets had failed or to reduce the consumption of propulsive fuel. Furthermore, motivated by the fact that the actuators such as thruster jets used for the attitude control of spacecrafts yield discrete-level inputs, we have studied the control problem of quantized system for stabilizing

Fig. 7 Time responses of  $v_1$  for both cases of SUQ and RDQFig. 8 Time responses of  $v_2$  for both cases of SUQ and RDQ

the rotational motion of a spacecraft with two torque inputs. The random dither quantization method that transforms a given continuous-valued signal to a discrete-valued signal by adding artificial random noise to the continuous-valued signal before quantization was applied to the control method for stabilizing the rotational motion of a spacecraft with two torque inputs. Consequently, this paper proposed a control method based on the random dither quantization method for the stabilization of rotational motion of a spacecraft using two control torque inputs. The effectiveness of the proposed method is verified by numerical simulations. It is known that not only quantization errors but also time delays may cause performance deterioration of control systems [24]-[29]. The control problem of random dither quantized systems with time delays is a possible future work.

#### REFERENCES

- [1] P. E. Crouch, Spacecraft Attitude Control and Stabilization: Applications of Geometric Control Theory to Rigid Body Models, *IEEE Transaction on Automatic Control*, Vol. 29, No. 4, pp. 321-331, 1984.
- [2] R. W. Brockett, Asymptotic stability and feedback stabilization, *Differential Geometric Control Theory*, Birkhäuser, pp. 181-191, 1983.
- [3] D. Aeyels, Stabilization by smooth feedback of the angular velocity of a rigid body, *Systems & Control Letters*, Vol. 6, No. 1, pp. 59-63, 1985.
- [4] R. Outbiv and G. Sallet, Stabilizability of the angular velocity of a rigid body revisited, *Systems & Control Letters*, Vol. 18, No. 2, pp. 93-98, 1992.
- [5] R. T. M'Closkey and R. M. Murray, Exponential Stabilization of Driftless Nonlinear Control Systems Using Homogeneous Feedback, *IEEE Transaction on Automatic Control*, Vol. 42, No. 5, pp. 614-628, 1997.
- [6] C. I. Byrnes and A. Isidori, On the Attitude Stabilization of Rigid Spacecraft, *Automatica*, Vol. 27, No. 1, pp. 87-95, 1991.
- [7] J.-M. Coron and E.-Y. Keraï, Explicit Feedbacks Stabilizing the Attitude of a Rigid Spacecraft with Two Control Torques, *Automatica*, Vol. 32, No. 5, pp. 669-677, 1996.
- [8] P. Morin and C. Samson, Time-Varying Exponential Stabilization of a Rigid Spacecraft with Two Control Torques, *IEEE Transaction on Automatic Control*, Vol. 42, No. 4, pp. 528-533, 1997.
- [9] T. Hashimoto, I. Yoshimoto, T. Ohtsuka, Probabilistic Constrained Model Predictive Control for Schrödinger Equation with Finite Approximation, *Proceedings of SICE Annual Conference*, pp. 1613-1618, 2012.
- [10] T. Hashimoto, Probabilistic Constrained Model Predictive Control for Linear Discrete-time Systems with Additive Stochastic Disturbances, *Proceedings of IEEE Conference on Decision and Control*, pp. 6434-6439, 2013.
- [11] T. Hashimoto, Computational Simulations on Stability of Model Predictive Control for Linear Discrete-time Stochastic Systems, *International Journal of Computer, Electrical, Automation, Control and Information Engineering*, Vol. 9, No. 8, pp. 1385-1390, 2015.
- [12] T. Hashimoto, Y. Yoshioka, T. Ohtsuka, Receding Horizon Control with Numerical Solution for Thermal Fluid Systems, *Proceedings of SICE Annual Conference*, pp. 1298-1303, 2012.
- [13] T. Hashimoto, Y. Yoshioka, T. Ohtsuka, Receding Horizon Control with Numerical Solution for Spatiotemporal Dynamic Systems, *Proceedings of IEEE Conference on Decision and Control*, pp. 2920-2925, 2012.
- [14] T. Hashimoto, Y. Takiguchi and T. Ohtsuka, Output Feedback Receding Horizon Control for Spatiotemporal Dynamic Systems, *Proceedings of Asian Control Conference*, 2013.
- [15] T. Hashimoto, Y. Yoshioka and T. Ohtsuka, Receding Horizon Control for Hot Strip Mill Cooling Systems, *IEEE/ASME Transactions on Mechatronics*, Vol. 18, No. 3, pp. 998-1005, 2013.
- [16] T. Hashimoto, Y. Yoshioka and T. Ohtsuka, Receding Horizon Control With Numerical Solution for Nonlinear Parabolic Partial Differential Equations, *IEEE Transactions on Automatic Control*, Vol. 58, No. 3, pp. 725-730, 2013.
- [17] T. Hashimoto, Y. Takiguchi and T. Ohtsuka, Receding Horizon Control for High-Dimensional Burgers' Equations with Boundary Control Inputs, *Transactions of the Japan Society for Aeronautical and Space Sciences*, Vol. 56, No.3, pp. 137-144, 2013.
- [18] T. Hashimoto, Conservativeness of Probabilistic Constrained Optimal Control Method for Unknown Probability Distribution, *International Journal of Mathematical, Computational, Physical, Electrical and Computer Engineering*, Vol. 9, No. 9, pp. 11-15, 2015.
- [19] T. Hashimoto, A Method for Solving Optimal Control Problems subject to Probabilistic Affine State Constraints for Linear Discrete-time Uncertain Systems, *International Journal of Mechanical and Production Engineering*, Vol. 3, Issue 12, pp. 6-10, 2015.
- [20] T. Hashimoto, Solutions to Probabilistic Constrained Optimal Control Problems Using Concentration Inequalities, *International Journal of Mathematical, Computational, Physical, Electrical and Computer Engineering*, Vol. 10, No. 10, pp. 441-446, 2016.
- [21] T. Hashimoto, Stability of Stochastic Model Predictive Control for Schrödinger Equation with Finite Approximation, *International Journal of Mathematical, Computational, Physical, Electrical and Computer Engineering*, Vol. 11, No. 1, pp. 12-17, 2017.
- [22] T. Hashimoto, Stochastic Model Predictive Control for Linear Discrete-time Systems with Random Dither Quantization, *International Journal of Mathematical, Computational, Physical, Electrical and Computer Engineering*, Vol. 11, No. 2, pp. 130-134, 2017.
- [23] K. Okada, T. Hashimoto, H. Tahara, Attitude Stabilization of Satellites using Random Dither Quantization, *International Journal of Mathematical, Computational, Physical, Electrical and Computer Engineering*, Vol. 11, No. 8, pp.883-887, 2017.
- [24] T. Hashimoto, T. Amemiya and H. A. Fujii, Stabilization of Linear Uncertain Delay Systems with Antisymmetric Stepwise Configurations, *Journal of Dynamical and Control Systems*, Vol. 14, No. 1, pp. 1-31, 2008.
- [25] T. Hashimoto, T. Amemiya and H. A. Fujii, Output Feedback Stabilization of Linear Time-varying Uncertain Delay Systems, *Mathematical Problems in Engineering*, Vol. 2009, Article ID. 457468, 2009.

- [26] T. Hashimoto and T. Amemiya, Stabilization of Linear Time-varying Uncertain Delay Systems with Double Triangular Configuration, *WSEAS Transactions on Systems and Control*, Vol. 4, No.9, pp.465-475, 2009.
- [27] T. Hashimoto, Stabilization of Abstract Delay Systems on Banach Lattices using Nonnegative Semigroups, *Proceedings of the 50th IEEE Conference on Decision and Control*, pp. 1872-1877, 2011.
- [28] T. Hashimoto, A Variable Transformation Method for Stabilizing Abstract Delay Systems on Banach Lattices, *Journal of Mathematics Research*, Vol. 4, No. 2, pp.2-9, 2012.
- [29] T. Hashimoto, An Optimization Algorithm for Designing a Stabilizing Controller for Linear Time-varying Uncertain Systems with State Delays, *Computational Mathematics and Modeling*, Vol.24, No.1, pp.90-102, 2013.