

# Microstrip Patch Antenna Enhancement Techniques

Ahmad H. Abdelgwad

**Abstract**—Microstrip patch antennas are widely used in many wireless communication applications because of their various advantages such as light weight, compact size, inexpensive, ease of fabrication and high reliability. However, narrow bandwidth and low gain are the major drawbacks of microstrip antennas. The radiation properties of microstrip antenna is affected by many designing factors like feeding techniques, manufacturing substrate, patch and ground structure. This manuscript presents a review of the most popular gain and bandwidth enhancement methods of microstrip antenna and reports a brief description of its feeding techniques.

**Keywords**—Gain and bandwidth enhancement, slotted patch, parasitic patch, electromagnetic band gap, defected ground, feeding techniques.

## I. INTRODUCTION

WITH the dynamic development in wireless communication technology, the need for compact size, light weight, cost effective and low profile antenna has increased significantly. Microstrip antennas were designed to achieve these requirements. Microstrip antenna is formed conventionally by a dielectric substrate covered with two metallic sheets on both sides; one of them is the radiating patch while the other is the ground. Patches can be in many different geometrical shapes like rectangular, circular, triangular, square etc. Microstrip antennas are widely utilized because of being compact, low cost, conformal and suitable to integrate with Radio Frequency (RF) devices. In addition, they can provide feed flexibility, different polarizations, multiband, and beam steering [1]. In spite of these advantages, the main problems of microstrip antennas are narrow bandwidth and low gain which restrict them from many wireless communication systems. Three kinds of losses degrade the performance of the microstrip antenna: Dielectric loss, conductor loss and surface wave loss. The dielectric loss and the conductor loss rely on the quality of the manufacturing materials of the substrate and conductors respectively. With high quality selection of substrate and conductor, dielectric and conductor losses can be reduced therefore the gain of the antenna will be enhanced. The gain can be further enhanced by suppressing surface wave. The surface waves reduce the efficiency of the antenna as a part of the available power trapped in the substrate layer. The substrate permittivity and thickness has a significant effect on the propagation of surface waves [2].

In recent times, many attempts have been presented to overcome the microstrip antenna limitations. High impedance surfaces, like electromagnetic band gap (EBG), are used to

degrade the surface wave losses. These structures can block or allow the electromagnetic waves in certain frequency bands [3]. These structures are used to forbid the surface wave over the operating frequency range. As these waves cannot propagate through the substrate, the amount of the radiated power increases, hence the gain and efficiency increase. Other techniques that are used to reduce the losses of surface wave are by utilizing hybrid substrates [4], by using superstrate [5] etc. However, the main problem of these methods is the fabrication complexity due to the large number of vias and holes required in these techniques. Another simple technique, known as suspended patch antenna, is used to reduce the surface wave by replacing the substrate with air or very low dielectric constant material [6]. The suspended patch antenna needs an air gap which is formed by a spacing material like foam for fabrication but the antenna becomes fragile and not durable, hence it is unsuitable for mass production. For more practical fabrication process, lower dielectric constant can be achieved by partially removing the substrate surrounding the patch [7].

The direct way to enhance the bandwidth of the microstrip antenna is to increase the substrate thickness, but the efficiency decreases due to the large amount of input power dissipated in the resistor which reduces the amount of radiated power. Many techniques were developed to enhance the microstrip patch antenna performance such as slotted patch antenna, parasitic patch, defective or partial ground structures, patch array, metallic rings, and reflecting layer [8]-[12]. Hence, the main aim of this paper is to present a survey of the enhancement techniques of gain as well as bandwidth of microstrip patch antennas which has triggered many novel antenna applications. In addition, a brief review of various feeding techniques of microstrip antenna is also presented.

## II. GAIN AND BANDWIDTH ENHANCEMENT TECHNIQUES

Numerous techniques are adopted recently to improve the gain, bandwidth and efficiency of microstrip antennas. A brief insight about these popular techniques is outlined as follow:

### A. Slotted Patch

The conventional microstrip antenna has narrow bandwidth; one of popular techniques to enhance the bandwidth is done by cutting slots in the patch of half wavelength along the desired resonance frequency [8]. The slots are implanted on the patch to enhance the impedance matching, especially at higher frequencies. The current distribution on the patch is changed as a result of the cut slots, hence the input impedance and current path length changes [9]. By adding new slots into the patch, new resonance frequencies are created. The positions and dimensions of the slots should be properly optimized where the first two broadside radiation modes of the radiating patch

Ahmad H. Abdelgwad is with the Department of Electrical Engineering, Faculty of Engineering, Fayoum University, Fayoum, 63514 Egypt (phone: +201007665621; e-mail: aha05@fyoum.edu.eg)

are perturbed where the resonance frequencies of the patch become close to each other to achieve a wider bandwidth [10].

Cutting slots method on the radiating patch is effectively used to reduce the size of the microstrip antenna and create multiple frequency bands at the desired frequency range by optimizing the slots configurations to produce the desired resonant mode. Slots cut into the patch are of different shapes. The commonly utilized slots are U-slot, H-slot, T-slot, E-slot etc. Bandwidth of 30.3% has been achieved by etching an E-shaped slot in a rectangular patch [11]. Impedance bandwidth of 26% is achieved by cutting a U-shaped slot in [8]. In [12], a design of C-slotted patch is proposed to enhance the gain and provide a bandwidth of 50% from 1 GHz to 3 GHz. The design of the C-slot antenna is shown in Fig. 1

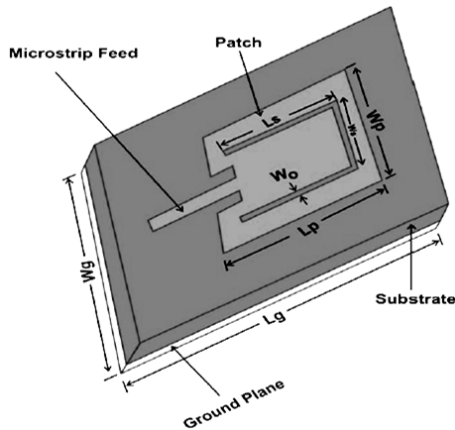

Fig. 1 C-Shaped Slotted Antenna [12]

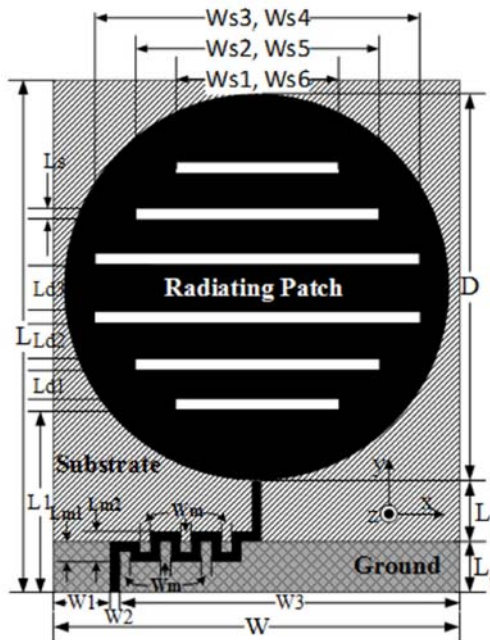

Fig. 2 Circular patch antenna with horizontal slots [13]

The bandwidth of microstrip antenna relies on the quality factor. Hence, when the patch id is modified by slots, it stores

less energy beneath the patch and the quality factor degrades. So, it provides higher radiation [1]. A circular patch with mirrored horizontal slots is designed by Ahsan et al. [13] as shown in Fig. 2. This configuration can achieve lower resonance frequencies due to the extension of the current distribution with the fundamental resonant mode.

**B. Parasitic Patch/Multi-Resonator**

In this method, additional resonators are utilized to improve the bandwidth and the gain of the microstrip antenna. The parasitic patches are coupled to main patch. Two different configurations of parasitic patch are used which are coplanar technique and multilayer technique. These techniques are outlined in the following subsections.

**1. Coplanar Techniques**

In coplanar technique, additional patches are incorporated on a single plane above the substrate. The excitation is given to a patch which is called the main patch or the active patch. The parasitic patch is excited if it is placed near to the active patch because of the direct coupling between them. Wider bandwidth can be accomplished if the resonance of the active patch is close to the resonance of the parasitic patch. Parasitic patches can be single patch or two symmetrical patches along the main patch edges. For rectangular patch antenna, the edges along the width of the patch are known as the radiating edge while the edges along the length are known as the non-radiating edge. In case of placing a parasitic patch on one of the radiating edges, a wide bandwidth is achieved, however this leads to 45 degrees shift of the beam maxima and the radiation pattern becomes unsymmetrical along the broadside direction. To achieve a symmetrical pattern, two equal gap coupled patches are utilized on the both radiating edges of the patch where the net effect on the beam shift is zero. Three resonant frequencies can be generated by using two different lengths of the parasitic patches. It may lead to shift of the beam maxima but the shift is acceptable. U-shaped parasitic patches which are placed along the radiating edges are shown in Fig. 3 [14].

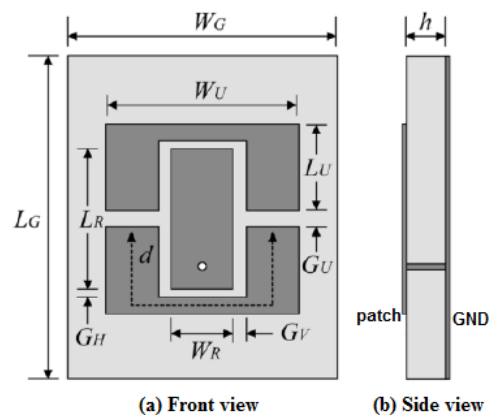

Fig. 3 U-shaped parasitic patch geometry [14]

Different configurations of directly and indirectly coupled parasitic patches have been designed in [15]. The

configuration of the antenna is shown in Fig. 4. The impedance bandwidth has increased from 2% up to 12.7%. The proposed antenna provides six times the conventional antenna. Utilizing parasitic patches may increase the antenna size however; the bandwidth is higher compared to a single patch antenna.

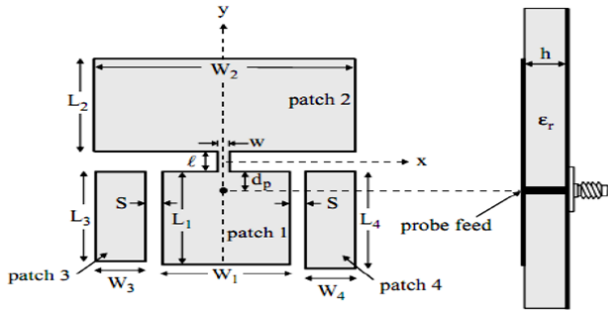

Fig. 4 Multi-resonator patch antenna geometry [15]

## 2. Multilayer/Stacked Techniques

In multilayer structure, a patch is used above another one with superseding dielectric substrate in between. This makes two or more patches to share the same aperture area. In this configuration, lower dielectric constant material is usually added above the radiating patch to minimize the effective permittivity of the multilayer antenna. This increases the gain of the antenna. A stacked antenna provides a compact size and helps to reduce the surface wave losses [16]. The most popular coupling techniques in multilayer structure are electromagnetic coupled and aperture coupled microstrip antenna. Multilayer structure is utilized to provide a wide bandwidth of 114% with two resonance frequencies within the band 3 GHz up to 11 GHz [17]. The design presents additional c-slot in the ground plane and the bandwidth is enhanced more by etching E-slot on the parasitic patch. At the centre frequency 7 GHz, 12 dB gain is obtained. There are two configurations of electromagnetically coupled multilayer patch antenna which is depicted in Fig. 5. The lower patch is fed with coaxial cable while the upper patch is excited by electromagnetic coupling. Patches are fabricated on different substrate materials and air gap is introduced between the two materials.

### C. Metallic Rings

For circular patch antenna, metallic rings around the active patch are used to scatter the surface wave to enhance the radiation. When electromagnetic waves hit an interface that has small dimensions compared to the wavelength of the incident wave, the electromagnetic waves are scattered in all directions [18]. The scattered waves are added to the incident waves resulting in-phase and out-of-phase interference and the rest can reradiate by the antenna. Based on this concept, placing metallic rings around the main patch helps scatter the surface waves and to convert it to space wave to enhance the gain of the microstrip patch antenna. Circular patch antenna surrounded by two metallic rings is proposed in [19] and the geometry is shown in Fig. 6. The proposed design provides enhancement of 6.7 dB in the gain compared to the conventional antenna without the metallic rings.

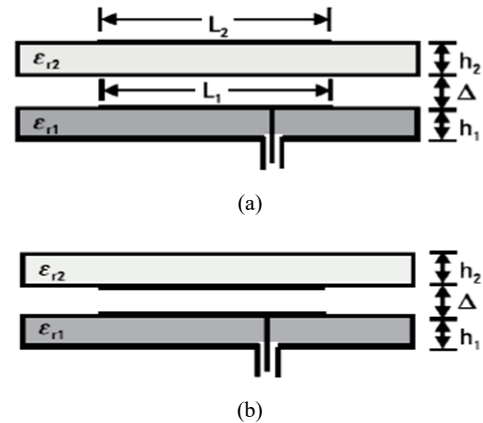

Fig. 5 Electromagnetically coupled multilayer structure (a) normal geometry (b) inverted geometry

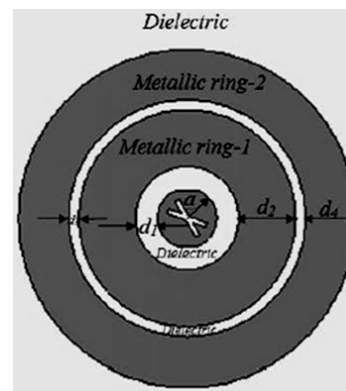

Fig. 6 Circular patch antenna with metallic rings [19]

### D. EBG

EBG structures are artificial periodic dielectric materials that produce stop band and pass band properties. The periodic nature of EBG structure suppresses the propagation of surface waves within a certain frequency, called a band gap, which provides additional control of the electromagnetic waves compared to conventional filtering and guiding structures. Surface wave suppression provides a significant improvement of the maximum gain, bandwidth and efficiency when EBG is utilized in the microstrip antenna as the generation of surface waves degrades the radiation pattern and the antenna efficiency [1]. Structures of EBG are realized by periodic configuration of dielectric substrate materials or metallic conductor as an artificial magnetic ground plane. In other words, EBG can be achieved by drilling a periodic pattern of holes in the substrate material or by etching a periodic configuration in the ground plane. The properties of EBG rely on the size, shape, symmetry and the used material in their configuration.

In general, EBG can be classified into three types according to their geometric design which are one-dimensional transmission line, two-dimensional planar surfaces, and three-dimensional volumetric structure [20]. Two-dimensional planar surfaces are classified into uni-planar and mushroom like EBG surfaces. Two-dimensional mushroom like EBG

configuration is preferred because of its light weight and inexpensive fabrication cost and it is portrayed in Fig. 7. The main parameters that control the performance of mushroom like EBG configurations are the substrate thickness, the rectangular width, the gap width, and the substrate permittivity. These designing parameter are directly related to the resonance wavelength of the antenna [21].

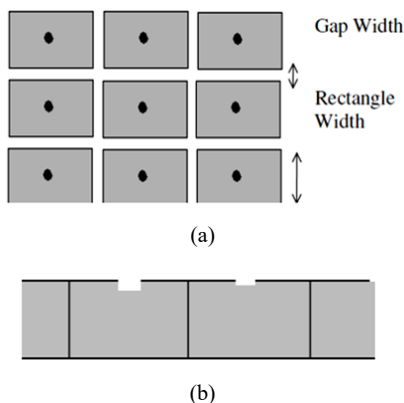

Fig. 7 Two-dimensional mushrooms like EBG surfaces (a) Top view (b) side view

Circular patch antenna performance may be enhanced by utilizing cylindrical EBG substrate [22]. The cylindrical EBG can be a combination of two periodic configurations with different periods. One of them is made of grounding vias and the other one of metallic rings, which are arranged to form a circularly periodic structure. The geometry of cylindrical EBG is shown in Fig. 8.

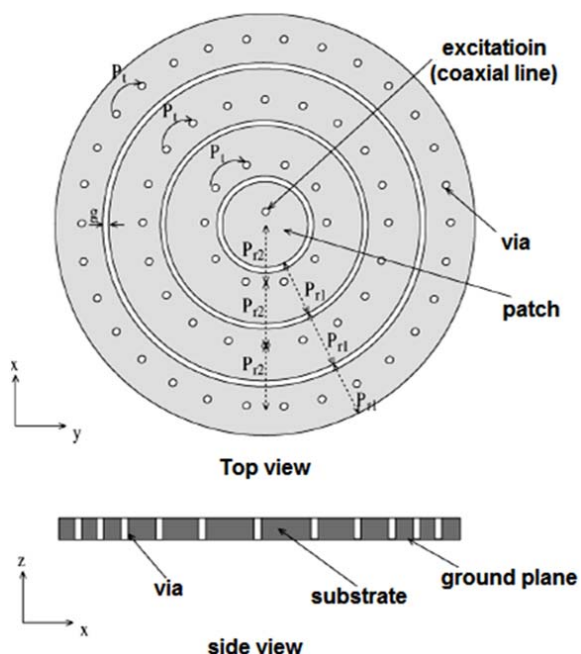

Fig. 8 Circular patch antenna with a cylindrical EBG substrate [22]

*E. Defected Ground Structure (DGS)*

The geometry and dimensions of the ground plane have a significant effect on the excitation mode and the operating bandwidth of the microstrip antenna. Defected ground structures may be accomplished by cutting a defect of any configuration on the ground plane. This defect disturbs the current distribution in the ground plane and helps control input impedance and excitation of radio waves in the substrate. The ground defect may be varied accordingly from simple configuration to more complex configuration to achieve the optimum performance [1]. However, the absence of the conducting ground may lead to the increase of the back lobe radiation to enhance the directivity; a reflecting layer behind the antenna is used to reflect back the back lobe radiation [23]. Fig. 9 depicts a view of a periodic defected ground plane.

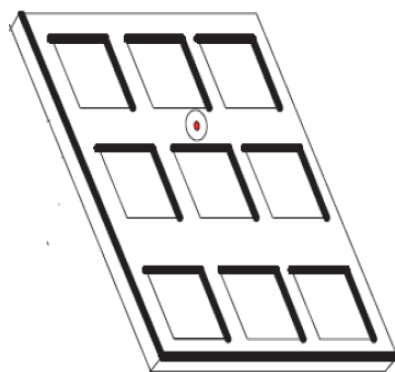

Fig. 9 Periodic defected ground plane

Defected ground structure and EBG have similar microwave circuit properties to provide a band stop or band pass like filter. A large area is required to construct the periodic pattern EBG implementation. In addition, defining the unit element of EBG is difficult whereas defected ground structures can be one or few etched shapes which do not need for a large implementation area and it can easily define the unit element. The effect of hexagonal shape defected ground structure is proposed in [24] to provide significant enhancement of the radiation characteristics by suppressing of the surface wave. The geometry of double hexagonal DGS design is shown in Fig. 10.

*F. Reflecting Layer*

The utilization of reflector planes or partial reflective surfaces is commonly used for maximizing the directivity and gain of microstrip antennas in the cost of the operating bandwidth. In this technique, half wavelength in terms of resonant frequency is a reasonable resonant cavity between the reflective surface and the metallic ground plane. However the cavity gap can be minimized to quarter wavelength utilizing an artificial magnetic conductor, but the thickness cannot be completely mitigated [25]. A U-shaped metal reflector is designed to achieve a unidirectional propagation with high directivity and front-to-back ratio [26]. In addition, multiple metal back reflectors design is presented for a wide-band slot

antenna [27]. The geometry of the microstrip antenna with reflector is shown in Fig. 11 where the reflector comprises of a substrate coated with a conducting layer such as perfect electric conductor (PEC).

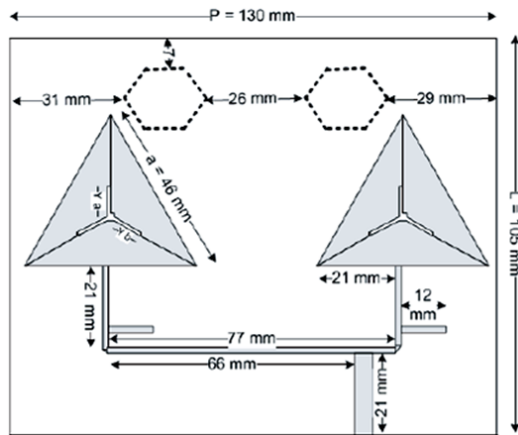

Fig. 10 Geometry of double hexagonal DGS [24]

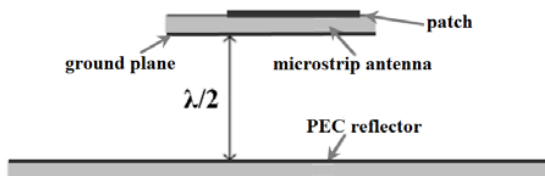

Fig. 11 MSA with reflector configuration

To get better performance, metasurface reflector (MSR) structure is used to reflect the unwanted back radiation by artificially engineering the metallic reflector surface. The MSR structure can be proposed based on mesh grid array configuration which is first designed by Enoch et al. [28]. The metasurface is a two dimensional metamaterial which offers a less lossy structure and less physical space to provide artificial control of microwaves through it. The basics structure of MSR includes a periodic planar metallic surface which interacts with the incident electromagnetic beam. The metallic elements behave as an inductive grid and the space between them resembles capacitive grid. The copper elements of MSR produce in-phase currents with the original one of the microstrip antenna, so more directive emission may be produced. Based on this phenomenon, the MSR can reduce the back radiation and increase the directivity. The mutual coupling between the microstrip antenna and the MSR structure should be seriously considered and the impedance matching has to be investigated by optimizing the separation distance. MSR structure of a planar array of square shaped element is proposed in [13]. The prospective view of MSR loaded patch antenna is shown in Fig. 12. The square-shaped elements of MSR structure have been widely studied because of their good performance [29].

#### G. Partial Substrate Removal

The substrates are used mainly to provide mechanical

strength to the microstrip antenna. The substrate material has a significant effect on the microstrip antenna parameters such as the bandwidth, radiation pattern, gain and efficiency. The partial substrate removal can also minimize the propagation of surface waves. Compared to the conventional antenna, partial substrate removal may enhance the gain due to the reduction of surface wave losses and dielectric losses and without affecting the mechanical strength of the antenna or the patch size. Partial substrate removal surrounding a rectangular patch is proposed to improve the microstrip antenna performance by surface waves suppressing [7]. This technique may be referred as open air cavity as the removed substrate may be a large part. The designed antenna is fed with aperture coupling technique and its geometry is shown in Fig. 13.

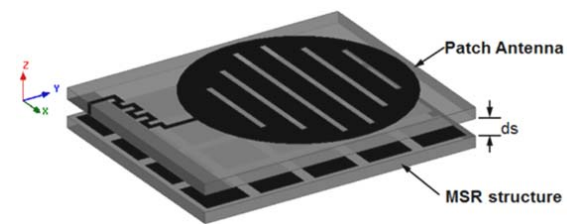

Fig. 12 Perspective view of MSR loaded microstrip antenna [13]

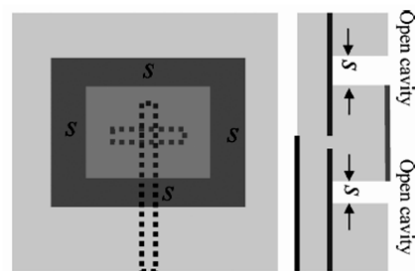

Fig. 13 Partial substrate removal surrounding the patch [7]

#### H. Antenna Array

The most popular technique to obtain high gain of the antenna is to use multiple elements as an array that is excited through a feeding network. However, antenna arrays usually require large size and the design of the feeding network is complex to obtain the desired phase response to reduce the unstable radiation performance and signal loss. Generally, the radiation pattern of a single microstrip antenna element is wide and provides low gain. Antennas with directive radiation are preferred for many applications to provide long distance communication. This can be accomplished by utilizing an array of radiating elements configured in different geometrical structures. Usually, the elements of the array are identical to provide simpler, convenient, and more practical design [30]. The total radiated field of the array can be determined by the vector addition of the radiated field via the individual elements assuming that the current in each element is equivalent to that of the isolated element i.e. neglect coupling. This usually depends on the separation between the elements. To achieve directive patterns, the fields of elements have to add (interfere constructively) in the desired directions and cancel each other

(interfere destructively) in other directions. The overall performance of antenna array depends mainly on many factors which are the configuration of the array such as linear, rectangular, circular, etc., the relative pattern of the radiating elements, the excitation amplitude and phase of elements, and the spacing between elements [31]-[40]. An example of four element microstrip array is shown in Fig. 14.

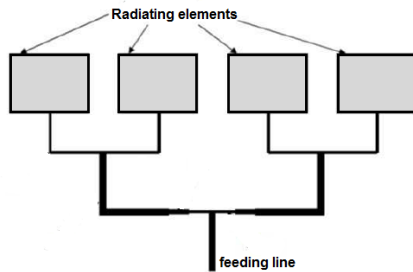

Fig. 14 Four element microstrip patch array

### III. MICROSTRIP ANTENNA FEEDING TECHNIQUES

Many techniques can be utilized to feed the microstrip patch antennas and they may be classified into contacting feed techniques and non-contacting feed techniques. The patch is directly physically connected to RF power source in contacting techniques. The widely used contacting techniques are microstrip feed and coaxial or probe feed. In non-contacting feed technique, the power is transferred to the patch by

electromagnetic coupling and there is no physical connection between the patch and the power source. The widely utilized non-contacting feed methods are aperture coupling and proximity coupling feed techniques. These techniques are briefly illustrated as follows:

#### A. Contacting Techniques

##### 1. Microstrip Feed

In microstrip feed technique, a conducting strip is connected directly to the patch boundary. This strip has a narrow width compared to the patch. The microstrip line feed structure is portrayed in Fig. 15. The main advantage of this technique is that it provides a planar structure where the feed line is etched on the substrate [41]. Inset cut is etched in the patch to provide impedance match between the patch and the feed line. Additional matching elements are not required. The dimensions and position of the inset cut have to be designed properly to provide perfect impedance matching. This technique accomplishes ease of modelling and fabrication. The major drawback of this technique is, when the substrate thickness increases, the surface waves and feed radiation increase, which degrades the antenna performance. The meander stripline feed may help to reduce the input impedance mismatch so it provides significant enhancement of the bandwidth and return loss. The meander strip line feed structure is depicted in Fig. 2 [13].

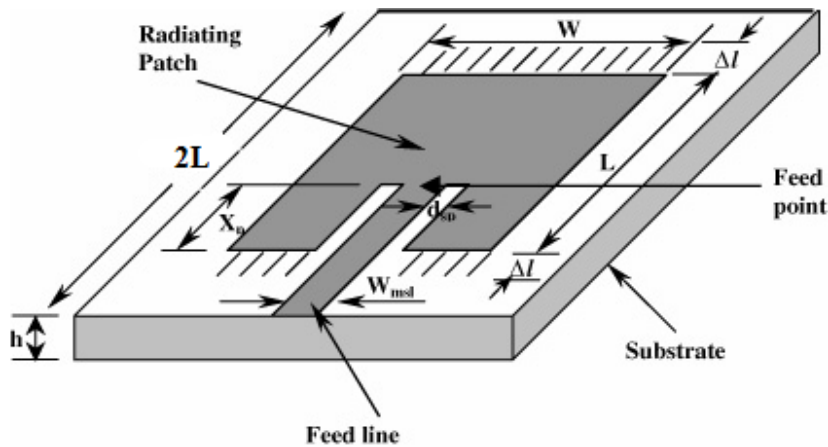

Fig. 15 Microstrip line feed structure

##### 2. Coaxial Feed

In coaxial feed technique, the inner conductor of the coaxial is pulled out to the patch through the substrate material and the outer conductor is connected to the ground as shown in Fig. 16. The main advantages of this technique are that it can be connected to the patch at any position to provide the impedance matching and it is compatible with coaxial cables. However, it is complicated to model and does not provide complete planar structure. In addition, for thick substrates, the input impedance is more inductive due to the increase of probe length which leads to impedance mismatch problems [42].

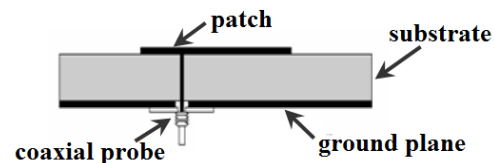

Fig. 16 Coaxial feed structure

#### B. Non-Contacting Techniques

##### 1. Aperture Coupling

In aperture coupling feed technique, the ground plane is

sandwiched between two substrates and an aperture is cut in the ground to provide electromagnetic coupling between the microstrip line feed on the lower substrate and the radiating patch on the upper substrate. The aperture is cut at the center location of the patch to achieve symmetrical radiation pattern, low cross polarization, and maximum coupling. The amount of coupling relies mainly on the shape, size, and position of the aperture. The radiation losses are minimized because of the isolation between the patch and the feed line by the ground plane. The performance of aperture coupled microstrip antenna relies on many parameters such as the patch dimensions, the aperture configuration, the substrate thickness, and the feed network. These parameters are analyzed in [43]. With the increase of the aperture size, the coupling and the input impedance increases and vice versa. Hence, the slot dimensions and configuration should be optimized to get the desired performance. The permittivity and thickness of the two substrates should be chosen carefully to optimize the different functions of circuitry and radiation. Usually, a high dielectric material is employed for the lower substrate while a material with low dielectric constant is used for the upper substrate to optimize the patch radiation [44]. The main drawback of this technique is the fabrication complexity of the design due to its alignment difficulty in multi-layers. The structure of the aperture coupled feed technique is shown in Fig. 17.

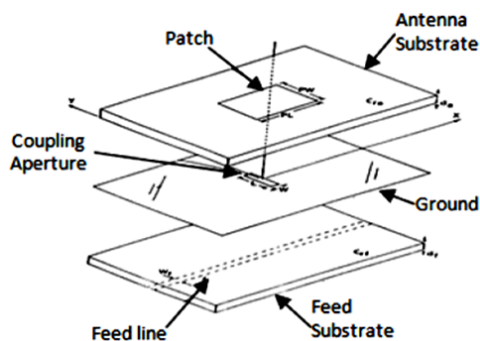

Fig. 17 Aperture coupled feed structure

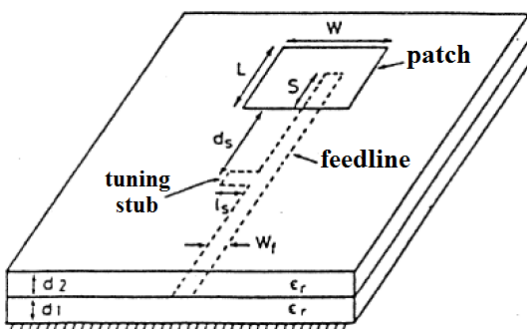

Fig. 18 Proximity coupling feed structure

## 2. Proximity Coupling

In proximity coupling feed method, the feed line is placed between two substrates while the patch is etched on the upper substrate and the ground on the lower substrate. This technique

is preferred as it degrades the undesired feed radiation and achieves a very wide bandwidth. The utilization of two different substrates, one for the radiating patch and another one for the ground, helps optimize the individual performances. The main drawback of proximity coupling method is its fabrication complexity due to the difficulty of proper alignment of the dielectric layers [45]. The structure of proximity coupled microstrip antenna is shown in Fig. 18.

## IV. CONCLUSIONS

Microstrip patch antennas have many advantages; however narrow bandwidth and low gain and efficiency are their main drawbacks. Hence, numerous techniques have been investigated to enhance these drawbacks. In this paper, most of these techniques are briefly reviewed and discussed. It is observed from this survey that there is a particular relationship among gain, bandwidth and size of the microstrip antenna. It is recognized that if there is enhancement in one property, it is frequently accompanied by degradation of other property. For instance, if the antenna size decreased then it is usually at the expense of the gain and bandwidth. The three parameters can be simultaneously balanced by the utilization of variety of microstrip antenna topologies and composite enhancement techniques. Popular feeding methods of microstrip antenna are also summarized in this manuscript. It is observed that contacting methods such as microstrip and coaxial feed are easy and implement. However, non-contacting techniques like aperture coupled feed and proximity coupled feed can achieve wider bandwidth and higher gain but they are difficult to implement due to the alignment of multi-substrates.

## REFERENCES

- [1] C. A. Balanis, "Antenna theory analysis and design", 2nd edition, John Wiley and Sons, 2009.
- [2] M. N. Aktar, M. S. Uddin, M. R. Amin, and M. M. Ali "Enhanced Gain and Bandwidth of Patch Antenna Using EBG Substrates," *International Journal Of Wireless & Mobile Networks (IJWMN)*, Vol. 3, No. 1, Feb. 2011.
- [3] Gonzola, D. Maagt, and sorola "Enhanced patch-antenna performance by suppressing surface waves using photonic-bandgap substrates," *IEEE Trans. Microwave Theory Techn.*, Vol. 47, pp. 2131-2138, Nov. 1999.
- [4] A. Rivera-Albino and C.A. Balanis, "Gain Enhancement in Microstrip Patch Antennas Using Hybrid Substrates," *IEEE Antennas and Wireless Propagation Letters*, vol. 12, pp. 476-479, April 2013.
- [5] H. Attia and L. Yousefi, "High-Gain Patch Antennas Loaded with High Characteristic Impedance Superstrates," *IEEE Antennas and Wireless Propagation Letters*, vol. 10, pp.858-861, August 2011.
- [6] Z. N. Chen, "Broadband probe-fed plate antenna," in *Proc. 30th Eur. Microwave Conf.*, pp. 1-5, Oct. 2000.
- [7] S. B. Yeap, and Z. N. Chen, "Microstrip patch antennas with enhanced gain by partial substrate removal," *IEEE Transactions on Antennas and Propagation*, vol. 58, no. 9, September 2010.
- [8] S. Kumar Sharma and M. Rattan, "Analysis of Broad Banding and Minimization Techniques for Square Patch Antenna" *IETE journal of research*, vol. 56, no. 2, April 2010.
- [9] D. Chen, and C. H. Cheng, "A novel compact ultra-wideband (UWB) wide slot antenna with via holes" *Progress In Electromagnetics Research*, vol. 94, pp. 343- 349, 2009.
- [10] S. S. Yang, A. A. Kishk, and K. Lee "Frequency Reconfigurable U-slot Microstrip Antenna" *IEEE antenna and wireless propagation letters* vol. no. 7, 2008.
- [11] F. Yang, X. Zhang, X. Ye, Y. R. Samii "Wide band E- shaped patch antennas for wireless communications" *IEEE transactions on antennas and propagation*, vol. 49, no. 7, July 2001.

- [12] A. Singh, A. Arya & S. Sharma, "High Gain of C Shape Slotted Microstrip Patch Antenna for Wireless System," *International Journal of Applied Engineering Research*, vol.7, no.11, 2012.
- [13] M. R. Ahsan, M. T. Islam, M. H. Ullah, M. J. Singh, M. T. Ali, "Metasurface Reflector (MSR) Loading for High Performance Small Microstrip Antenna Design," *PLOS ONE*, vol 10, no 5, pp 1-20, May 2015.
- [14] S. Wi, Y. Lee, and J. Yook "Wideband Microstrip Patch Antenna With U-Shaped Parasitic Elements" *IEEE transactions on antennas and propagation*, vol. 55, no. 4, April 2007.
- [15] C. K. Wu and K. L. Wong, "Broadband microstrip antenna with directly coupled and gap-coupled parasitic patches", *Microwave Opt. Technol. Lett.* 22, 348–349, Sept. 5, 1999.
- [16] J. Anguera, G. Font, C. Puente, C. Borja, and J. Soler, "Multifrequency microstrip patch antenna using multiple stacked elements," *IEEE Microwave and Wireless Components Lett.*, vol. 13, no. 3, pp. 123-124, March 2003.
- [17] S. I. Sheikh, W. Abu-Al-Saud, and A. B. Numan "Directive Stacked Patch Antenna for UWB Applications" *International Journal of Antennas and Propagation* Volume 2013, pp. 1-6, Nov. 2013. <http://dx.doi.org/10.1155/2013/389571>
- [18] Y. H. Cho., C. Pyo and J. Choi "Gain Enhancement of Microstrip Patch Antenna Using Parasitic Metallic Bar," *IEEE AP-S*, vol. 1, pp. 728 -731, 2003.
- [19] A. Kumar, M. Kumar, "Gain Enhancement in Microstrip Patch Antennas Using Metallic Rings," *American Journal of Engineering Research*, vol. 3, no. 7, pp. 117-124, 2014.
- [20] F. Yang, Y. R. Sami, "Electromagnetic band Gap Structures in Antenna Engineering," Cambridge University Press 2009.
- [21] R. Gonzalo, P. Maagt, and M. Sorolla, "Enhanced Patch-Antenna Performance by Suppressing Surface Waves Using Photonic-Bandgap Substrates," *IEEE Transactions on Microwave Theory and Techniques*, vol. 47, pp. 2131-2138, Nov. 1999.
- [22] H. Boutayeb and T. A. Denidni, "Gain Enhancement of a Microstrip Patch Antenna Using a Cylindrical Electromagnetic Crystal Substrate," *IEEE Transactions On Antennas And Propagation*, vol. 55, no. 11, November 2007.
- [23] A. H. Abdelgwad, T. M. Said, A. M. Gody, "Developing of A Ground Penetrating Radar Antenna for Detecting Water Pollution in Underground Pipelines," *International Journal of Microwaves Applications*, Vol.4, No.1 pp. 1-5, Feb. 2015.
- [24] F. Y. Zulkifli, E. T. Rahardjo, and D. Hartanto, "Radiation properties enhancement of triangular patch microstrip antenna array using hexagonal defected ground structure," *Progress In Electromagnetics Research M*, vol. 5, pp. 101–109, 2008.
- [25] Y. Ge, K. P. Esselle, T. S. Bird, "The use of simple thin partially reflective surfaces with positive reflection phase gradients to design wideband, low-profile EBG resonator antennas," *IEEE Transactions on Antennas and Propagation* vol. 60, pp. 743–750, 2012.
- [26] M. Li and K.-M. Luk, "A low-profile wideband planar antenna," *IEEE Transactions on Antennas and Propagation*, vol. 61, no. 9, pp. 4411–4418, 2013.
- [27] X. Gao, Y. Qi, and Y.-C. Jiao, "Design of multiplate backreflector for a wideband slot antenna," *IEEE Antennas and Wireless Propagation Letters*, vol. 12, pp. 773–776, 2013.
- [28] S. Enoch, G. Tayeb, P. Sabouroux, N. Guérin, P. Vincent, "A metamaterial for directive emission," *Physical Review Letters*, 89, 213902, 2002
- [29] G. Goussetis, A. P. Feresidis, J. C. Vardaxoglou, "Tailoring the AMC and EBG characteristics of periodic metallic arrays printed on grounded dielectric substrate," *IEEE Transactions on Antennas and Propagation*, vol. 54, pp. 82–89, 2006.
- [30] D. N. Elsheakh, M. F. Iskander, E. A. Abdallah, H. A. Elsadek, H. Elhenawy, "Microstrip Array Antenna with new 2D-Electromagnetic band gap shapes to reduce harmonics and mutual coupling," *Progress In Electromagnetics Research C*, vol. 12, pp. 203–213, 2010
- [31] Ahmad H. Abdelgwad, Galal E. Nadim, Tarek M. Said, Amr M. Gody, "Review of Dielectric Permittivity Measurement Techniques," *International Journal of Electronics and Communication Engineering*, Vol. 11, No. 8, pp. 2285-2290, May. 2017.
- [32] Ahmad H. Abdelgwad, Tarek M. Said, "Design of Ground Penetrating Radar Antenna for Detecting Soil Contamination at L-band Frequencies," *International Journal of Microwaves, Optoelectronics and Electromagnetic Applications (JMoe)*, Vol. 16, No. 3, pp. 849-862, Sept. 2017.
- [33] T. I Hugue, K. Hosain, S. Islam, and A. Chowdhury, "Design and Performance Analysis of Microstrip Array Antennas with Optimum Parameters for X-band Applications," *International Journal of Advanced Computer Science and Applications*, vol. 2, no. 4, 2011.
- [34] Ahmad H. Abdelgwad, Tarek M. Said, Amr M. Gody, "Survey on the Utilization of Artificial Intelligence in Remote Sensing," *International Journal of Microwaves Applications (IJMA)*, Vol. 6, No.4, pp. 38-43, Aug. 2017.
- [35] Ahmad H. Abdelgwad, Tarek M. Said, "L-Band Horn Antenna Radiation Enhancement for GPR Applications by Loading a Wire Medium," *Microwave and Optical Technology Letters*, Vol. 59, No. 10, pp. 2558-2563, July 2017.
- [36] Ahmad H. Abdelgwad, Ahmed A. Nashat, "Investigation of Utilizing L-band Horn Antenna in Landmine Detection," *International Journal of Electrical, Computer, Energetic, Electronic and Communication Engineering*, Vol.11, No.7, pp. 728-731, July 2017.
- [37] Ahmad H. Abdelgwad, Tarek M. Said, "Measured Dielectric Permittivity of Contaminated Sandy Soil at Microwave Frequency," *Journal of Microwaves, Optoelectronics and Electromagnetic Applications (JMoe)*, Vol.15, No.2, pp. 51-58, June 2016.
- [38] Ahmad H. Abdelgwad, Tarek M. Said, "Measured Dielectric Permittivity of Chlorinated Drinking Water in the Microwave Frequency Range," *The 15th Mediterranean Microwave Symposium (MMS), IEEE Conference, Italy, Dec. 2015.*
- [39] Ahmad H. Abdelgwad, Tarek M. Said and Amr M. Gody, "A Non-destructive Electromagnetic-based Model for Detecting Water Pollution in Underground Pipelines," *Al-Azhar University Engineering Journal (JAUES)*, Vol. 9, No. 3, pp.1-8, Dec. 2014.
- [40] Ahmad H. Abdelgwad, Tarek M. Said, Amr M. Gody, "Microwave Detection of Water Pollution in Underground Pipelines," *International Journal of Wireless and Microwave Technologies (IJWMT)*, Vol.4, No.3, pp.1-15, Oct. 2014.
- [41] G. Singh and J. Singh, "Comparative Analysis of Microstrip Patch Antenna with Different Feeding Techniques," *International Conference on Recent Advances and Future Trends in Information Technology*, 2012.
- [42] F. S. Fong, H. F. Pues and M. J. wither, "wideband multilayer coaxial-feed Microstrip antenna element," *Electronics letters*, vol 21, pp. 497-498, 1985.
- [43] P. L. Sullivan, and D. H. Schaubert, "Analysis of an Aperture-Coupled Microstrip Antenna," *IEEE Trans. Antennas Propagation*, vol. AP-34, No. 8, pp. 977–984, 1986.
- [44] Y. Gupta, "Stacked Microstrip Patch Antenna with Defected Ground Structures for W-lan and Wimax Applications" Thesis work in Department of Electronics and Communication Engineering, Thapar University, Patiala, June, 2014.
- [45] D. M. Pozar. and B. Kaufman, "Increasing the bandwidth of a Microstrip antenna by proximity coupling," *Electronics letters*, vol 23, no. 8, pp. 368-369, April 1987.