

A Framework for the Design of Green Giga Passive Optical Fiber Access Network in Kuwait

Ali A. Hammadi

Abstract—In this work, a practical study on a commissioned Giga Passive Optical Network (GPON) fiber to the home access network in Kuwait is presented. The work covers the framework of the conceptual design of the deployed Passive Optical Networks (PONs), access network, optical fiber cable network distribution, technologies, and standards. The work also describes methodologies applied by system engineers for design of Optical Network Terminals (ONTs) and Optical Line Terminals (OLTs) transceivers with respect to the distance, operating wavelengths, splitting ratios. The results have demonstrated and justified the limitation of transmission distance of a PON link in Fiber to The Premises (FTTP) to not exceed 20 km. Optical Time Domain Reflector (OTDR) test has been carried for this project to confirm compliance with International Telecommunication Union (ITU) specifications regarding the total length of the deployed optical cable, total loss in dB, and loss per km in dB/km with respect to the operating wavelengths. OTDR test results with traces for segments of implemented fiber network will be provided and discussed.

Keywords—Passive optical networks, fiber to the premises, access network, OTDR.

I. INTRODUCTION

FTTH deployment has evolved over the last 16 years and reached considerable progress in provisioning high speed fiber access network to residential areas. The emergence of bandwidth hungry applications and services has emphasized the need of high speed infrastructure of fiber network to sustain the exponentially growing traffic on the network [1].

PONs have shown great performance compared to copper and wireless access network. PONs have overcome many limitations and shortcomings appeared in conventional access network technologies [2]. PONs, with its different technologies, have proven its capability in providing high speed per user rate, high immunity to electromagnetic interference, high level of security, long distance reach, low cost and low energy consumption. With all these features, PONs have become a premium solution for access network design [1].

FTTx European Council has conducted a study in the last ten years to predict the upstream and downstream traffic growth in access network [3]. One latest study has reported that the 2020 demand estimation for downlink and uplink traffic growth is 8 Gbyte and 3 Gbyte per day respectively [3]. Asian countries have also shown radical improvement in PONs deployment. As reported by FTTH council, 61 million

subscribers in Asia have been serviced with FTTH compared to 5 million of subscribers in Europe [3], [4]. Today, South Korea is one of the worldwide leading countries in the percentage of homes serviced with fibers [3], [4].

In this paper, Section II presents a review on GPON FTTx conceptual design. Optical fiber cable distribution network for green FTTH deployment in Kuwait will be demonstrated in Section III. Section IV describes the methodology for proper selection of transmitters' and receivers' types to meet the requirements of the any design with respect to distance covered and split ratio. Section V demonstrates OTDR test results and traces for a segment of the deployed network. Section VI concludes the paper.

II. GPON DESIGN CONCEPT

A typical conceptual design of a Time Division Multiple Access (TDM) FTTH GPON network is depicted in Fig. 1 [1]. In TDMA design approach, several Optical Network Units (ONU) at subscribers' premises share and compete to gain access to channels/resources in the upstream direction. The OLT switch at the Central Office (CO) can be 20 to 60 km away from the ONUs and is responsible for controlling and managing the channel access among ONUs to avoid collisions. OLTs are also responsible for connecting subscribers to different service providers for data, voice, and video services [4].

The uplink traffic flow from the ONUs to the OLT is a Point to Point (P2P) connection. The downstream traffic flow is in the form of Point to Multi Points (P2MP), originating from the OLT and broadcasted to the ONUs connected within the same PON [5]. The P2P and P2MP nature of traffic forwarding in PONs is a result of the directionality and photonic functionality of the passive optical splitters/couplers that can aggregate and separate the optical signal passively [5]. The bandwidth and resource allocation to the ONUs are managed by the OLT switch and can be performed statically or dynamically [1], [6].

PONs technology has evolved over the years. The ITU along with IEEE has set rules for the purpose of standardization of several PON technologies to meet a range of requirements in terms of transmission speed, splits ratio, distance reach, and protocols [4], [5]. Such standards are Broadband PON (BPON), Ethernet PON (EPON), and Gigabit PON (GPON/XGPON) [5].

In GPON network, the downstream transmission rate from OLT switch towards the ONT is 2.5 Gb/s while the upstream transmission rate is 1.2 Gb/s on each GPON Port [1]. In the downstream, wavelength of 1480-1500 nm is used whereas in

Ali A. Hammadi is with the Electronics Engineering Department, College of Technological Studies, Public Authority of Applied Education and Training (PAAET), Kuwait (e-mail: aa.hammadi@paaet.edu.kw).

the upstream, 1260-1360 nm is used [1].

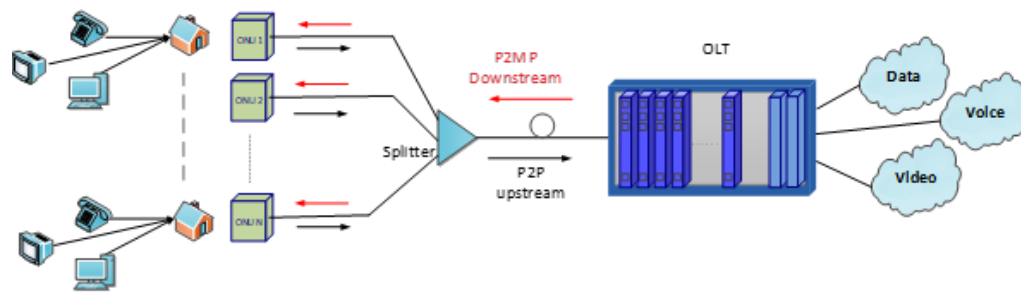

Fig. 1 TDM GPON FTTH Network Design

Three classes of optical transceivers were standardized to define the permitted ranges of attenuation caused mainly by split ratio and distance between the transmitter and receiver. Transceivers' classes with respect to power budgets in PON access networks are as follows [1]:

- A. Class A: 5-20 dB
- B. Class B: 10-25 dB
- C. Class C: 15-30 dB

ONUs at the customers' premises are responsible of delivering triple play services to customers. There are different types of ONUs for medium and large business establishment and multistoried building which differs in the number of ports.

The GPON optical system is capable of transmitting rates up to Giga bits per second. ITU has standardized GPON to provide vendors and service providers with specifications for GPON equipment to be designed and manufactured. Table I summarizes the ITU standardized specifications for GPON service requirements [1].

TABLE I
GPON ACCESS NETWORK CLASSIFICATIONS

Standard	ITU-T G.984
Protocol	Ethernet, ATM, TDM
Data rate	Up to 2.5 Gbps for downlink and up to 1.25 Gbps for uplink
Uplink wavelength	1310 nm
Downlink wavelength	1490 nm and 1550 nm
Distance Reach	20km or up to 60km for Long reach (LR)
Maximum Allowed Splits	32,64, and 128
Power Budget	Class A (5-20 dB) Class B (10-25 dB) Class C (15-30 dB)

III. OPTICAL CABLE DISTRIBUTION NETWORK DESIGN

The network cable distribution design is based on distributed splitting, where a number of different configurations of cascaded passive optical splitters are planned in every route to meet a pre-designed split ratio from the exchange office to end users. The cable distribution network starts from the exchange office and terminates at the end users' premises.

Four categories of fiber cables are considered in the design; Primary Optical feeder cable, Secondary Optical feeder cable, distribution Optical cable and Drop Optical cable [4]. Fig. 2 depicts a real network implementation scenario for the FTTH

project [4]. Different cables are used at different segments of the network. One primary feeder cable as shown in Fig. 2 with 96 strands of single mode fibers are terminated at the CO to 96 Access Module (AM) ports at the OLT switches. The cable is laid using the shortest route passing through all the sub areas. Fig. 2 demonstrates 3 locations of a total of 4 locations along the route where 24 fibers of the primary feeder optical cable are spliced with a 24-core secondary feeder fiber cable. Fig. 3 shows a joint closure box where fiber cores are spliced in one of the intersections along the route. A total of four of 24-core optical cables are jointed at 4 different intersection points to pass through the various main blocks of the sub area. Figs. 3 and 4 show cable termination box for spliced optical cores and manhole with mounted termination box, respectively.

At the block intersection, one fiber from each of the 24 fibers of the secondary optical fiber cable is spliced with 1x4 passive optical splitter. The four outputs of the splitter are spliced with 4 cores of a distribution cable. Each of the fibers of the distribution cable is spliced with 1x8 passive splitter located near 8 subscribers. Drop of cables are laid from each of the 8 outputs of the splitter to connect to an ONT device in the subscriber home. The output of the 1:8 splitters, a drop cable of 1 fiber strand in case of single family premise or 2 strands in case of multistoried building will be laid up to the building.

IV. POWER LOSS AND TRANSCEIVERS' SELECTIONS

The signal power in communication systems is measured in decibels (dB). Loss is introduced in PONs communication systems because of long distance reach, high split ratio, and operating wavelengths used. The choices of the OLT and ONT transceivers are mainly selected based on these factors. Two wavelengths are examined: 1310 nm and 1550 nm. These wavelengths are selected by most of system designers to reduce the effect of hydroxide and water in silica glass from attenuating the signal [1], [4].

Distance reach for real implementation of GPON network between an ONT and OLT switch shall not exceed 20 km. For this study, maximum distance reach is considered as 40 km. As a result, for distances further than 20 km, high signal loss is introduced with low quality of service [4]. Figs. 6 demonstrate that long distance beyond 20 km results in high signal loss and noise. Result from Figs. 5 and 6 justifies the

reason of not exceeding 20km distance reach for a GPON access network to comply with specification enforced by ITU [4]. Figs. 5 and 6 present the minimum required power from

the ONT laser transmitter and OLT to satisfy the receiving sensitivity at the detectors in uplink and downlink directions.

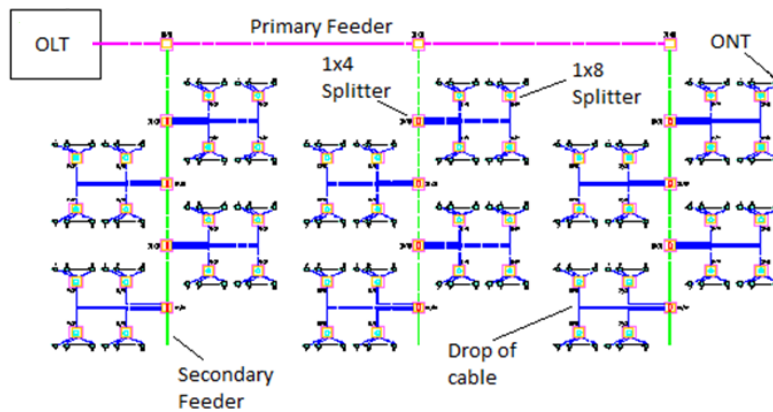

Fig. 2 Fiber Optical Cable Distribution Design



Fig. 3 Splice tray for two jointed optical cables in splice closure



Fig. 4 Mounted splice closure at one of the outside plant intersections

V. OTDR ACCEPTANCE TEST RESULTS

In this section, the results of post installation OTDR test are presented. The OTDR test is carried to ensure that installed optical cables meet the specifications and standards. OTDR test checks the integrity of optical cable laid, finds faults and macro bends, measures length of cable, and verify loss of splices.

OTDR is connected at one end of the fiber cable. OTDR injects optical pulses with a Pulse Width (PW). In our case it is set to 100 ns. The light pulse propagates in the fiber cable and gets reflected to the source when it either reaches the end or when it finds defects. The received results are collected and

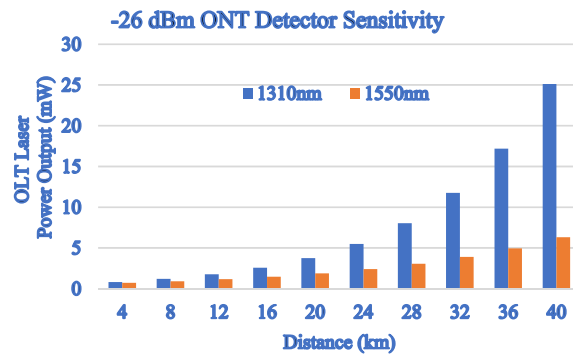

Fig. 5 ONT laser minimum output power for OLT with detection sensitivity of -34 dBm

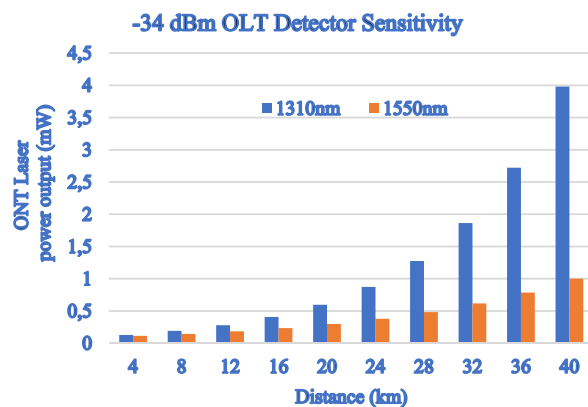

Fig. 6 Required minimum OLT laser power for ONT with receiving sensitivity of -26 dBm

characterized by the OTDR.

In this project, ANDO AQ7250 OTDR is used for testing. Following, results of tested cables used in the commissioned network in this project using ANDO AQ7250 OTDR will be demonstrated. Figures 7-18 are the OTDR results for 12 core single mode fiber cable. The test was carried for 1550 nm wavelength. The cable has a length of 3.225 km with index of refraction of 1.48. The pulse width was set to 100 ns.

OTDR results have provided details about the total length of the optical cable, total loss in dB, and loss per km in dB/km. All tested cores as can be seen in Figs. 7-18 verify that supplier's specifications and standards are met for the 1550 nm. As for 1550 nm, the attenuation loss is 0.25 dB/km [6]. Therefore, the total attenuation loss for the tested cable with total length of 3.225 km should not exceed 0.806 dB when using 1550 nm wavelength. Results in Figs. 7-18 comply with the given specification as average total loss of all tested 12 fiber cores is around 0.65 dB with 0.2 dB loss per km.

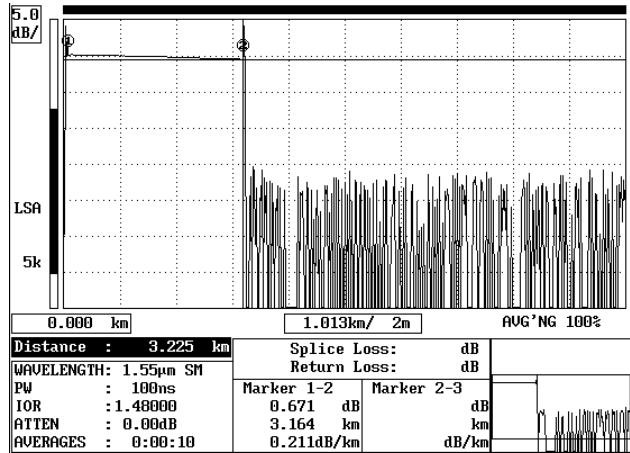

Fig. 9 OTDR trace results for core #3

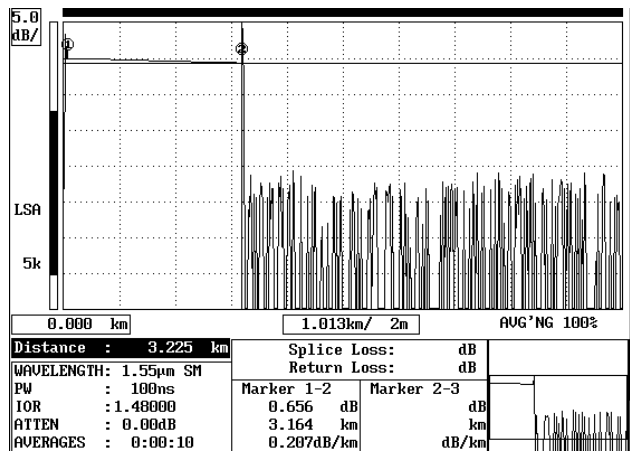

Fig. 10 OTDR trace results for core #4

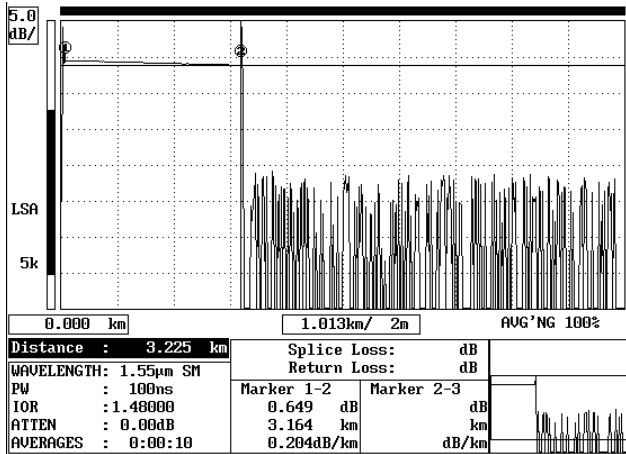

Fig. 7 OTDR trace results for core #1

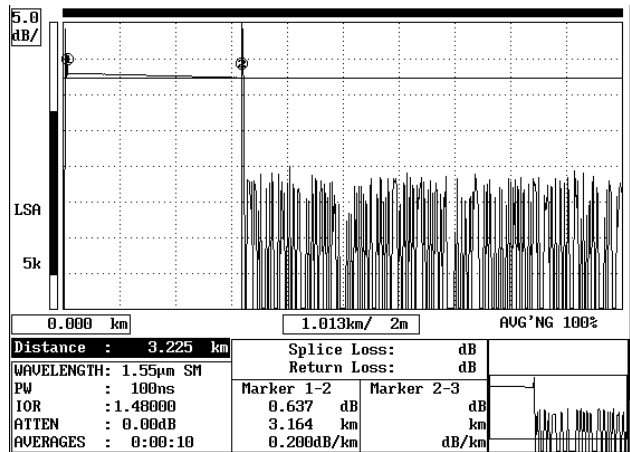

Fig. 11 OTDR trace results for core #5

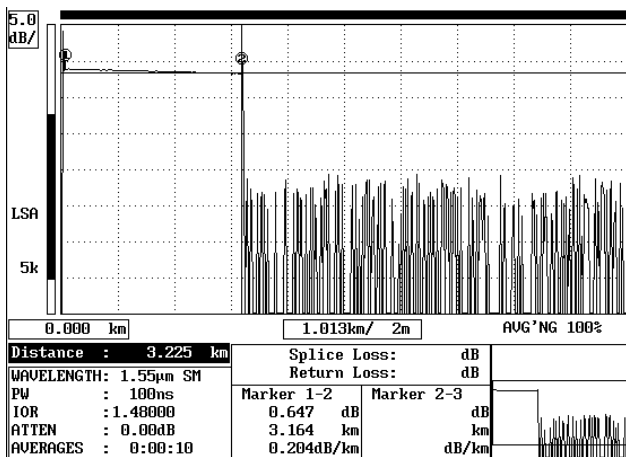

Fig. 8 OTDR trace results for core #2

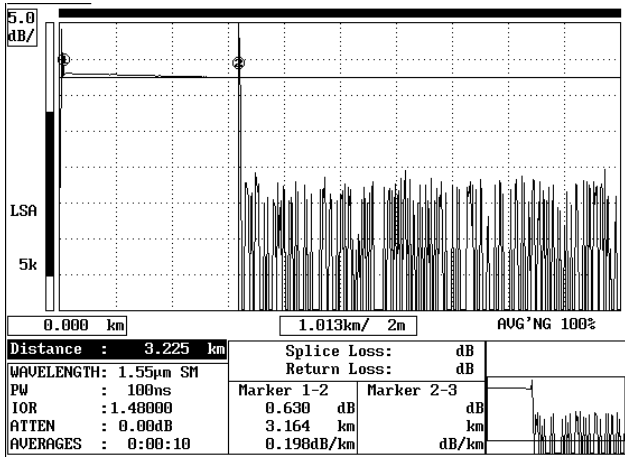

Fig. 12 OTDR trace results for core #6

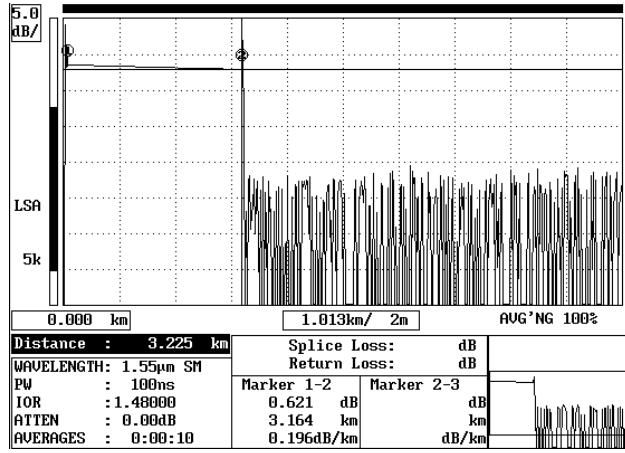

Fig. 15 OTDR trace results for core #9

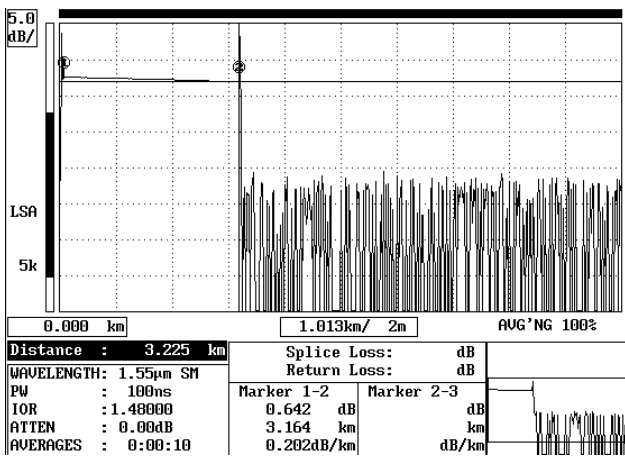

Fig. 13 OTDR trace results for core #7

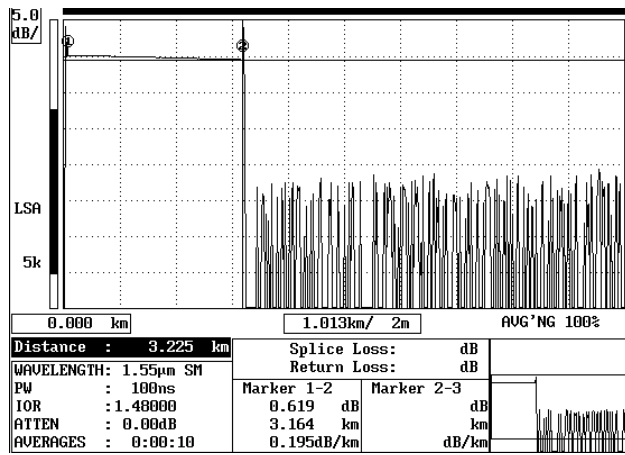

Fig. 16 OTDR trace results for core #10

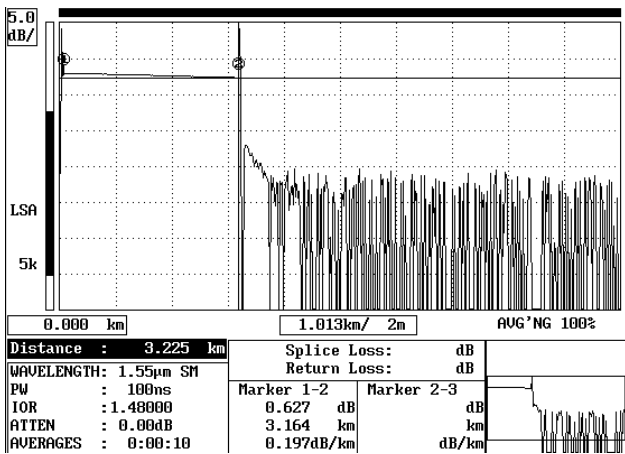

Fig. 14 OTDR trace results for core #8

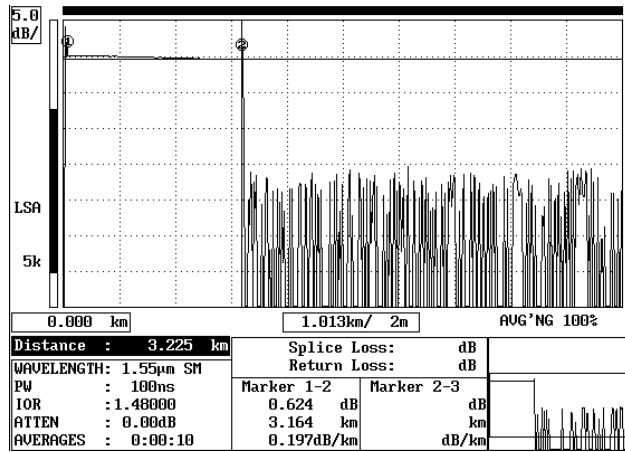

Fig. 17 OTDR trace results for core #11

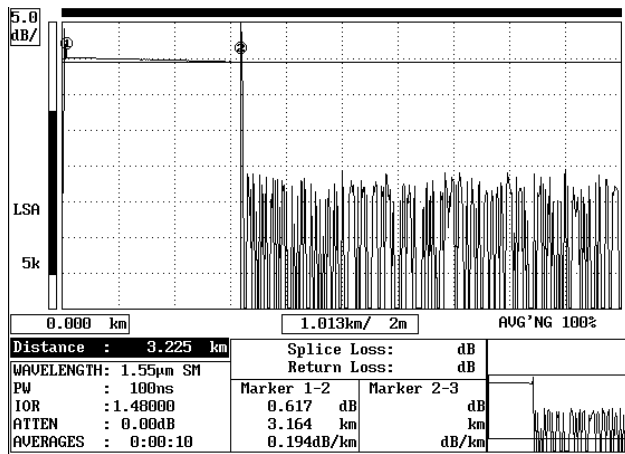

Fig. 18 OTDR trace results for core #12

VI. CONCLUSION

Hungry bandwidth services and applications are continuing to evolve and grow over the years. FTTx networks are of great interest by many countries and service providers to keep pace with the growing demand of bandwidth. FTTH has shown great performance over the last decade in providing high speed interconnection, low deployment cost, low power consumption, high immunity to interference, and high security. FTTH has overcome many limitations of conventional copper technologies in access network. In this paper, a review on GPON conceptual design with optical cable network distribution of planned and deployed network in Kuwait is presented. Concerns about the selection of optical transceivers for ONT and OLT equipment are discussed to define the methodology of transceiver's selection in any PON network. OTDR test traces for a 12-core single mode optical fiber cable are provided to verify compliance with specifications.

ACKNOWLEDGMENT

The author would like to thank M/s Sultan Telecom for their support in providing on-site training for the (FTTH) project based on GPON technology from M/s Alcatel. The project involved supply, installation testing and commissioning of FTTH network for 30,000 premises. The author would like also to thank the Public authority for applied education and training (PAAET) and Kuwait foundation for the advancement of science (KFAS), State of Kuwait for their support.

REFERENCES

- [1] Gerd Keiser. FTTX - Concepts and applications. New Jersey: John Wiley & Sons Ltd.; 2006.
- [2] A. Hammadi, "On the Architecture and Design of Multi-Wavelength Passive Optical Arrayed Waveguide Grating Router", Int. Journal of Engineering Research and Application, Vol. 7, Issue 6, (Part -1) June 2017, pp.95-99.
- [3] The Growth of Fiber to the Home, Website: <http://www.ftthcouncil.eu/> Accessed on: October, 2017
- [4] A. Hammadi, R. Talwar, H. Singh "A Case Study on the Architecture, Design, Implementation and Testing of Fiber to the Home (FTTH)

Green Network in Kuwait, International Journal of Current Engineering and Technology", Vol.7, No.4, pp. 1622-1631, 2017.

- [5] A. Hammadi, "Future PON Data Centre Networks." PhD diss., University of Leeds, 2016.
- [6] ITU-T Recommendations G-652 series: <http://www.itu.int/rec/T-REC-G.652-200506-I/en> Accessed on: October, 2017.