

The Effect of Tool Path Strategy on Surface and Dimension in High Speed Milling

A. Razavykia, A. Esmailzadeh, S. Iranmanesh

Abstract—Many orthopedic implants like proximal humerus cases require lower surface roughness and almost immediate/short lead time surgery. Thus, rapid response from the manufacturer is very crucial. Tool path strategy of milling process has a direct influence on the surface roughness and lead time of medical implant. High-speed milling as promised process would improve the machined surface quality, but conventional or super-abrasive grinding still required which imposes some drawbacks such as additional costs and time. Currently, many CAD/CAM software offers some different tool path strategies to milling free form surfaces. Nevertheless, the users must identify how to choose the strategies according to cutting tool geometry, geometry complexity, and their effects on the machined surface. This study investigates the effect of different tool path strategies for milling a proximal humerus head during finishing operation on stainless steel 316L. Experiments have been performed using MAHO MH700 S vertical milling machine and four machining strategies, namely, spiral outward, spiral inward, and radial as well as zig-zag. In all cases, the obtained surfaces were analyzed in terms of roughness and dimension accuracy compared with those obtained by simulation. The findings provide evidence that surface roughness, dimensional accuracy, and machining time have been affected by the considered tool path strategy.

Keywords—CAD/CAM software, milling, orthopedic implants, tool path strategy.

I. INTRODUCTION

THE primary places that have contact with host organism are the surfaces of orthopedic implants. Acceptable surface quality encourages both stabilization and integration inside the host physiology with regard to wear and corrosion. The difficulties associated with protection of most implants against proteins show that it has prime importance to devote adequate attention to the mentioned problem, as long as both preferment and prevention (repair and replacement of bone) occur with the same importance [1].

Joint prostheses such as hip and proximal humerus regularly wear and generate unpleasant medical concerns that normally solely can be fixed by alternative of the socket joint and ball with a non-natural joint [2]. The joint prostheses are probable to be made from ceramics, metals, and plastics, and be produced with stem, ball and cup.

Generally applied materials consist of stainless steel, titanium, and polyethylene. In order to improve compatibility of the artificial replacement, the friction behavior of the

femoral head-acetabular cup pair plays a crucial role [3].

Implant manufacturers ordinarily intend to maximize the service life of their products, therefore they put high efforts to provide working surfaces that offer the smallest amount of friction and the greatest retention of synovial fluid (a joint's natural lubricant). It is critical to minimize adhesive and abrasive wear in order to produce a surface that is free from irregularities to guarantee the success of an implant [4]. This is essential to identify the adequate milling strategy to produce the surface that meets the requirements which becomes more important when the objectives are to achieve minimum surface roughness, higher dimensional accuracy, and minimize machining costs. Previous studies tried to make efforts to machine free-form surfaces using milling and to optimize the machining procedures [5]-[7]. Surface roughness, dimension accuracy and associated costs were examined to adopt the most efficient tool path strategies which resulted in improvement of computer aided manufacturing (CAM) software productivity.

Instead of traditional milling, during the milling of free-form shapes, the contact between the cutting tool and the machined surface changes constantly. Furthermore, the center of the ball-end tool has zero cutting speed, when it takes part in the machining, process results in material to be drawn instead of to be cut. This condition was examined and it was concluded that the tool path is also responsible for such circumstances [8]. Plenty of investigations can be found about the mentioned phenomena, but the influences of the finishing tool path on the roughness of the machined surface is still unclear, especially with respect to costs and time.

The adequate selection of a tool path to milling a specific geometry can propitiate a reduction on the production costs and improve the surface roughness [9]. In addition, the tool path affects the real machining time as result variable acceleration and deceleration of the cutting tool and the alteration of the tool movement direction during the cutting process [10]. Any commercial CAM software nowadays proposes several possibilities of strategies to introduce the tool path in the domain of the designed part. The regularly used tool path distribution strategies are zig-zag or raster curves, spiral curves, contour curves, space-filling curves, sequential generated curves and radial curves [11], [12].

One of the requisites for having an effective tool path for high speed milling of free form shapes is repeatability efficiency which identifies the tool paths efficiency according to how the paths are similar along the work piece. For instance, using zig-zag tool path, the trajectory many times represent several parallel swipes of a profile. Also, tolerance

A. Razavykia is with the Department of Mechanical and Aerospace Engineering DIMEAS, Politecnico di Torino, CO 10129 Italy (corresponding author, phone: +39-3921348775; e-mail: abbas.razavykia@polito.it).

A. Esmailzadeh and S. Iranmanesh are with Department of Mechanical Engineering, University of Malaya, CO 50603 Malaysia (e-mail: aesmailzadeh2@gmail.com, soudeh1364@yahoo.com).

efficiency is an important condition to increase efficiency of tool path which contains three issues. First, the software must use all extremes of the tolerance range, in order to calculate the fewest possible number of points following the tool path. Second, the distribution of the points must be as homogeneous as possible. Third, the path must guarantee that the geometrical and dimensional tolerances are inside of the designed range. Furthermore, effective tool path requires geometry compatibility that for any free form geometry, concave or convex forms, and the proposed algorithms must ensure compatibility of tool path. In addition, efficiency of tool path is evaluated according to the path trajectory, considering machining and non-machining times includes tool approaches, departures and rapid transversal [13].

The present study investigates the efficiency of the different tool path strategy for finishing milling of complex geometries like spherical joints, which are highly demanded in the medical industries. Therefore, the current work aims to increase the knowledge about the relationship of the surface roughness, tool path strategies and required time for manufacturing of orthopedic implants.

II. MATERIAL AND PROCEDURE

By exchanging knowledge with the implant manufacturer and biomechanics engineers, a proximal humerus was considered with geometry as shown by Fig. 1. With respect to geometry complexity, this part can be a possible option to examine the milling of a proximal humerus head implant. The CAD/CAM software Unigraphics NX 7.5 was used to generate the tool path under the tolerance band of 0.01 mm.

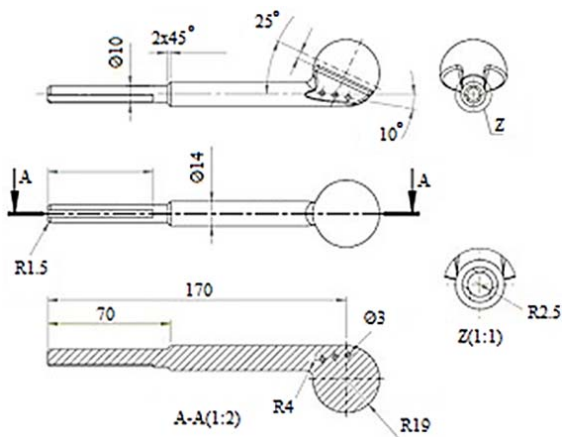

Fig. 1 The proximal humerus geometry

The experiment trials were carried out by using a MAHO MH700 S vertical milling machine equipped with maximum spindle speed 20 to 6300 rpm and feed rate 1 to 4000 mm/min. Four specimens were roughened in the same manner, by three-axis milling, to encourage same surface texture. Each of the four specimens was finished by a different tool path strategy. A carbide ball end-mill of 6 mm of diameter (K-2 Plus) coated with titanium aluminum nitride (TiAlN) was used to perform the finishing operation with a spindle speed of 9000 rpm

(using spindle speed increaser) and the feed rate 450 mm/min. All cases investigated were machined by three-axis milling, down cutting, with coolant. The tool holder was a shrink fit. Stainless steel 316L medical grade was used as a work piece with approximately 230 HB hardness. It is well known that nickel (Ni), chromium (Cr), and manganese (Mn) alloyed materials offer a very good polish ability and photo etching properties, which make them worthy for medical applications requiring a special surface roughness.

Field emission scanning electron microscopy (Supra-35VP, Carl Zeiss, Germany) coupled with energy dispersive spectroscopy (EDS) facility was applied to determine the chemical composition (% by weight) of the stainless steel 316L is given in Table I.

TABLE I
CHEMICAL COMPOSITION OF MATERIAL

Element	C	Mn	Ni	Cr	Mo	S	Si
wt.%	0.025	1.78	13.05	17.53	2.41	0.02	0.8

Spiral path outward was used for the specimen no.1 with step over 0.2 mm. The tool trajectory is only one segment following the geometry in a horizontal way; the tool engages on the material at the beginning and leaves at the end of process. It looks like an offset; however, there is no link between the passes once an offset is formed as illustrated by Fig. 2.

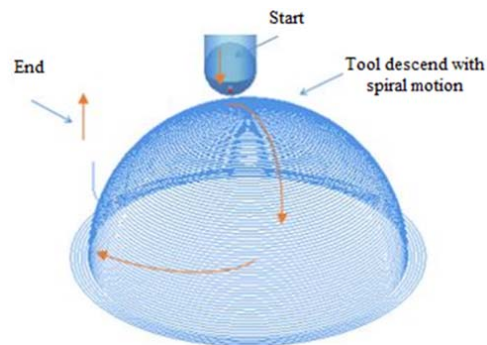

Fig. 2 Tool path simulations; spiral outward

The tool path strategy was the only cutting parameter varied to milling the four specimens. However, after the first investigation for specimen No.1, it was concluded that the step-over could not be kept constant for all different tool path. Therefore, machining time estimated by the CAM software was used to identify the step-over value for each case, in order to keep the same machining time for all part; in the other words, step-over was considered as function of machining time calculated by CAM.

For the specimen no. 2 spiral path inward was chosen with the step over 0.2 mm. The trajectory includes offset passes from the geometry, in a specified level horizontally. Several passes are formed, according to each level (step-over) and connected to each other by a link connection on the surface as shown by Fig. 3.

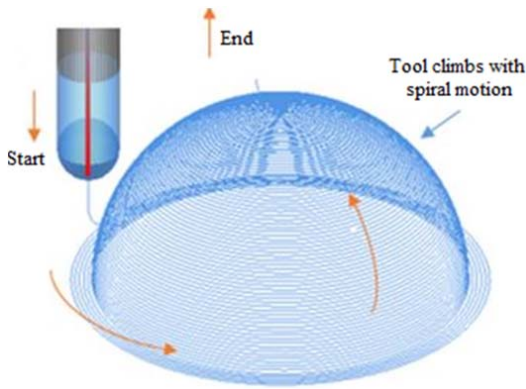

Fig. 3 Tool path simulations; spiral inward

Radial tool path was used for finishing operation of the work-piece no. 3. The paths are calculated vertically on the surface. The center of a circumference and its border are the limits of each path. The border as the beginning of the path (from floor to top) was applied for specimen no. 3. This condition represents different contact between tool and machined surface. The paths were distanced by an angular step over (0.40 degree) and they are linked by movements without removing material (Fig. 4).

Zig-zag tool path (Raster) was applied to work-piece no. 4 with the step-over of 0.2 mm. In this technique, parallel-linear paths are calculated laying on the desired surface. In zig-zag milling, the tool travels only in one direction. The tool has to be lifted and retracted after each cut as shown by Fig. 5.

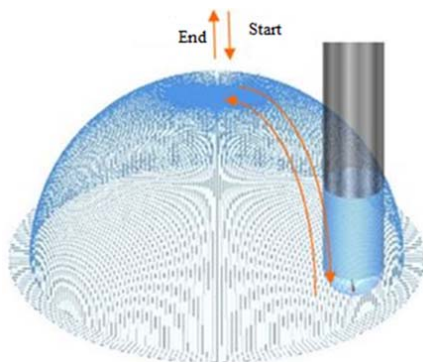

Fig. 4 Tool path simulations; radial

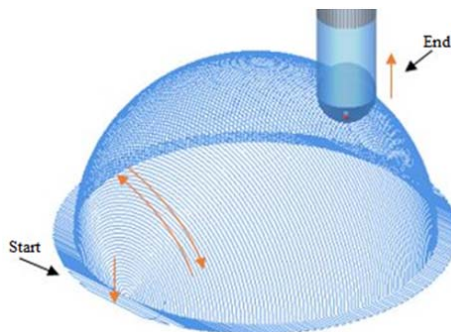

Fig. 5 Tool path simulations of the; zig-zag

The evaluation was carried out according to surface quality after milling and real machining time of each specimens. The roughness of the final surface was measured using a SURFCOM 2000SD3 surface roughness tester. Arithmetical mean roughness (R_a) and ten-point mean roughness (R_z) were measured, perpendicular to the tool paths. Fig. 4 shows the directions of measurement. Three different positions were measured for each specimen and the average value of R_a and R_z were recorded. Dimension accuracy was controlled using a CMM machine (Starrett AV300+) to measure the curvature of final surface in two directions of A and B touching 12 points across the curvatures (Fig. 6).

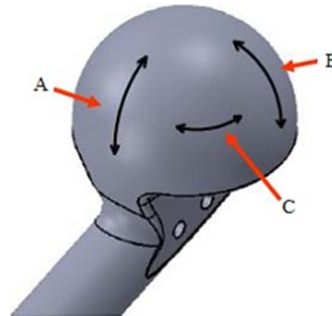

Fig. 6 Three directions of surface roughness and dimensional accuracy measurement

III. RESULTS AND DISCUSSION

The effects of tool path strategy were examined in terms of surface quality, dimension accuracy, and real machining time.

A. Surface Quality

The surface roughness was evaluated considering R_a and R_z as summarized by Table II. It was observed an expressive difference of the roughness among the specimen with respect to tool path strategies. It has been realized that the surface roughness is not only affected by the cutting parameters, but it is also strongly influenced by the tool path strategy. A reasonable relationship among the roughness parameters could be observed, i.e. specimen no. 1 has the lowest value for R_a and R_z using spiral outward whiles work-piece no. 4 applying zig-zag provides the highest values of R_a and R_z . Based on the findings, the spiral inward and zig-zag which impose higher value of roughness are not suitable because they require more time to polish and obtain the desirable surface.

TABLE II
SURFACE ROUGHNESS, R_a AND R_z

Specimen		Direction A	Direction B	Direction C	Average
1	R_a (μm)	1.0433	1.0478	0.9956	1.0289
	R_z (μm)	3.0051	3.7087	3.089	3.2676
2	R_a (μm)	1.1353	1.3287	1.9745	1.4795
	R_z (μm)	4.4464	4.9493	6.8249	5.4069
3	R_a (μm)	1.0546	1.2925	0.8918	1.0796
	R_z (μm)	3.8351	3.9606	2.9852	3.5936
4	R_a (μm)	1.5557	1.3141	1.71	1.5266
	R_z (μm)	5.7428	4.7219	6.4046	5.6231

It can be observed different patterns on the obtained surfaces as shown by Fig. 7 that all the specimens have been machined applying same feed rate and cutting speed but different tool path.

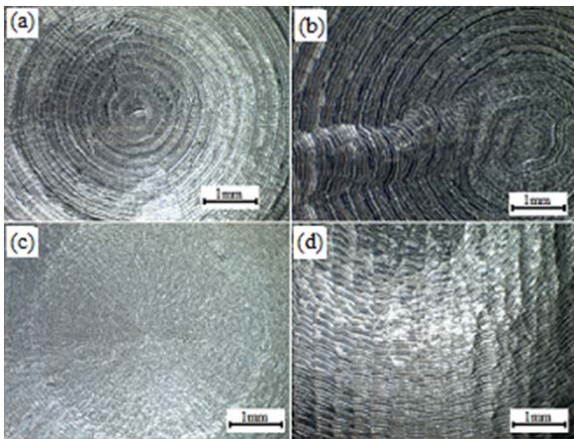

Fig. 7 Machined surface and the effect of tool path on surface texture; (a) spiral outward, (b) spiral inward, (c) radial and (d) zig-zag at 25X magnification

B. Dimensional Accuracy

In order to encourage the accurate dimension control, across each direction A and B (Fig. 6), the measurements have been performed three times, and average values for each direction and specimen are summarized in Fig. 8. The spiral outward applied to work-piece no.1 shows higher deviation.

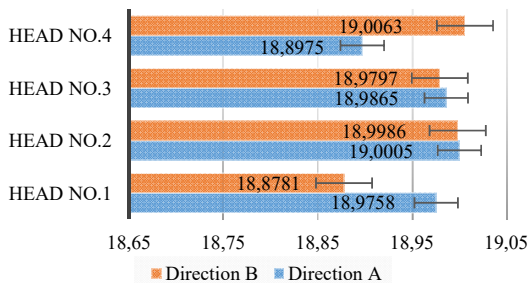

Fig. 8 Dimension measurement for each specimen

C. Real Machining Time

Because of the limitation of the machine-CNC, the time prediction from CAM software to mill a free form shape is not usually achieved, once the CAM does not consider some machine limitations, such as acceleration and deceleration, and CNC block processing time. Commercial CAM software commonly calculates the machining time basically by dividing the entire tool path length by the programmed feed rate. This estimation differs drastically from the real process time because of machine and CNC limitations, the feed rate is not always constant [8]. Therefore, the real machining time was measured for the four tool paths. According to Fig. 9, the real time to machine for the specimens is higher than estimated by the CAM software for all cases. This issue happened due to

limitation on the machine/CNC which cannot be predicted by the CAM software [14].

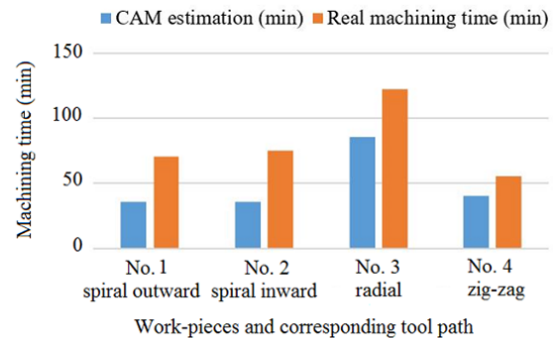

Fig. 9 Machining time for each specimen estimated by CAM software and recorded time during milling with respect to tool path strategy

These results also show that there is no direct association between the machining time and surface quality. For instance, the work-piece no. 4 which is taking the less time to machine provides the worst surface quality, considering all roughness parameters (R_a and R_z). It took longer due to both, the number of engagements and retractions from the material during the machining and because of the higher number of segments to describe the form by the tool path.

IV. CONCLUSION

This work investigates the effect of the tool path strategy on the surface roughness and dimension accuracy for spherical joint implants like proximal humerus head. The evaluation has been performed by considering real machining time according to the tool path strategy with respect to dimensional and surface quality as required by implants application. The results demonstrate that the tool path strategy influences surface roughness, dimensional accuracy, and real machining time. Observations show that the adequate selection of the tool path can save time and cost to meet the final requirements. Therefore, the spiral outward strategy demonstrates better surface roughness and the proper machining time in this study. Besides, the results of the dimensional control for the spiral inward and radial strategies are more acceptable in comparison to the other strategies. The surface roughness and the real machining time are more crucial in implant industries. It is suggested that further investigation could be focused on determining the free form surface machining strategies in term of tool wear analysis, tribological performance in contact zone, and the interrelation of cutting forces, vibration and process kinematics.

REFERENCES

- [1] J. J. Ramsden, D. M. Allen, D. J. Stephenson, J. R. Alcock, G. N. Peggs, G. Fuller, and G. Goch, "The design and manufacture of biomedical surfaces," CIRP ANNA-MANUFAC. TECH., vol. 39, pp. 687-711, 2007.
- [2] A. G. Mamalis, J. J. Ramsden, A. I. Grabchenko, L. A. Lytvynov, V. A. Filipenko and S. N. Lavrynenko, "A novel concept for the manufacture of individual sapphire-metallic hip joint endoprostheses", J Biol. Phys. Chem., vol. 6, pp. 113-117, 2006.

- [3] X. Q. Jiang and L. Blunt, "Morphological assessment of in vivo wear of orthopaedic implants using multiscale wavelets", *Wear*, Vol. 250, pp.217-221, 2001.
- [4] J. H. Dumbleton, "Tribology of natural and artificial joints", Elsevier, vol. 3, 1981.
- [5] R. Baptista and J. A. Simoes, "Three and five axes milling of sculptured surfaces", *J Mater Process Tech.*, vol. 103, pp.398-403, 2000.
- [6] A. M. Abuelnaga and M. A. El-Dardiry, "Optimization methods for metal cutting", *Int. J. Mach. Tool Des. Res.*, vol. 24, pp.11-18, 1984.
- [7] B. White and A. Houshyar, "Quality and optimum parameter selection in metal cutting", *Comput. Ind.*, vol. 20, pp.87-98, 1992.
- [8] A. F. Souza and R. T. Coelho, "Experimental investigation of feed rate limitations on high speed milling aimed at industrial applications", *Int. J. Adv. Manuf. Tech.*, vol. 32, pp.1104-1114, 2007.
- [9] A. M. Ramos, C. Relvas, and J. A. Simoes, "The influence of finishing milling strategies on texture, roughness and dimensional deviations on the machining of complex surfaces", *J. Mater. Process. Tech.*, vol. 136, pp.209-216, 2003.
- [10] M. Monreal, and C. A. Rodriguez, "Influence of tool path strategy on the cycle time of high-speed milling", *Comput. Aided Design*, vol. 35, pp.395-401, 2003.
- [11] B. V. Suresh and N. Raviswaran, "Tool path generation algorithm and 3D tolerance analysis for free-form surfaces", *J. Sci. Tech.*, vol. 4, pp.23-30, 2006.
- [12] D. Misra, V. Sundararajan, and P. K. Wright, "Zig-zag tool path generation for sculptured surface", *Geometric and Algorithmic Aspects of Computer-Aided Design and Manufacturing*, p.265, 2005.
- [13] A. Souza, A. Diniz, A. Rodrigues, and R. Coelho, "Investigating the cutting phenomena in free-form milling using a ball-end cutting tool for die and mold manufacturing", *J. Adv. Manuf. Tech.*, 2014.
- [14] R. Coelho, A. de Souza, A. Roger, A. Rigatti, and A. de Lima Ribeiro, "Mechanistic approach to predict real machining time for milling free-form geometries applying high feed rate", *J Adv Manuf Tech.*, vol. 46, pp. 1103-1111, 2010.

A. Razavykia was born in Hamedan, Iran in 1985. He has received his BSc in the field of Industrial Engineering (Industrial Technology) in 2009 from QIAU, Iran. He has worked as Manufacturing and Process Engineer and Project Manager in several companies. After gaining some experience in industry, he started his post education in the field of Mechanical Engineering (Advanced Manufacturing Engineering) at UTM, and received his MSc in 2014. He has started his PhD in 2015 at Politecnico di Torino, Italy. His interesting research areas are Mechanical Engineering, Production Planning and Control, Tribology, Optimization and Simulation and Modeling.

Dr. Esmailzadeh is dynamic, innovative, performance driven and highly motivated mechanical and sustainable energy engineer with 7+ years of successful experience in the industry and academic. He possesses a sound knowledge in both design and manufacturing sides of mechanical and energy related issues including product design, product development, process planning, energy management, optimization and numerical simulation. I have a proven track record of successfully done some manufacturing and energy management projects and computational fluid dynamics (CFD) simulation with extremely satisfying results under closed deadlines.

Dr. Iranmanesh is highly motivated mechanical engineer seeking to grow in manufacturing and optimize the thermal energy application efficiency. Experienced in various engineering processes, thermal energy systems and material science. These including optimization modern and convectional machining process, energy system analysis and optimize, synthesis and preparation of nano-fluids for both field (energy and manufacturing process (EDM)). Ability to work with CAD/CAM/CAE/CFD software and create technical documents and drawings. Specific skills are including conduct research into the feasibility, design, operation and performance of mechanisms, components and systems, Investigate mechanical failures or unexpected maintenance problems.