

Analysis and Design of Inductive Power Transfer Systems for Automotive Battery Charging Applications

Wahab Ali Shah, Junjia He

Abstract—Transferring electrical power without any wiring has been a dream since late 19th century. There were some advances in this area as to know more about microwave systems. However, this subject has recently become very attractive due to their practical systems. There are low power applications such as charging the batteries of contactless tooth brushes or implanted devices, and higher power applications such as charging the batteries of electrical automobiles or buses. In the first group of applications operating frequencies are in microwave range while the frequency is lower in high power applications. In the latter, the concept is also called inductive power transfer. The aim of the paper is to have an overview of the inductive power transfer for electrical vehicles with a special concentration on coil design and power converter simulation for static charging. Coil design is very important for an efficient and safe power transfer. Coil design is one of the most critical tasks. Power converters are used in both side of the system. The converter on the primary side is used to generate a high frequency voltage to excite the primary coil. The purpose of the converter in the secondary is to rectify the voltage transferred from the primary to charge the battery. In this paper, an inductive power transfer system is studied. Inductive power transfer is a promising technology with several possible applications. Operation principles of these systems are explained, and components of the system are described. Finally, a single phase 2 kW system was simulated and results were presented. The work presented in this paper is just an introduction to the concept. A reformed compensation network based on traditional inductor-capacitor-inductor (LCL) topology is proposed to realize robust reaction to large coupling variation that is common in dynamic wireless charging application. In the future, this type compensation should be studied. Also, comparison of different compensation topologies should be done for the same power level.

Keywords—Coil design, contactless charging, electrical automobiles, inductive power transfer, operating frequency.

I. INTRODUCTION

THE growing number of energy consuming devices, together with the increasing demand for energy, has led to an energy crisis in the world today. Furthermore, some petroleum products including liquefied petroleum gas and natural compressed gas has, for several decades, remained the main sources of energy for transportation. Because of the continuous carbon dioxide emission from the use of these energy sources, there is a steady increase in the global warming.

Wahab Ali Shah (PhD Candidate) is with the School of Electrical & Electronic Engineering (SEEE) in Huazhong University of Science and Technology (HUST), China (phone: +8615549424656, e-mail: 2682098142@qq.com).

Junjia He (Professor) is with the SEEE in HUST, (e-mail: 228167386@qq.com).

This has compelled engineers and scientists together with researchers to find an accurate and sustainable alternate solution to these natural energy sources. Due to this effect, a lot of energy technologies are being developed and applied to avoid global warming from gas exhaustion and to reduce energy cost. The advent and electric vehicles (EVs) integration has been received by all as a present solution to the depleting assets (petroleum), which are mainly used in the automotive applications. The trend in the development of these advanced energy systems can be analyzed carefully.

The concept of EVs was developed, through initiation of the “HEV” stands for hybrid EVs. Shortly afterwards, engineers took another step forward, with the invention of plug-in hybrid (PHEVs) or connect HEV’s. Nonetheless, PHEVs were accepted, but the applications were associated with a lot of disadvantages. It was enhanced with the linking cable and charger (plug-in) as well as galvanic isolation of onboard electronics. Also, it was difficult to carry the charger, given its size and weight. This system was associated with heavier problems, like operating it in rain and snow, since water is also a conductor that could cause the short circuiting of the system. To avoid these numerous setbacks in the PHEV, many technologies have been advanced, to produce pure EV. Pure EV has decent qualities. Unlike the conventional transport system, an EV enhances smoke free transport; as a result, this describes a successful clarification to the unpleasant atmosphere impact (toxic smoke).

Pure EVs have additional advantages. They can be powered by charging wirelessly, and it does not depend upon weather conditions (good or bad) along with no connecting wires or plugs in comparison with PHEVs. EV also has limitations. Batteries used to store energy are heavy and expensive. Time is needed to fully charge the batteries, and the driving range is still limited. Also, batteries need to be replaced in a few years. A recent topic of interest for EVs is wireless charging. It is also called inductive charging technology (IPT). Through IPT, it is possible to charge batteries in shorter time without any physical correction. IPT can be used for static and dynamic charging. Although, it is a safe technology, there are issues to address such as alignment of coils, foreign object detection, and object detection.

II. LITERATURE REVIEW

The 50s were famous by the development of space study, whereas the end of the 20th century was well-known by the advancement of PCs and the start of the information age [3].

Clearly, one of the symbols of the start of the 21st century is the quick evolution of wireless communication and flexibility. One cannot see life nowadays without mobile phones, portable PCs, worldwide positioning systems, etc. In contrast to wireless information exchange, wireless power is an old idea of Nikola Tesla tested in the late 1800s [3]. He was considering it as a distinct option for building the electric grid. He designed the first systems and built a tower to test his system. However, funding was not enough and the project was suspended. The concept became a subject of interest again after the Second World War with the advent of microwave systems [3].

William et al. demonstrated the first microwave wireless power transmission system [1]. History states that wireless power was never acknowledged at a customer level, and the idea was nearly overlooked. In 2007, researchers at MIT issued an official statement representing how to transfer power wirelessly using magnetic resonance and introduced results of transfer distances up to 2 or 3 m. Then, interest in this technology has boomed and the reason is clear. Wireless power might be used in a wide-ranging of applications stretching from mobile devices cell phones, tablets, laptops, and sensors to plug-in cars, transports [3].

Estimations demonstrate that wireless power could be a billion-dollar industry within the coming 10 years. In short, inductive power transfer also called wireless power transfer. It is the transmission of electrical energy from the electrical source to electrical load without any connection. This technology is very valuable in those situations where uses of interconnecting wires are difficult, hazardous/dangerous, or almost unmanageable. IPT can be utilized as a part of numerous applications like hybrid electrical vehicle, medical sensor, laptop charger etc. [3].

The first research project that looked at inductive charging with some details is the U.C Berkley PATH program in the late 1970s [3]. The system has a limitation of a frequency of 100 Hz. The system functions as a spring board to a preliminary charging system of frequencies that is very high. Consequently, the system detuned and operated when placed next to the ferromagnetic chassis of the vehicle [3]. Thereafter and more recently, a multipath receiver pickup was presented for inductive charging. Many other publications have been made on pad design (for vehicle charging). However, they have not provided a thorough overall design process [3]. The limitation here is that the system efficiency is 85% with power level around 60 kW, and researchers have started to experiment in motion charging for light duty vehicles, though the research is still at its early stage as the full hardware solutions for the system are yet to be implemented [1].

National University of Kyoto, Japan has repeatedly conducted research on Micro Power Transfer (MPT) [2]. In 2000, researchers in Kyoto University established a system for MPT charging of EV's and they obtained 76% efficiency. Volvo technologies Japan and Nilion Dengyo Kosaku companies developed 10-kW retina array, which has receiving capability 3.2 kW/m² at distance of 4 m, and obtained 84% efficiency. The MPT systems were shown by the above technologies to have the capabilities of transmitting power to

long distance, but with the increased-cost disadvantage, and large antenna size. Likewise, high power applications (transmission through microwaves) have no security for human beings [2]. However, available solutions exist to overcome this shortcoming of cost, along with antenna size [3]. The study was related to the design techniques for magnetic coupler, mechanisms for control, detection-algorithms, compensation topologies, as well as safety issues (radiation). Amongst the several issues addressed above, researchers concluded on the design of magnetic coupler and compensation circuits. Loosely coupled transformer formed the magnetic couplers of 5 WPT chargers [1]. They have their primary and secondary coils linked across a relatively large air gap in a fixed charging system. Having a higher efficiency and tolerance to misalignment with maximum dimensions is always preferable. In some other kinds of couplers, the geometries along with configurations have been proposed by researchers [3]. Circular design has been well researched and optimized.

III. COMPENSATION TOPOLOGIES

An air cored transformer results in low efficiency, because of large leakage inductances in both primary and secondary windings. There is a smart method to solve the problem presented here, by using capacitors in order to compensate the reactive current. We can use shunt and series compensation in power system, while capacitive compensation is applied to power system for reactive compensation [4].

1. In the case of shunt compensation, this leads to an increase in power transfer ability and reduction in the reactive voltage drop across line.
2. In the case of series compensation, the maximum power transfer capability of the line is better, because of partial compensation of series inductance, and reduction in load angle results in enhancement of system stability [4]. In order to overcome system losses, capacitors can be connected in series and parallel to both coils.

The secondary capacitance is selected as the first step. This is done in such way in order to compensate the secondary leakage inductance, and mutual inductance. This type of compensation leads to the improvement of power transferred to the load. The primary capacitance is then selected such that, it considers the inductance of the complete circuit [4]. Primary capacitances selected to compensate just the self-inductance of the primary and the inductances of the whole circuit are present. However, it is a better choice to perform compensation for the entire circuit, so as to the input power factor becomes unity [4].

There are two different ways to connect the compensation capacitors in series and parallel to both sides of inductors. Due to these connections, there exist four different topologies known as series-series (SS), series-parallel (SP), PS parallel-series (PS), and parallel-parallel (PP) [3].

A. Coil Design

IPT system design is a complicated process. Although there are some papers describing design methodologies, there is not a generally accepted design process yet. Several studies have been carried out in order to select the most appropriate

compensation topology for ICPT systems, depending on the application and taking into account the stability of the configuration [5]. However, these studies do not include a general design procedure to select the optimal number of coils

and sections of the windings for a desired transferred power. Two design procedures are presented, but there remain many design decisions that depend on the actual case and the experience of the designer [6].

TABLE I
FOUR DIFFERENT TOPOLOGIES

Topology	Acts like sources	Independent of changes	Power factor small distance	Total impedance at resonant	Efficiency
SS	Current	C_2	Low	Low	very high
SP	Voltage	C_2	Low	Low	medium
PS	Voltage	C_2	high	high	medium
PP	Current	C_1	very high	high	high

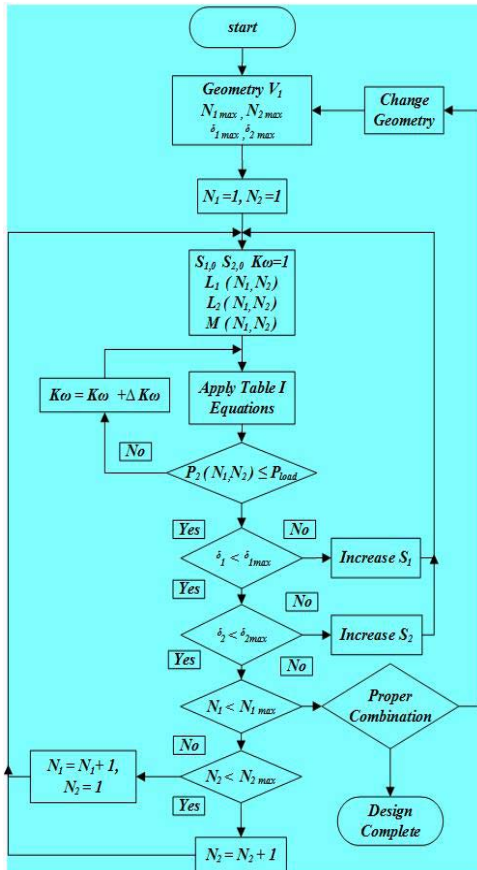

Fig. 1 Flow chart

An optimum design methodology that seems to be working well is given in [7]. The method described in this paper is an iterative one, which yields a possible solution at each step. Then, the optimum solution is found among the set of solutions. The methodology given in the mentioned paper is based on the algorithm given in flow chart. It starts with the selection of coil geometry, maximum current density for the coils, and maximum number of turns allowed.

In the iteration process, first, the number of turns for each coil is assumed to be 1, and some initial values are assigned to coil cross-section areas. Also, a frequency factor which determines the operation frequency is started at 1. In the first step, inductance values are calculated for the given initial

values. Based on current, voltage, power values and quality factors are calculated for the compensation topology of choice.

If the load power is less than the targeted value, frequency is increased and calculations are repeated for the same coil size. This iteration is repeated until the desired power level is reached. Once the power level is reached, the current density values of the coils are checked to see if this is an acceptable operation point. If the current density is above the defined limit at a coil, corresponding cross-section area is increased and the iteration is repeated.

IV. RESULTS AND DISCUSSION

The iterative technique described above was tested in computer via MATLAB software. Maximum number of turns was defined to be 30 and 10 for the primary and secondary, respectively. For each pair of turn numbers, a solution was found iteratively, starting from an initial cross section and by changing the frequency. Figs. 3-7 show the results.

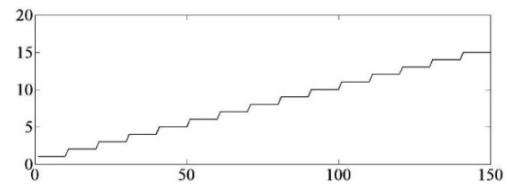

Fig. 2 Turn number variation for the primary at each step

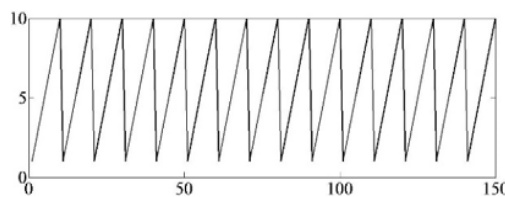

Fig. 3 Turn number variation for the secondary at each step

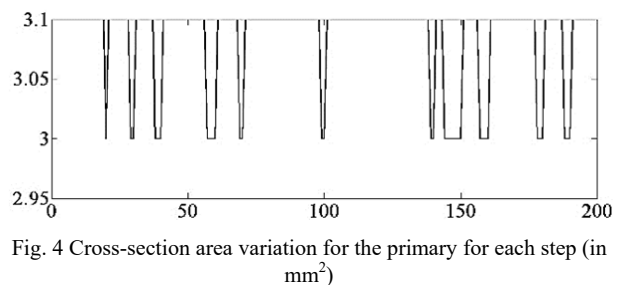

Fig. 4 Cross-section area variation for the primary for each step (in mm²)

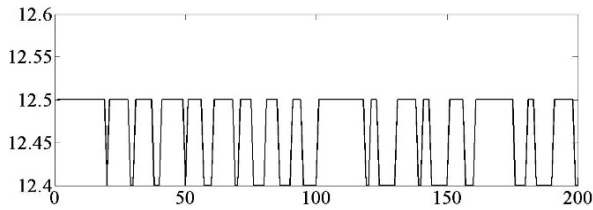

Fig. 5 Cross-section area variation for the secondary for each step (in mm^2)

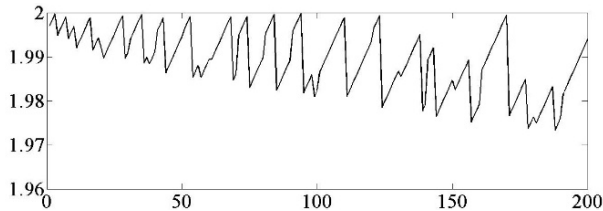

Fig. 6 Output power variation for each step (in kW)

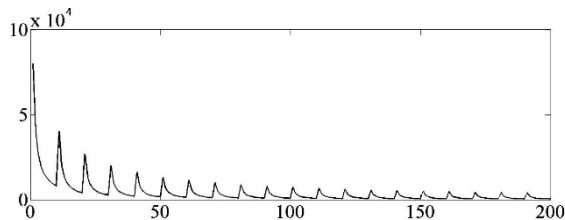

Fig. 7 Variation of resonance frequency in kHz

Results show that the technique produces possible solution for each set of turn numbers. A true solution should be selected among these results to build the real system. However, although a low switching frequency is targeted, it seems that it is not attained due to some fault in the equations. Therefore, the data given in [7] will be used in the remaining of the paper.

V. DESIGN OF A 2-KW SYSTEM

The topology is selected as rectangular coil structure with a maximum frequency of 20 kHz. When the methodology presented applied, the optimum solution was obtained with S-S compensation, as shown in Table II. The coil dimensions were found to be $a_1=0.4$ m, $b_1=0.8$ m, and $h=0.15$ m by using MATLAB Code (coil parameters given in Table II).

A. Simulation of the System

The operation of single-phase full bridge DC-DC converter is described, and the simulation results obtained by MATLAB\Simulink were presented. The full wave bridge inverter includes two arms, two switches, and anti-parallel (freewheeling) diodes as shown in Fig. 8. These are used to provide paths for the reverse currents. The switches are

represented here by name of T_1 , T_2 , T_3 , and T_4 , respectively. For each branch, the upper and lower switches are turned on and off alternating, with a brief dead time in between the transitions. There is 180° phase shift between the two legs which means diagonal switches conduct together to apply square wave voltage across the load [3].

TABLE II
COIL PARAMETERS

Parameters (Units)	Values
N_1	27
N_2	7
V_1 (V)	50
S_1 (mm^2)	2.5
S_2 (mm^2)	10
R_1 (Ω)	0.4
R_2 (Ω)	0.02
L_1 (H)	0.0146×10^3
L_2 (H)	0.0060×10^3
P_L	2000
F_0 (kHz)	19.8
η (%)	95
V_{C1} (V)	2019
V_{C2} (V)	305
I_p (A)	10.5
I_s (A)	40
C_2 (μF)	0.0043×10^3
Q_p	10.7
Q_s	6.1

VI. SIMULATED CIRCUIT AND RESULT

The circuit used in the simulations is shown in Fig. 8. The circuit parameters are as follows: $L_1=1.46$ mH, $L_2=61$ μH , $C_1=43.7$ nF, $C_2=1.05$ nF. These parameters are part of those given in Table II. The switching frequency is 20 kHz, which is equal to the resonance frequency of the LC circuits; the primary capacitor is in resonance with the inductance of the transformer. The transformer is defined as a coupled inductor with the inductance parameters given above. The coupling factor is taken as 0.5.

The square wave voltage generated by the inverter is shown in Figs. 9-12. The frequency of this voltage is 20 kHz, which is the resonance frequency of the primary. In Fig. 10, the currents in the primary and secondary are shown. As seen in the figure, the currents are nearly sinusoidal at the resonance frequency of 20 kHz. In Fig. 11, (a) primary capacitor voltage is shown, (b) the secondary side capacitor is given. As expected, the voltages can increase significantly meaning special capacitors are required for this application. Finally, output voltage is shown in Fig. 12. The load of this circuit can be replaced with a battery charging system to simulate the real one.

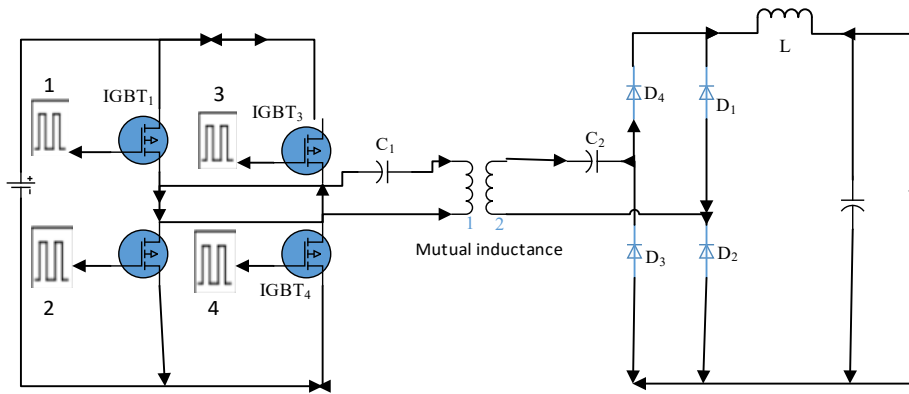

Fig. 8 Simulated circuit

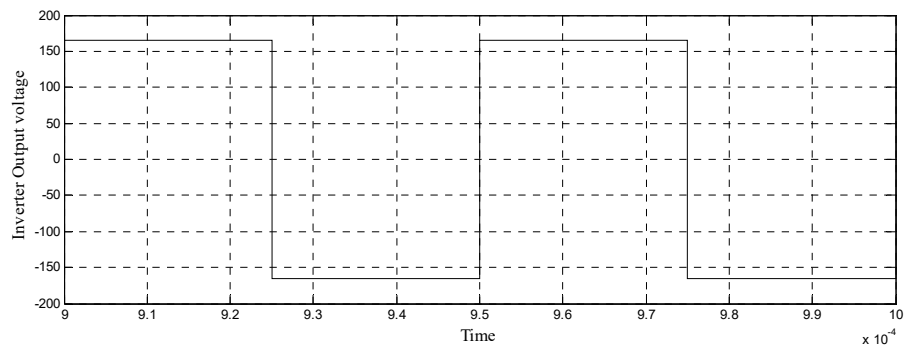

Fig. 9 Inverter output voltage

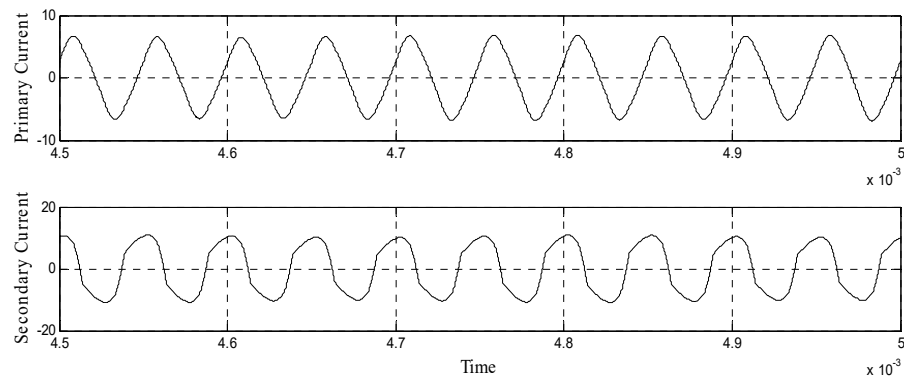
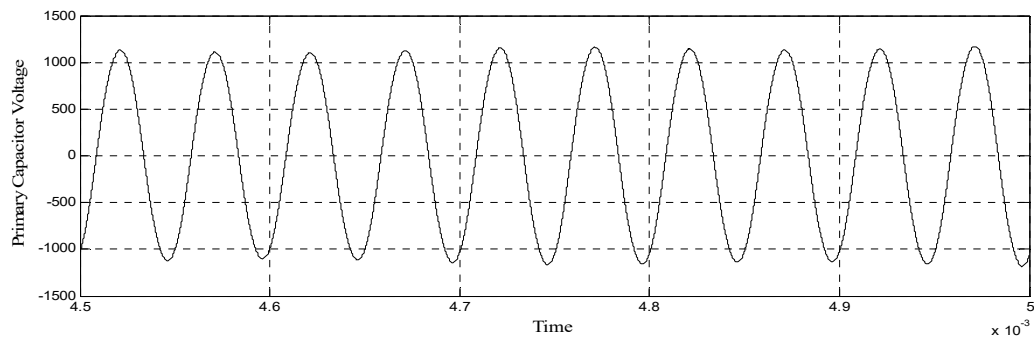
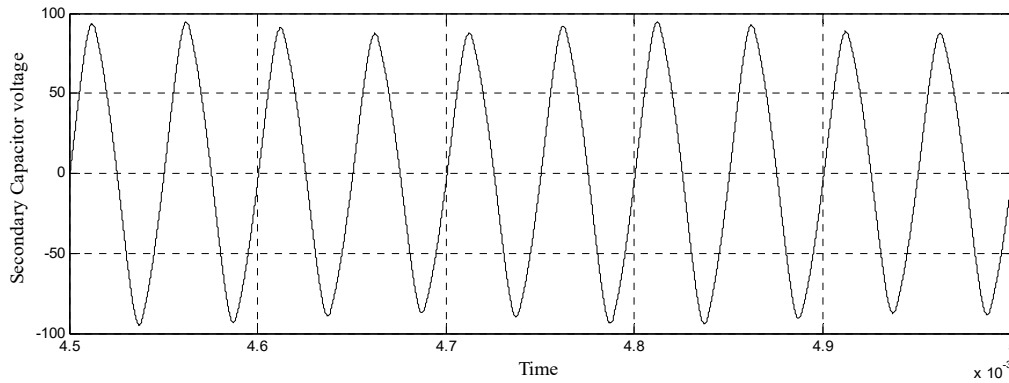

Fig. 10 Primary and secondary currents



(a) Primary voltage



(b) Secondary voltage

Fig. 11 Capacitor voltages

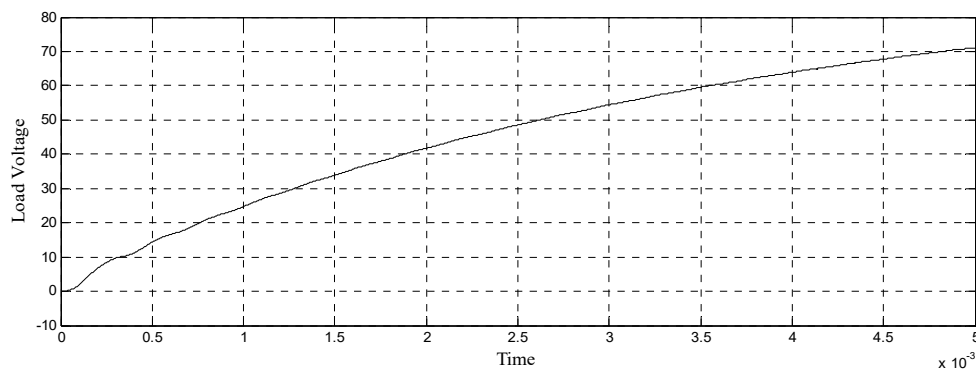

Fig. 12 Load voltage

VII. CONCLUSION AND SUGGESTION FOR FUTURE WORK

In IPT systems, power is transferred between the coils of the system. The coils are not around the same core, and there is a distance between the coils making the system a loose coupled one. In order to transfer the power efficiently resonance concept should be utilized. There are four classical topologies and also the new proposed ones such as LCL topology. The one presented here uses series-series compensation topology, which is adequate for battery charging applications. However, the results show that capacitor voltages increase tremendously, and this requires special capacitors. Therefore, LCL topology needs to be utilized instead of the classical series one.

Another subject that should be studied is the control of the system. The system was run on open-loop control, but it needs to be improved. There are different control topologies presented in the literature and double-side control seems to be very promising. Also, hybrid control algorithms, taking care of the duty cycle control and zero phase angle control at the same time can be very interesting. There are already published papers investigating this issue. One final possibility for the future is investigating the operation of different converter topologies, especially multilevel converter topologies as they could provide a good power factor and high powers necessary for some applications.

ACKNOWLEDGMENT

The author would like to thanks Professor Junjia He for his linguistic support, also especially my parents who always supported and encouraged me in all aspects of my life.

REFERENCES

- [1] Wu, H. H., Golchrist, A., Sealy, K. D. & Bronson, D. (2012). "A high efficiency 5kW inductive charger for EV using dual side control". *IEEE Transactions on Industrial Informatics*, + (3), 585-595.
- [2] Kalwar, K. A., Amir, M., & Mekhilaf, S. (2015). "Inductively coupled power transfer (ICPT) for electric vehicle charging-A review". *Renewable and Sustainable Energy Reviews*, 47, 462-475.
- [3] Li, S., & Mi, C. C. (2015). "Wireless power transfer for electric vehicle applications". *IEEE journal of emerging and selected topics in power electronics*, 3(1), 4-17.
- [4] Hingorani, N. G., & Gyugyi, L. (2000). "Understanding FACTS: concepts and technology of flexible AC transmission systems". United States: Wiley-IEEE press
- [5] Chao, Y. H., Sheih, J. J., Pan, C. T., & Shen, W. C. (2007). "A closed-form oriented compensator analysis for series-parallel loosely coupled inductive power transfer systems". In *Proceedings of IEEE International Conference on Power Electronics Specialists Conference* (pp.1215-1220). Orlando: IEEE.
- [6] Lee, B. S. & Han, K.H. (2005). "Modeling and analysis of IPT system used for PRT". In *Proceedings of IEEE International Conference on Electric Machines and Systems* (pp. 839-842). Perth: IEEE.
- [7] Sallán, J., Villa, J. L., Llombart, A., & Sanz, J. F. (2009). "Optimal design of ICPT systems applied to electric vehicle battery charge". *IEEE Transactions on Industrial Electronics*, 56(6), 2140-2149.

Wahab Ali Shah is currently pursuing Doctoral degree program in School of Electrical & Electronic Engineering (SEEE) in Huazhong University of Science and Technology (HUST). Research interests include wireless power transmission, lightning discharge and high voltage engineering.

Junjia He received B.Eng. and Ph.D. degree in Electrical & Power Engineering from Huazhong University of Science & Technology in 1990 % 1995, respectively. He is a Professor at School of Electrical & Electronic Engineering (SEEE) in Huazhong University of Science and Technology (HUST) since 2001. His research interesting is electromagnetic transients in power system, high voltage apparatus. He focuses on the fields such as electromagnetic transient simulation by EMTP, EMTDC/PSCAD, lightning discharge and its attachment process, arc phenomena, HVDC circuit breaker.