

Summing ANFIS PID Control of Passenger Seat Vibrations in Active Quarter Car Model

Devdutt

Abstract—In this paper, passenger seat vibration control of an active quarter car model under random road excitations is considered. The designed ANFIS and Summing ANFIS PID controllers are assembled in primary suspension system of quarter car model. Simulation work is performed in time and frequency domain to obtain passenger seat acceleration and displacement responses. Simulation results show that Summing ANFIS PID based controller is highly suitable to suppress the road induced vibrations in quarter car model to achieve desired passenger ride comfort and safety compared to ANFIS and passive system.

Keywords—Quarter car model, Active suspension system, Summing ANFIS PID controller, Passenger ride comfort.

I. INTRODUCTION

VEHICLE ride comfort and handling are two main deciding factors in suspension system design and development. Suspension system must suppress the vertically transmitted vibrations in vehicles to achieve desired ride comfort and handling. Depending on the type of assembled components, a suspension system can be classified as passive, semi-active and active type. Passive suspension system is mostly used in vehicles due to its low cost compared to semi-active and active type. It is assembled with spring and damper having fixed stiffness and damping values decided by the designers. It is effective only in certain frequency range in terms of controlling road induced vibrations, resulting into low performance related to passenger and vehicle body safety during running conditions. Semi-active suspension system is integrated with magneto-rheological or electro-rheological dampers to provide variable damping in vehicle suspension [1], [2]. But design of controllers for handling the working of these dampers is complicated task. Active suspension systems are capable of providing best performance in terms of ride comfort and safety of travelling passengers compared to passive and semi-active type [3]-[5]. The working of assembled actuators and sensors in active suspension system provide desired damping force in vehicles resulting into vibration control in high frequency range. Thus, active suspension systems are attractive choice for vehicle industries and researchers due to its above mentioned various advantages.

In past, various control techniques have been developed and employed in active quarter car system to achieve enhanced ride comfort and vehicle handling issues by supplying

appropriate control force in suspension system. Huang and Lian [6] used fuzzy and neural network control scheme to design hybrid controller. Rao and Prahlad [7] designed a tunable fuzzy controller for application in an active quarter car suspension system. Kuo and Li [8] proposed genetic algorithm based optimized fuzzy proportional integral/proportional derivative controller. Sharkawy [9] implemented adaptive fuzzy controller in active suspension system. Yildirim and Eski [10] applied neural network control in test rig of active quarter car model to achieve high ride quality. Lin et al. [11] implemented a hybrid self-organizing fuzzy controller and radial basis function neural network controller (HSFRBNC) based controller in active quarter car model. Li et al. [12] used a reliable fuzzy H_∞ controller in active suspension system of quarter car model. Kothandaraman and Ponnusamy [13] tuned the parameters of ANFIS controller using Particle Swarm Optimization (PSO) technique. Devdutt and Aggarwal [14] implemented a hybrid fuzzy – PID controller with coupled rules in an active quarter car model.

In present paper, an active quarter car model with three degrees of freedom is taken to improve the passenger ride comfort and safety during travelling period. The designed Summing ANFIS PID (SANFISPID) controller is the combination of ANFIS and PID controller and applied in the primary suspension of an active quarter car model. The passenger seat vibration responses are studied in terms of acceleration and displacement responses under random road profile. Simulation results are compared for passive and active quarter car models in time and frequency domain.

II. QUARTER CAR SYSTEM

The dynamic response of an active suspension system is evaluated using three-degrees of freedom model of quarter car system as shown in Fig. 1. This quarter car model is having main suspension connecting sprung mass and unsprung mass as well as seat suspension connecting passenger seat and sprung mass respectively. In this model m_p , m_s and m_{us} represent passenger seat mass, sprung mass and unsprung mass respectively while the damping coefficient and spring stiffness of passenger seat suspension and main suspension are denoted by c_p , c_m , k_p and k_m respectively. The supplied control force by controller in main suspension is represented by F_a . Similarly, displacements of the corresponding masses are z_p , z_s and z_{us} respectively while the road displacement is denoted by z_r .

Devdutt is Associate Professor in Mechanical Engineering Department, Manav Rachna International University, Faridabad, Haryana, India (e-mail: devdutt.ymca@gmail.com).

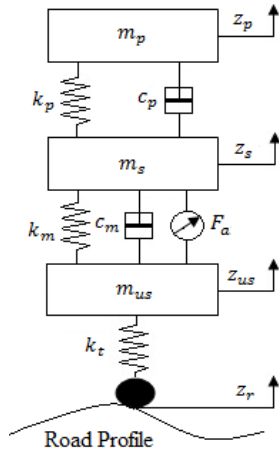

Fig. 1 Active quarter car suspension system

The mathematical equations of active quarter car model with three-degrees-of-freedom are as follows:

$$m_p \ddot{z}_p + c_p(\dot{z}_p - \dot{z}_s) + k_p(z_p - z_s) = 0 \quad (1)$$

$$m_s \ddot{z}_s - c_p(\dot{z}_p - \dot{z}_s) - k_p(z_p - z_s) + c_m(\dot{z}_s - \dot{z}_{us}) + k_m(z_s - z_{us}) + F_a = 0 \quad (2)$$

$$m_{us} \ddot{z}_{us} - c_m(\dot{z}_s - \dot{z}_{us}) - k_m(z_s - z_{us}) + k_t(z_{us} - z_r) - F_a = 0 \quad (3)$$

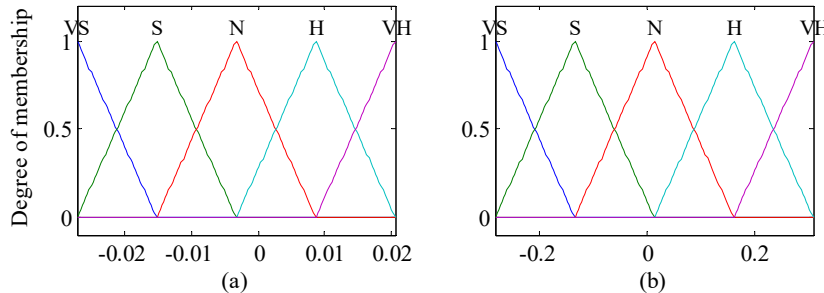
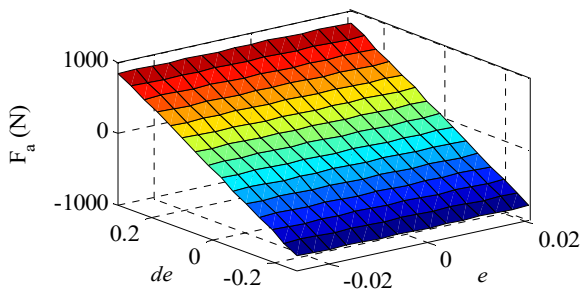

 Fig. 2 Membership functions for (a) error signal, e (b) derivative of error signal, de

Fig. 3 Input/ output ANFIS surface plot

B. Summing Hybrid ANFIS PID Controller

The designed SANFISPID controller is the combination of two controllers i.e. ANFIS and PID controller as shown in Fig. 4. A PID controller is highly successful in control system

III. CONTROLLER DESIGN

In present section, the developed ANFIS and SANFISPID controllers are described for application in main suspension of the selected active quarter car model.

A. ANFIS Controller

Adaptive Neuro-Fuzzy Inference System (ANFIS) structure is the combination of a fuzzy controller and a neural network controller. Neural networks are highly efficient when working with mathematical data due to its parallel computation and learning abilities whereas fuzzy logic can effectively use the human reasoning ability and human knowledge representation. ANFIS is an intelligent control system based on the working of neural network and fuzzy controller. A desired target related to simulation of the input data to the output data can be achieved using ANFIS controller.

The training data set between inputs and output for ANFIS controller design was 170 rows. The selected number of epochs was 50 for training. The number of triangular membership functions for input variables: error (e) and rate of change of error (de) was 5, each having a total 25 ($5 \times 5 = 25$) number of rules. The inputs e and de are represented by five linguistic terms, such as VL: Very Low, L: Low, N: Normal, H: High and VH: Very High respectively. The shapes of the triangular membership functions for e and de after training are shown in Fig. 2. The surface plot for ANFIS controller with two inputs as e and de and an output F_a is shown in Fig. 3.

applications due to its simple design and effectiveness. It delivers better results for linear systems having small deviations from the set reference point. ANFIS controller is capable of delivering satisfying results in the nonlinear systems having high deviations from the set reference point. The designed SANFISPID controller integrates the good characteristics of ANFIS and PID controller.

The signal generated from output side of PID controller, $U_{PID}(t)$ is given by:

$$U_{PID}(t) = K_p[e(t)] + K_I [\sum_{i=0}^t e(t)] + K_D[\dot{e}(t)] \quad (4)$$

where $e(t) = y_{ref} - y$, is the error signal, y_{ref} is the reference position of signal and y is the current position of the signal. Here, $K_p = 950$, $K_I = 80$ and $K_D = 650$ are

proportional, integral and derivative gain respectively for PID controller.

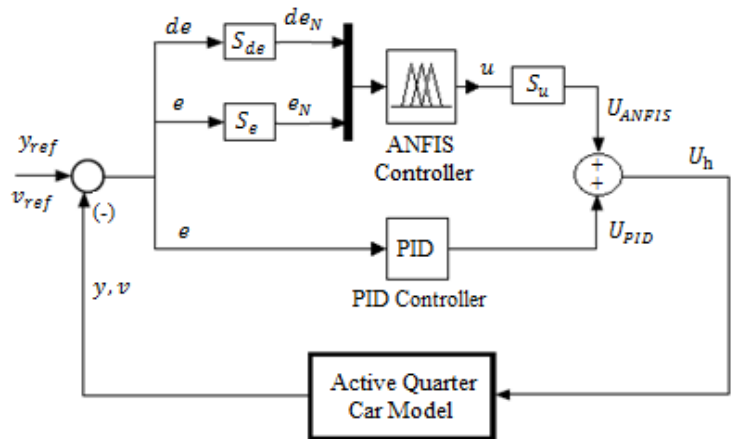

Fig. 4 Summing HANFISPID controller in active quarter car model

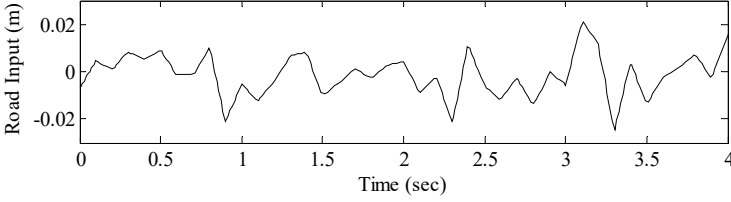

Fig. 5 Random road profile

IV. SIMULATION RESULTS

In present section, the response of quarter car model is studied under random road excitation. The selected random road profile is shown in Fig. 5. The developed passive and active models of quarter car model were run for 4 seconds in simulation environment under the vehicle speed of 40 km/hr using quarter car parameters as given in Appendix in Table III. The passenger ride comfort issues are studied in time domain while frequency domain provides the response of travelling passenger under natural frequency values.

The simulation results related to passenger seat, sprung mass, passenger seat suspension and main suspension are shown in Figs. 6-8. It can be seen from Fig. 6 that passenger

seat acceleration and displacement suppression response are best for SANFISPID controlled suspension system compared to passive and ANFIS controlled suspension system. Sprung mass vibration reduction responses are also much improved for SANFISPID controlled suspension system as seen in Fig. 7. The suspension displacement responses of passenger seat as well as main suspension in Fig. 8 are much controlled by SANFISPID controller in active quarter car model compared to other two considered cases. The damping force supplied in main suspension system as well as power consumed by designed ANFIS and SANFISPID controller are presented in Fig. 9 and Fig. 10, respectively.

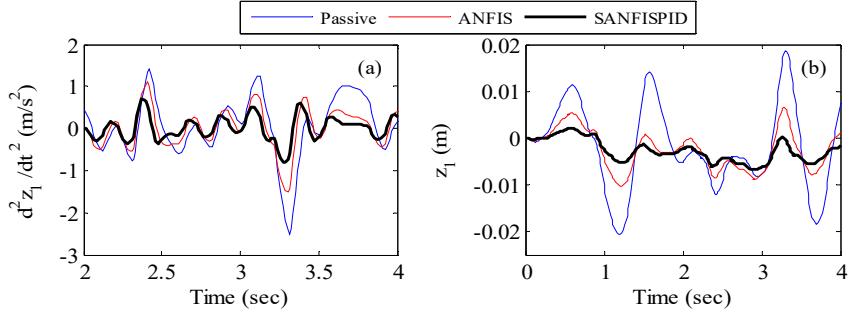

Fig. 6 Passenger seat response (a) acceleration (b) displacement

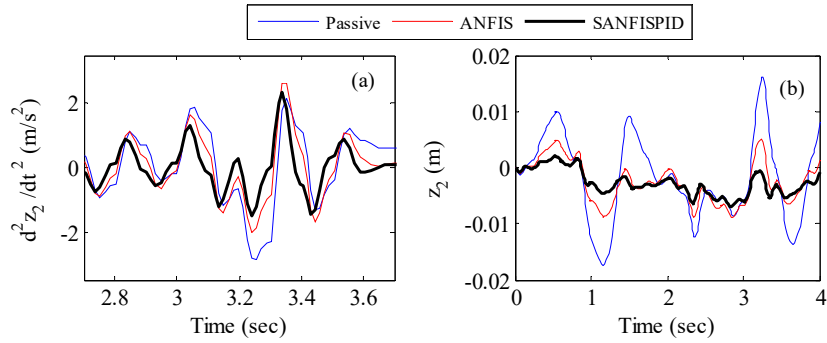

Fig. 7 Sprung mass response (a) acceleration (b) displacement

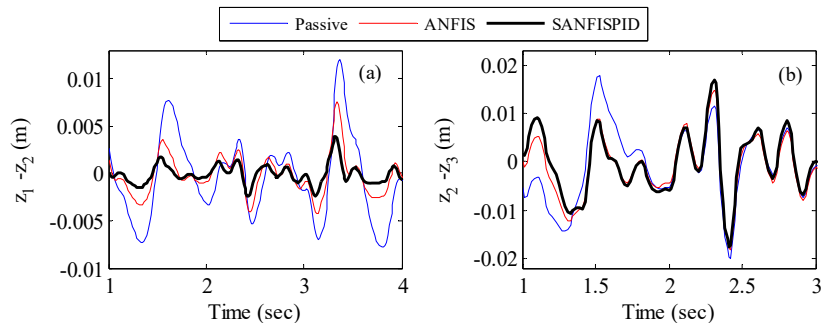

Fig. 8 Suspension stroke response (a) seat suspension displacement (b) main suspension displacement

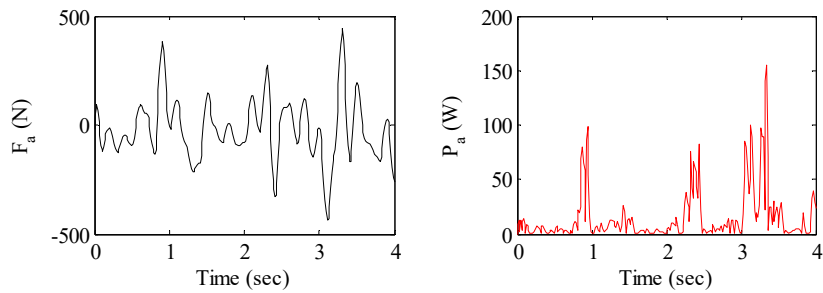

Fig. 9 Damping force supplied by ANFIS controller (b) Power consumed by ANFIS controller

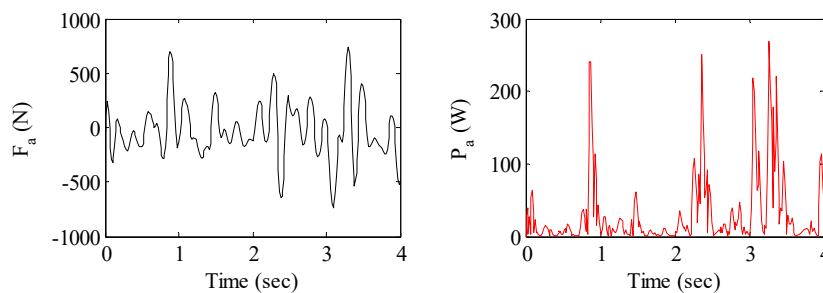

Fig. 10 Damping force supplied by SANFISPID controller (b) Power consumed by SANFISPID controller

Simulation response of passive and active quarter car models is shown in Table I related to passenger seat as well sprung mass acceleration and displacement values. It can be seen from mathematical results that the magnitudes of passenger seat and sprung mass response are much lower in

terms of peak and RMS (root mean square) values for SANFISPID controlled suspension system. It shows the best performance of SANFISPID controller in main suspension of active quarter car model in vibration suppression compared to passive and ANFIS controlled cases.

TABLE I
SIMULATION RESULTS UNDER RANDOM ROAD PROFILE

Measurement point	Controller Type	Acceleration (m/s^2)		Displacement (m)	
		Peak	RMS	Peak	RMS
Passenger seat	Passive	1.4168	0.6565	0.0187	0.0091
	ANFIS	1.0979	0.4171	0.0065	0.0048
	SANFISPID	0.7008	0.2496	0.0021	0.0036
Sprung mass	Passive	2.5714	0.9167	0.0161	0.0075
	ANFIS	2.6436	0.7903	0.0051	0.0044
	SANFISPID	2.3570	0.6195	0.0020	0.0035

V. SPECTRAL DENSITY ANALYSIS

The power spectral density (PSD) signals are obtained using time response data of passenger seat in quarter car model. It can be seen from PSD plots in Fig. 11 that SANFISPID controller decreases the magnitude of PSD signals in highest terms compared to passive and ANFIS controlled suspension system. Thus PSD signal plots also confirm the superior behavior of SANFISPID controlled suspension system in vibration suppression as compared to other cases.

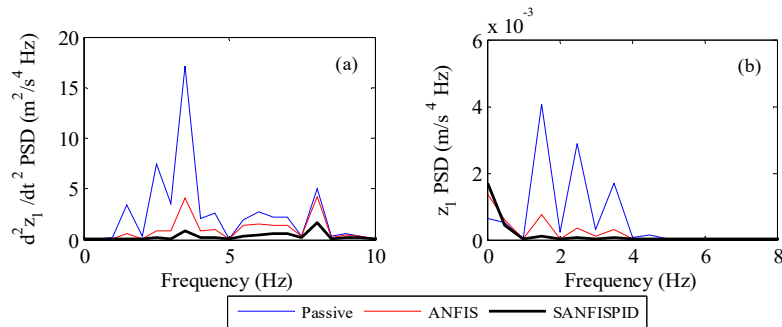

Fig. 11 PSD response of passenger seat under random road profile (a) acceleration (b) displacement

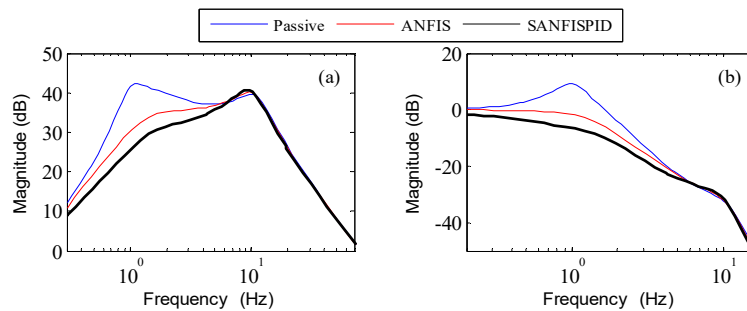

Fig. 12 Bode plot (a) seat acceleration (b) seat displacement

VI. FREQUENCY DOMAIN ANALYSIS

The frequency response plots for three designed quarter car models are shown in Fig. 12. The three resonance frequencies for the passive quarter car model are 0.9431 Hz for passenger seat, 1.8025 Hz for sprung mass and 10.7162 Hz for unsprung mass, respectively. It can be seen from Fig. 12 that passenger seat resonance magnitudes are lower for ANFIS and SANFISPID controlled suspension systems compared to passive one. But much lower values are seen for SANFISPID controlled suspension system, showing its successful performance in frequency domain analysis.

A. Robustness Analysis

In present section, robustness analysis of SANFISPID controller is performed in frequency domain due to its highest effectiveness in an active quarter car suspension system. This analysis is helpful to know the robustness and performance of the controller against changing loading and design parameters of assembled components in an active quarter car model. The selected parameters to study robustness analysis are sprung

mass, main suspension damper damping and spring stiffness variation, respectively. The nominal values of the selected parameters with the variation values are shown in Table II. It can be seen from Figs. 13-15 that SANFISPID controlled suspension system shows robust behavior in frequency domain with variation in sprung mass, damper damping and spring stiffness magnitudes.

VII. CONCLUSION

In this paper, ANFIS controller based SANFISPID controller was developed for application in main suspension of an active quarter car model. Simulation results in time domain under random road input showed that proposed SANFISPID controller was successful in achieving the highest ride comfort and vehicle handling issues in an active quarter car suspension system compared to passive and ANFIS controlled suspension systems. The proposed SANFISPID controller also showed the robustness in frequency domain while the system parameters were varied in simulation work.

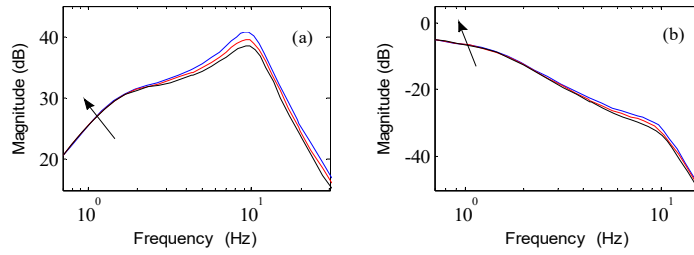

Fig. 13 Bode plot for sprung mass variation (a) seat acceleration (b) seat displacement. The arrow head shows the direction of mass variation

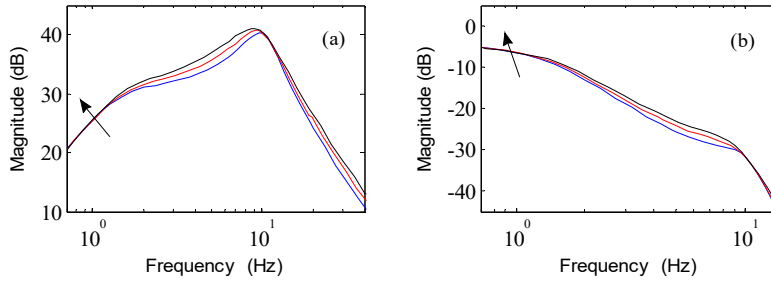

Fig. 14 Bode plot for damping variation (a) seat acceleration (b) seat displacement. The arrow head shows the direction of damper damping variation

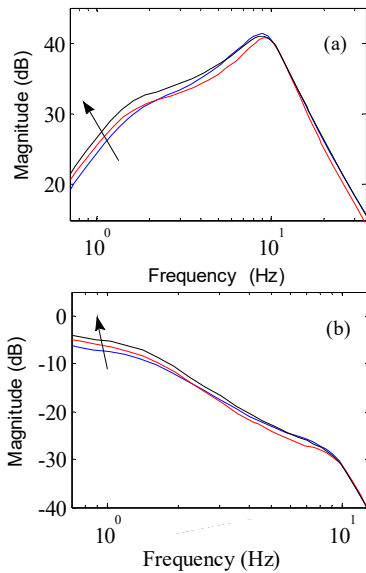

Fig. 15 Bode plot for stiffness variation (a) seat acceleration (b) seat displacement. The arrow head shows the direction of spring stiffness variation

TABLE II
VARIATION OF QUARTER CAR PARAMETERS

Parameter	Nominal Value	Variation
m_s	365 kg	± 40 kg
c_m	1550 N/m/s	± 250 N/m/s
k_m	20000 N/m	± 3500 N/m

APPENDIX

TABLE III
PARAMETER VALUES OF THE QUARTER CAR MODEL

Mass (kg)	Stiffness (N/m)	Damping (Ns/m)
$m_p = 75$	$k_p = 7550$	$c_p = 850$
$m_s = 325$	$k_m = 20000$	$c_m = 1550$
$m_{us} = 40$	$k_r = 180000$	

REFERENCES

- [1] Song, X. B., Ahmadian, M., Southward, S., and Miller, L. R. (2005). An adaptive semiactive control algorithm for magnetorheological suspension systems, *J. Vib. Acoust. Trans. ASME*, 127(5), 493–502.
- [2] Devdutt and Aggarwal, M. L. (2014). Fuzzy control of passenger ride performance using MR shock absorber suspension in quarter car model, *International Journal of Dynamics and Control*, DOI 10.1007/s40435-014-0128-z.
- [3] Gaspar, P., Szaszi, I., and Bokor, J. (2003). Design of robust controller for active vehicle suspension using the mixed μ synthesis, *Vehicle System Dynamics*, 40(4), 193-228.
- [4] Hong, F., and Pang, C. K. (2012). Robust vibration control at critical resonant modes using indirect-driven self-sensing actuation, *Mechatronic Systems, ISA Trans.*, 51, 834–40.
- [5] Fard, H.M., and Samadi F. (2015). Active suspension system control using Adaptive Neuro Fuzzy (ANFIS) controller, *IJE Transactions C: Aspects*, 28(3), 396-401.
- [6] Huang, S. J., and Lin W. C. (2003). A neural network sliding controller for active vehicle suspension, *Materials Science Forum*, 440-441, 119-126.
- [7] Rao, M. V. C., and Prahlad, V. (1997). A tunable fuzzy logic controller for vehicle active suspension system, *Fuzzy Sets Systems*, 85, 11-21.
- [8] Kuo, Y., and Li, T. S. (1999). GA-based fuzzy PI/PD controller for automotive active suspension system, *IEEE Transactions on Industrial Electronics*, 46, 1051–1056.
- [9] Sharkawy, A. B. (2005). Fuzzy and adaptive fuzzy control for the automobile’s active suspension system, *Vehicle System Dynamics*, 43(11), 795-806.
- [10] Yildirim, S., and Eski, I. (2009). Vibration analysis of an experimental suspension system using artificial neural networks, *Journal of Scientific & Industrial Research*, 68, 522-529.
- [11] Lin J., and Lian, R. L. (2011). Hybrid Self-Organizing Fuzzy and Radial Basis-Function Neural-Network Controller for Active Suspension

- Systems, International Journal of Innovative Computing, Information and Control, 7(6), 3359-3378.
- [12] Li, H., Liu, H., Gao, H. and Shi, P. (2012). Reliable Fuzzy Control for Active Suspension Systems with Actuator Delay and Fault, IEEE Transactions on Fuzzy Systems, 20(2), 342-357.
- [13] Kothandaraman, R. and Ponnusamy, L. (2012). PSO tuned Adaptive Neuro-fuzzy Controller for Vehicle Suspension Systems, Journal of Advances in Information Technology, 3(1), 57-63.
- [14] Devdutt and Aggarwal, M. L. (2016). Active Vibration Control of Passenger Seat with HFPIDCR Controlled Suspension Alternatives, International Journal of Mechanical, Aerospace, Industrial, Mechatronic and Manufacturing Engineering, 10(5), 916-23.