

# Analysis of Synchronous Machine Excitation Systems: Comparative Study

Shewit Tsegaye, Kinde A. Fante

**Abstract**—This paper presents the comparison and performance evaluation of synchronous machine excitation models. The two models, DC1A and AC4A, are among the IEEE standardized model structures for representing the wide variety of synchronous machine excitation systems. The performance evaluation of these models is done using SIMULINK simulation software. The simulation results obtained using transient analysis show that the DC1A excitation system is more reliable and stable than AC4A excitation system.

**Keywords**—Excitation system, synchronous machines, AC and DC regulators.

## I. INTRODUCTION

**E**XCITATION system is widely used to provide direct current to the synchronous machine field winding. It also helps to control the field voltage, field current and reactive power flow of the system. It enhances the stability during the start-up of the synchronous machines. Furthermore, in a power system, the protection functions of the excitation system enables to improve the rated capacity limits of the synchronous machines [1].

The main components of an excitation system are automatic voltage regulator (AVR), exciter, measuring elements, power system stabilizer (PSS) and protection unit [2]. The excitation systems can be divided into different categories. In the following section, the detail discussion of the different categories of the excitation systems is provided.

### A. Types of the Excitation Systems

Synchronous machine excitation systems can be classified into three major groups based on the power supply used as source of excitation. These are DC excitation, AC excitation and static excitation systems.

1) *DC Excitation System*: This excitation system utilizes DC generators as source of excitation power. It also provides current to the rotor of synchronous machine through slip rings. The exciter can be driven by a motor or shaft of a generator. It can be either self-excited or separately excited. When it is separately excited, the exciter field current is supplied by a pilot exciter comprising of a permanent magnet generator.

DC excitation systems represent early systems, spanning the years from the 1920s to the 1960s. They lost favor in the mid-1960s and were superseded by ac excitation systems.

Shewit Tsegaye and Kinde A. Fante are with the School of Electrical and Computer Engineering, Jimma Institute of Technology, Jimma University, Jimma, Ethiopia (e-mail: shewittsegaye2@gmail.com).

2) *AC Excitation Systems*: These excitation systems utilize alternators as source of generator excitation power. Usually, the exciter is kept on the same shaft as the turbine generator. The AC output of the exciter is rectified by either controlled or diode rectifiers to produce the direct current which is needed for the generator field. The rectifiers can be stationary or rotating.

AC excitation systems can take many forms depending on the rectifier arrangement, method of exciter output control, and source of excitation for the exciter. Currently, stationary and rotating AC rectifier systems are widely used in AC excitation systems. In stationary rectifiers, the DC output is fed to the field winding of the generator through the slip rings. On the other hand, in rotating rectifiers there is no need of slip rings and brushes. The DC supply is directly fed to the generator field as the armature of the exciter and rectifiers rotate with the generator field. Such systems are known as brush-less systems and were developed to avoid the problems with brushes when extremely high field currents are applied to large generators [3].

3) *Static (ST) Excitation Systems*: All the components of these systems are either static or stationary. Such systems directly provide synchronous generator field winding with excitation current by means of slip rings. Rectifiers in ST systems gain the power from generator through auxiliary windings or a step-down transformer. In such systems, generator is a source of power which means that the generator is self-excited. As the generator cannot produce any voltage without excitation voltage, the generator must have auxiliary power source to provide field current and energize the generator [4]. Station batteries are usually used as additional power sources and the process is known as field flashing.

From the excitation power gain point of view the excitation systems can be further divided into independent and dependent excitation systems. The independent exciter is not connected to the grid. Thus, its excitation parameters have no direct relationship with grid parameters [4]. The dependent exciter utilizes either part of generator power or it is connected to the grid. Its excitation parameters are dependent on grid parameters.

### B. Control and Protection of Excitation System

A modern excitation control system includes a number of control, limiting, and protective functions. Any given excitation system can include only some or all of these functions, depending on the requirements of the specific application and the type of exciter.

The main components of excitation system are voltage regulators, excitation system stabilizers, power system stabilizers, voltage sensing and load compensator, under-excitation limiters, over-excitation limiters, and volts-per-hertz limiters. AC voltage regulator is used to maintain generator stator voltage. It also helps to control the generator excitation voltage. DC voltage regulator is used to hold generator excitation voltage on constant level and it is manually controlled. The regulator is mainly used during tests, start-ups and to cover the AC regulator outages.

## II. LITERATURE REVIEW

Excitation systems stabilizing circuits are used to improve the dynamic performance of the excitation system. The DC and AC excitation systems have elements with significant time constants. Feedback compensation system can be used to minimize the phase shift caused by elements. This contributes to generator stable operation conditions such as prior to the synchronization or after load rejection.

The power system stabilizer (PSS) uses special stabilizing signals in order to control the excitation system and to improve the dynamics of the power system. The basic input signals of PSS are shaft speed, frequency and power. The stabilizer damps rotor oscillations through excitation control. In order to get oscillation damping stabilizers, we have to produce appropriate electric torque component [4].

Load compensation system can be used to control voltage variation at a point which is either external or internal to the generator. The compensator's impedance is required to be adjustable in order to simulate electrical distance between the generator terminals and the point at which the voltage to be controlled [5]. Voltage regulation at the point that is external to the generator is commonly used to provide proper sharing of the reactive power between generators which are connected together. On the other hand, voltage regulation at the point that is internal to the generator is used to compensate the voltage drop on the step up transformers [4], [2].

Under excitation limiter (UEL) is used to prevent generator excitation from dropping to the limit at which generator stability is lost. The limiter input signal is either generator voltage and current, or active and reactive power. The limits are determined by the input signals exceeding the reference level.

The function of over excitation limiter (OEL) is to prevent generator from overheating due to long term excitation. The OEL senses over-current and after some time delay, it reduces the excitation to pre-determined value.

There are two types of time delay: Fixed time and inverse time delay. Fixed time limiter operates when excitation current exceeds reference value during preset time. Inverse time limiter operates with the delay that matches field thermal condition.

Over-flux limiter protects generators and step-up transformers from excessive magnetic flux due to low frequency or over-voltage. Excessive magnetic flux can cause overheating of generator or transformer which leads to permanent damage. Generator protection is applied when

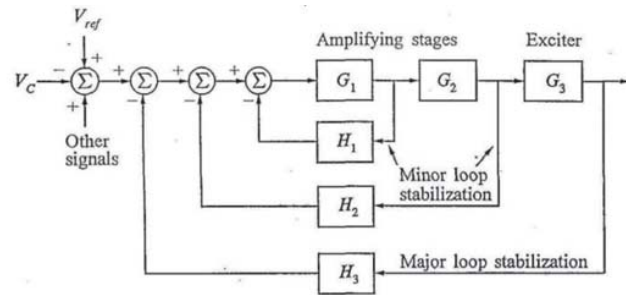

Fig. 1 Structure of a detailed excitation system model ©IEEE 1991

Volt-per-hertz regulator exceeds pre-determined value during specified time [2], [3].

## III. MODEL OF THE EXCITATION SYSTEMS

The mathematical models of excitation systems are used to estimate the parameters of control and protection circuit configurations. It also helps to coordinate the whole system stability. Fig. 1 depicts the general structure of excitation system model. This model has the advantage of retaining a direct relationship between model parameters and physical parameters. In this paper, a model reduction technique is used to simplify and obtain practical model for the system under consideration.

The parameters of the simplified model are selected such that its gain and phase characteristics matches that of the detailed model over the frequency angle from 0 to 3 Hz. All significant non-linearities that affect the system stability are also taken into consideration. However, the direct correspondence between the model parameters and the actual system parameters is generally lost in the simplified model.

IEEE has standardized 12 model structures for representing wide variety of excitation systems. In this work, two models, AC4A and DC1A, are considered for analysis [6]. In the following sections, we illustrate the detail models of the components of the excitation system. The overall model can be represented by using the amplifier, sensor and generator models connected together.

### A. Amplifier Model

The excitation system amplifier can be a magnetic amplifier, rotating amplifier, or electronic amplifier. The amplifier is represented by its gain  $K_A$  and a time constant  $\tau_A$ . Its transfer function is given by:

$$\frac{K_A}{T_A s} = \frac{V_R(s)}{V_e(s)} \quad (1)$$

Typical values of  $K_A$  lies in the range of 10 to 400. The time constant of the amplifier is very small, in the range of 0.02 to 0.1 second, and is often neglected [7].

### B. Generator Model

The emf generated from synchronous machine is a function of its magnetization curve and terminal voltage. It is also

TABLE I  
 THE VALUES OF THE CONSTANTS USED

Component	Gain (K)	Time constant ( $\tau$ )
Amplifier	1	1
Generator	1	1
Sensor	1	0.05

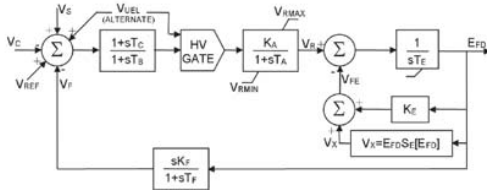

Fig. 2 IEEE type DC1A excitation system model ©IEEE 2005 [7]

dependent on the generator load. In the simplified model, the transfer function that relates the generator terminal voltage and its field voltage can be represented by a gain  $K_G$  and time constant  $\tau_G$ . Its transfer function is given by:

$$\frac{K_G}{T_G s} = \frac{V_T(s)}{V_F(s)} \quad (2)$$

These constants are load-dependent;  $K_G$  can vary from 0.7 to 1, and  $\tau_G$  lies between 1.0 and 2.0 seconds from full-load to no-load [7].

### C. Sensor Model

The voltage is sensed by a potential transformer and it is rectified using a bridge rectifier. The sensor is modeled by a simple first order transfer function as given below.

$$\frac{K_R}{\tau_R s} = \frac{V_S(s)}{V_T(s)} \quad (3)$$

where  $K_R$  denotes the gain of the sensor and  $\tau_R$  is its time constant. The value of  $\tau_R$  is very small in the range of 0.01 to 0.06 second. The block diagram of automatic voltage regulator (AVR), which uses the aforementioned component models, is shown in Fig. 2 [3].

The AVR system of a generator has the following parameters. The DC1A exciter model represents field controlled DC commutator exciters, with continuously acting voltage regulators. The exciter can be separately excited or self-excited, the latter type being more common. When self-excited, the excitation gain ( $K_E$ ) is selected so that initially voltage regulation ( $V_R$ ) is equal to zero. Then it tracks the voltage regulator by periodically trimming the shunt field rheostat to set point [8]. Sample data for DC1A exciter model of self-excited DC exciter are [6]  $K_A = 187$ ,  $\tau_A = 1.15$ ,  $\tau_E = 1.15$ ,  $AEX = 0.014$ ,  $BEX = 1.55$ ,  $K_F = 0.058$ ,  $\tau_F = 0.62$ ,  $\tau_B = 0.06$ ,  $\tau_C = 0.173$ ,  $\tau_R = 0.05$ ,  $V_{RMAX} = 5$  V,  $V_{RMIN} = -1.7$  V.

The AC4A exciter model represents an alternator supplied controlled rectifier excitation system. It has a high initial response excitation system utilizing bridge rectifier. Excitation system stabilization is usually provided in the form of a series lag-lead network (transient gain reduction).

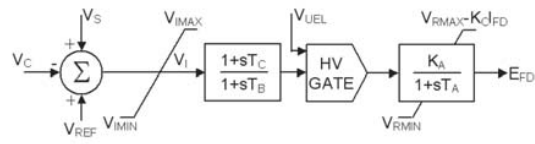

Fig. 3 IEEE type AC4A excitation system model ©IEEE 1991 [4]

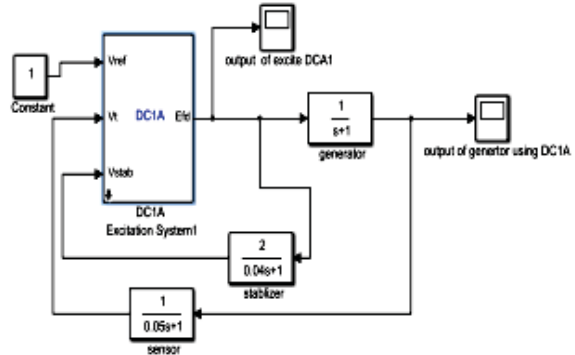

Fig. 4 Software Analysis (SIMULINK based diagram) Using DC1A exciter

The time constant associated with the regulator and firing of the controlled rectifier is represented by  $\tau_A$ . The overall gain is represented by  $K_A$ . The effects of rectifier regulation on exciter output limits are accounted for in the model by constant  $K_C$  [2]. Sample data for AC4A exciter model and regulator are given as follows.  $K_A = 200.0$ ,  $\tau_A = 0.04$ ,  $\tau_C = 1.0$ ,  $\tau_B = 12.0$ ,  $V_{RMAX} = 5.64$ ,  $V_{RMIN} = 4.53$ ,  $K_C = 0$ ,  $V_{IMAX} = 1.0$ ,  $V_{IMIN} = -10$  [1]. The simulink diagram of AC4A exciter is depicted in Fig. 5.

## IV. RESULTS AND DISCUSSIONS

DC1A exciter output is shown in Fig. 6. DC1A exciter output current exponentially decreases from 1.5 to 0.5. Then it becomes constant value which in turn causes the generator output become constant. The output current of generator, which uses DC1A exciter, exponentially increases from zero to 0.5. Then it becomes DC with almost no ripples and oscillations as shown in Fig. 7.

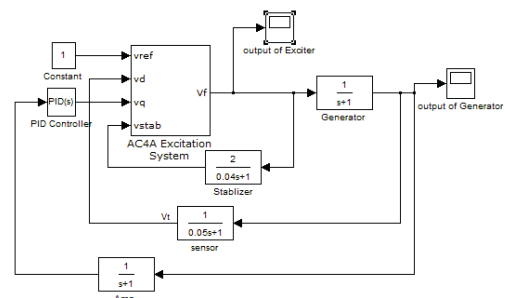

Fig. 5 Software Analysis (SIMULINK based diagram) Using AC4A exciter

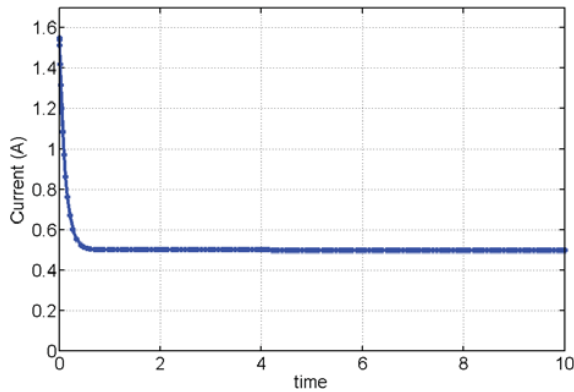

Fig. 6 DC1A exciter output

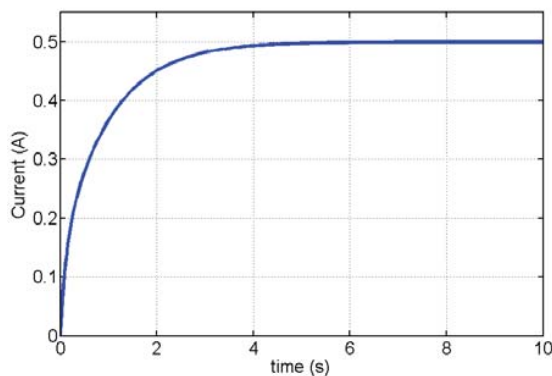

Fig. 7 generator output using DC1A exciter

The output of AC4A exciter is shown in Fig. 8. Contrary to DC1A exciter output, the AC4A exciter output increases from 0.25 to 0.5. Then it becomes DC for some time and decreases to about 0.33 A. This causes the the output of generator, which uses AC4A exciter, to oscillate and to be nonlinear. The generator output increases from 0 to 0.5 for some time. The it becomes straight line from 0.5 to 0.6. Finally, it returns to 0.5 and keeps fluctuating or oscillating.

As we can observe from the results of SIMULINK simulations, the characteristics of the two excitation models is quite different. In the case of the DC1A exciter, the output of the exciter is DC signal with no oscillation. However,

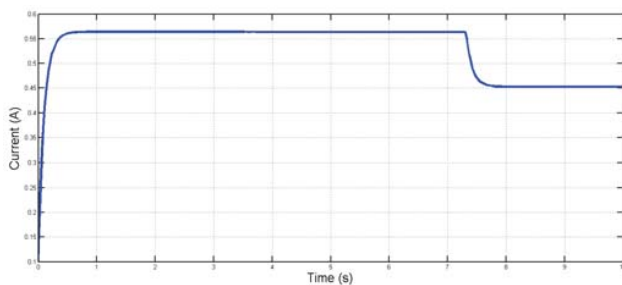

Fig. 8 output of DC1A exciter

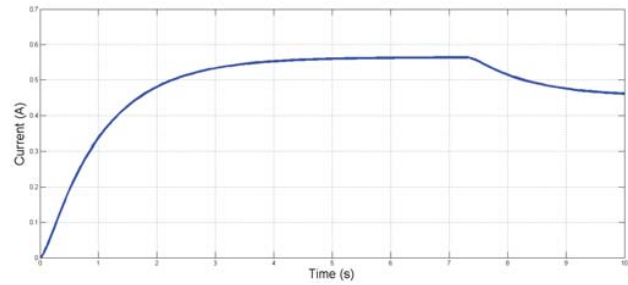

Fig. 9 generator output using AC4A exciter

the output of the AC4A exciter shows that the output has ripple or oscillation stages before its value settles to DC excitation signal. The outputs of the generators are also different. The output of the generator which is connected to the DC1A exciter reaches steady state slower than that of the generator connected to the AC4A exciter. From these results we can conclude that the DC1A excitation system has a better performance in exciter output as well as generator output.

## V. CONCLUSION

In this paper, comparison of two IEEE standard model structures representing synchronous machines, generators in particular is presented. Excitation system model for synchronous machines is very important to deliver field current and to give protection functions. But the most crucial question here is which excitation model structure and exciter is better, reliable and stable.

Based on Simulink simulation results of synchronous machine excitation systems, DC1A IEEE model structure representing synchronous machine excitation system is better, reliable and stable than AC4A.

## REFERENCES

- [1] S. Schmuelling, C. Kreischer, and M. Golebiowski, "Comparison of different methods for excitation of synchronous machines," *KOMEL*, vol. 107, pp. 89–93, 2015.
- [2] M. Catrinou, "Matlab/simulink model of a system for determining the angle of internal synchronous generators."
- [3] R. Jamil, I. Jamil, Z. Jinqian, L. Ming, W. Y. Dong, and R. Jamil, "Control and configuration of generator excitation system as current mainstream technology of power system," *Tc*, vol. 1, no. 1, p. 1, 2013.
- [4] "Ieee guide for synchronous generator modeling practices in stability analyses," *IEEE Std 1110-1991*, pp. 1–, 1991.
- [5] V. Jerković, K. Miklošević, and Š. Željko, "Excitation system models of synchronous generator," in *SiP 2010 28th International Conference Science in Practice*, 2010.
- [6] "transistorized excitation systems for synchronous genertor," (Date last accessed 15-October-2016). [Online]. Available: [https://www.siemens.com.tr/i/content/3882\\_1\\_SipolCatalogue.pdf](https://www.siemens.com.tr/i/content/3882_1_SipolCatalogue.pdf)
- [7] "Ieee recommended practice for excitation system models for power system stability studies," *IEEE Std 421.5-2005 (Revision of IEEE Std 421.5-1992)*, pp. 1–93, April 2006.
- [8] P. Kundur, N. J. Balu, and M. G. Lauby, *Power system stability and control*. McGraw-hill New York, 1994, vol. 7.



**Shewit Tsegaye** was born in Kirkos, Addis Ababa in Ethiopia, on September 3, 1990. He graduated from the Ethiopian institute of technology, Mekelle, and studied at the jimma institute of technology, Jimma University. His special fields of interest included Renewable energy technologies, Matlab based analysis of electrical machines and drives, electrical power systems and power electronics, FACT devices.

Shewit received Bachelor of Science (B.Sc.) degree from Ethiopian institute of technology-Mekelle (EiT-M) in electrical and computer engineering and currently he is engaged in renewable energy technologies researches like geothermal energy production in east African rift valley, Danakil depression and solar water pumping system for condominium residents.

**Dr. Kinde A. Fante** received his B.Sc degree in Electrical Engineering from Bahir Dar University in 2008. He received his M.Tech degree in Electronics and Computer Engineering from Addis Ababa University in 2010. He completed his PhD in Electrical Engineering from Indian Institute of Technology Delhi in 2016. He is working as assistant Professor in Jimma Institute of Technology, Jimma University, Jimma, Ethiopia since July, 2015. His research interests include power electronics, digital, analog and mixed-signal circuit design.