

Design of Two-Channel Quincunx Quadrature Mirror Filter Banks Using Digital All-Pass Lattice Filters

Ju-Hong Lee, Chong-Jia Ciou

Abstract—This paper deals with the problem of two-dimensional (2-D) recursive two-channel quincunx quadrature mirror filter (QQMF) banks design. The analysis and synthesis filters of the 2-D recursive QQMF bank are composed of 2-D recursive digital allpass lattice filters (DALFs) with symmetric half-plane (SHP) support regions. Using the 2-D doubly complementary half-band (DC-HB) property possessed by the analysis and synthesis filters, we facilitate the design of the proposed QQMF bank. For finding the coefficients of the 2-D recursive SHP DALFs, we present a structure of 2-D recursive digital allpass filters by using 2-D SHP recursive digital all-pass lattice filters (DALFs). The novelty of using 2-D SHP recursive DALFs to construct a 2-D recursive QQMF bank is that the resulting 2-D recursive QQMF bank provides better performance than the existing 2-D recursive QQMF banks. Simulation results are also presented for illustration and comparison.

Keywords—All-pass digital filter, doubly complementary, lattice structure, symmetric half-plane digital filter, quincunx QMF bank.

I. INTRODUCTION

2-D QMF banks have been widely considered for processing image and video data in the literature [1], [2]. Without implementing subband coding, a 2-D QMF bank is required to have an exactly linear-phase response without magnitude distortion, i.e. the perfect reconstruction (PR) characteristics. The design problem of 2-D QMF banks with the PR characteristics has been considered in the literature [3], [4].

Recently, a 2-D recursive SHP digital all-pass filter (DAF) has been successfully used for 2-D recursive filter design [5]. A parallel structure using the 2-D recursive SHP DAF to construct the analysis and synthesis filters of a recursive two-channel quincunx QMF (QQMF) bank has been presented in [6]. This QQMF bank possesses the 2-D doubly complementary (DC) half-band (HB) property. This property leads to the favorable results that almost half of the required filter coefficients can be set to zero and only either the passband or stopband response must be approximated during the design of the analysis/synthesis filters. Both advantages reduce the amount of numerical computation during the design process. For image processing, the 2-D QQMF bank can avoid transmission nulls [7] without using additional delays and satisfy the frequency constraints [8], [9] that avoid the aliasing artifacts. However, an

extra SHP DAF used as a phase equalizer must be added at the output of the synthesis system to eliminate the phase distortion induced by the 2-D recursive SHP DAFs in the analysis and synthesis systems.

Similar to 1-D digital lattice filter structure, 2-D digital lattice filters also exhibit the attractive advantages of low passband sensitivity and robustness to quantization error. Moreover, 1-D digital lattice filter structure requires lower computational cost than 1-D direct-form digital filter with similar design specifications. The minimal delay realization for a 2-D digital lattice structure has been presented in [10].

In this paper, we present a novel structure for the design of recursive two-channel quincunx QMF (QQMF) banks using 2-D recursive SHP DALFs. The proposed 2-D QQMF bank possesses the advantages as those presented by [6]; namely, (i) the resulting analysis/synthesis filters possess the 2-D DC properties, i.e. 2-D allpass-complementary and power-complementary properties, (ii) the proposed analysis/synthesis filters possess an attractive DC symmetry with respect to the half-band frequency $(\omega_1, \omega_2) = (\pi/2, \pi/2)$ in the first quarter of the frequency plane, i.e. the DC-HB property, (iii) the proposed 2-D QQMF bank can achieve no magnitude distortion. The frequency characteristics totally depend on the phase responses of the 2-D recursive SHP DALFs. However, the proposed 2-D QQMF bank avoids the need of extra SHP DAF used as a phase equalizer like [6] to achieve satisfactory linear-phase response. Using the stability constraints presented by [11] to guarantee the stability of the 2-D recursive SHP DALFs, we focus the design problem on the least-squares phase approximation. A novel objective function is derived for the phase approximation. As a result, the problem of minimizing the objective function can be solved by using the trust-region Newton conjugate-gradient algorithm [12]. From the simulation results, we observe that the proposed design method outperforms the method of [6].

This paper is organized as follows. Section II presents the theory of 2-D SHP recursive digital all-pass lattice filters (DALFs). In Section III, we propose a novel 2-D QQMF bank based on the 2-D SHP recursive DALFs. We also describe the 2-D DC-HB characteristics possessed by the proposed 2-D SHP recursive DALFs and formulate the least-squares design problem in Section III. Section IV presents an iterative technique for designing the 2-D QQMF bank. We also present the phase constraints to guarantee the stability of the designed results. Section IV provides simulation results for confirming the theoretical work. Finally, we conclude the paper in Section V.

J.-H. Lee is with the Department of Electrical Engineering, Graduate Institute of Communication Engineering, and Graduate Institute of Biomedical Electronics and Bioinformatics, National Taiwan University, No. 1, Sec. 4, Roosevelt Rd., Taipei, 10617, Taiwan (corresponding author; phone: 886-2-23635251; fax: 886-2-23671909, e-mail: jhlee@ntu.edu.tw).

C.-J. Ciou is with the Graduate Institute of Communication Engineering, National Taiwan University, No.1, Sec.4, Roosevelt Rd., Taipei 10617, Taiwan (e-mail: r00942122@ntu.edu.tw).

II. 2-D SHP RECURSIVE DIGITAL ALL-PASS FILTERS

A. Conventional Direct-Form 2-D SHP Recursive DAFs

Consider a 2-D recursive direct-form DAF with order $M \times N$ with its transfer function given by [6]:

$$A(z_1, z_2) = z_1^{-M} z_2^{-N} \frac{D(z_1^{-1}, z_2^{-1})}{D(z_1, z_2)} \quad (1)$$

Assume that $\theta(\omega_1, \omega_2)$ and $\phi(\omega_1, \omega_2)$ represent the phases of $A(z_1, z_2)$ and $D(z_1, z_2)$ respectively. e can obtain from (1) that:

$$\phi(\omega_1, \omega_2) = -\frac{[M\omega_1 + N\omega_2 + \theta(\omega_1, \omega_2)]}{2} \quad (2)$$

The denominator polynomial $D(z_1, z_2)$ has the SHP support region for its coefficients and is given by [6]

$$D(z_1, z_2) = d(0,0) + \sum_{m=-M}^M \sum_{n=1}^N d(m,n) z_1^{-m} z_2^{-n} \quad (3)$$

B. 2-D SHP Recursive DAFs with a Lattice Structure

Let the coefficients $d(-m,n) = d(m,n)$, we rewrite (3) as

$$\begin{aligned} D(z_1, z_2) &= d(0,0) + \sum_{n=1}^N \left[d(0,n) + \sum_{m=1}^M d(m,n)(z_1^{-m} + z_1^m) \right] z_2^{-n} \\ &= d(0,0) + \sum_{n=1}^N c(n, z_1) z_2^{-n} = D(z_1^{-1}, z_2) \end{aligned} \quad (4)$$

where $c(n, z_1)$ is given by:

$$c(n, z_1) = d(0, n) + \sum_{m=1}^M d(m, n)(z_1^{-m} + z_1^m) \quad (5)$$

for $n = 1, 2, \dots, N$. Based on (5), we present a lattice structure as shown in Fig. 4 for realizing a 2-D SHP recursive DAF. The input/output relationship of the p^{th} lattice section in Fig. 4 is expressed by:

$$\begin{bmatrix} Q_p(z_1, z_2) \\ R_p(z_1, z_2) \end{bmatrix} = \begin{bmatrix} 1 & k_p(z_1) z_2^{-1} \\ k_p(z_1) & z_2^{-1} \end{bmatrix} \begin{bmatrix} Q_{p-1}(z_1, z_2) \\ R_{p-1}(z_1, z_2) \end{bmatrix}, \quad (6)$$

for $p = 1, 2, \dots, N$, where

$$k_p(z_1) = r_p(0) + \sum_{m=1}^M r_p(m)(z_1^{-m} + z_1^m), \quad (7)$$

for $p = 1, 2, \dots, N$. By setting $Q_0(z_1, z_2) = R_0(z_1, z_2) = U(z_1, z_2)$ and using the forward recursion given by (6), we can derive

$$\frac{Q_N(z_1, z_2)}{U(z_1, z_2)} = L_N(z_1, z_2) \quad (8)$$

and

$$\frac{R_N(z_1, z_2)}{U(z_1, z_2)} = z_2^{-N} L_N(z_1^{-1}, z_2^{-1}) \quad (9)$$

As a result, the overall transfer function of Fig. 1 is given by:

$$\begin{aligned} \frac{Y(z_1, z_2)}{X(z_1, z_2)} &= z_1^{-M} \frac{R_N(z_1, z_2)}{U(z_1, z_2)} \times \frac{U(z_1, z_2)}{Q_N(z_1, z_2)} \\ &= z_1^{-M} \frac{z_2^{-N} L_N(z_1^{-1}, z_2^{-1})}{L_N(z_1, z_2)} = A(z_1, z_2) \end{aligned} \quad (10)$$

We note from (10) that Fig. 4 generates a lattice-form 2-D SHP recursive DAF $A(z_1, z_2)$ with order $M \times N$. As the 1-D lattice filters, if $|k_p(z_1)| < 1$, for $p = 1, 2, \dots, N$, then $L_N(z_1, z_2)$ will be a minimum-phase polynomial [11].

C. The Relationship between the Direct Form and the Lattice Form

Let a conventional 2-D SHP recursive DAF with transfer function be given by (1). We can find an equivalent transfer function with the proposed lattice structure. As shown by Fig. 4, the polynomial $k_p(z_1)$ can be derived by inverting the recursion (6) as follows:

$$\begin{bmatrix} Q_{p-1}(z_1, z_2) \\ R_{p-1}(z_1, z_2) \end{bmatrix} = \frac{1}{1 - k_p^2(z_1)} \begin{bmatrix} 1 & -k_p(z_1) \\ -k_p(z_1) z_2 & z_2 \end{bmatrix} \begin{bmatrix} Q_p(z_1, z_2) \\ R_p(z_1, z_2) \end{bmatrix} \quad (11)$$

Initially, for $p = N$, we set:

$$Q_p(z_1, z_2) = D_N(z_1, z_2) \quad (12)$$

and

$$R_p(z_1, z_2) = z_2^{-N} D_N(z_1, z_2^{-1}). \quad (13)$$

As a result, we can have

$$k_N(z_1) = c(N, z_1) = d(0, N) + \sum_{m=1}^M d(m, N)(z_1^{-m} + z_1^m) \quad (14)$$

Moreover, we can utilize (11) to recursively derive $Q_{p-1}(z_1, z_2)$ and $R_{p-1}(z_1, z_2)$. Then, one calculates the required function $k_p(z_1)$ to construct the proposed lattice filter structure for $p = N-1, N-2, \dots, 1$.

III. PROPOSED 2-D TWO-CHANNEL QQMF BANKS

A. Conventional 2-D Two-Channel Quincunx QMF (QQMF) Banks

The conventional 2-D two-channel QQMF system is shown in Fig. 2, where $H_0(z_1, z_2)$ and $H_1(z_1, z_2)$ designate the lowpass and highpass analysis filters, respectively, $F_0(z_1, z_2)$ and $F_1(z_1, z_2)$ designate the lowpass and highpass synthesis filters, respectively. \mathbf{M} denotes the quincunx decimation/interpolation matrix. The desired frequency specifications for the 2-D two-channel analysis and synthesis systems are given in Fig. 3.

The analysis filters $H_0(z_1, z_2)$ and $H_1(z_1, z_2)$ of Fig. 2 are constructed by [6] as follows:

$$H_0(z_1, z_2) = \frac{A_1(z_1, z_2) + A_2(z_1, z_2)}{2} \quad (15)$$

and

$$H_1(z_1, z_2) = \frac{A_1(z_1, z_2) - A_2(z_1, z_2)}{2} \quad (16)$$

respectively, where $A_i(z_1, z_2)$, for $i = 1, 2$, are two 2-D DAFs with transform function given by

$$A_i(z_1, z_2) = z_1^{-M_i} z_2^{-N_i} \frac{D_i(z_1^{-1}, z_2^{-1})}{D_i(z_1, z_2)} \quad (17)$$

where the denominator polynomial $D_i(z_1, z_2)$ of the $(M_i \times N_i)$ -th-order DAF $A_i(z_1, z_2)$ with SHP support regions for its coefficients is given by

$$\begin{aligned} D_i(z_1, z_2) &= d_i(0,0) + \sum_{m=-M_i}^M \sum_{n=-N_i}^N d_i(m,n) z_1^{-m} z_2^{-n} \\ &= d_i(0,0) + \sum_{n=1}^N d_i(0,n) z_2^n + \sum_{m=1}^{M_i} \sum_{n=1}^N d_i(m,n) z_1^{-m} z_2^n + \sum_{m=1}^{M_i} \sum_{n=1}^N d_i(m,n) z_1^{-m} z_2^{-n} \\ &= d_i(0,0) + \sum_{n=1}^N d_i(0,n) z_2^n + \sum_{m=1}^{M_i} \sum_{n=1}^N d_i(m,n) z_1^{-m} z_2^n + \sum_{m=1}^{M_i} \sum_{n=1}^N d_i(-m,n) z_1^m z_2^n \end{aligned} \quad (18)$$

We note from (15) and (16) that

$$\left| H_0(e^{j\omega_1}, e^{j\omega_2}) + H_1(e^{j\omega_1}, e^{j\omega_2}) \right| = 1, \text{ for all } (\omega_1, \omega_2) \quad (19)$$

and

$$\left| H_0(e^{j\omega_1}, e^{j\omega_2}) \right|^2 + \left| H_1(e^{j\omega_1}, e^{j\omega_2}) \right|^2 = 1, \text{ for all } (\omega_1, \omega_2) \quad (20)$$

Hence, $H_0(z_1, z_2)$ and $H_1(z_1, z_2)$ simultaneously satisfy the allpass-complementary (19) and power-complementary (20) properties, i.e., $H_0(z_1, z_2)$ and $H_1(z_1, z_2)$ form a 2-D doubly-complementary (DC) filter pair. From (15) and (16), it is easy to show that the 2-D two-channel QQMF system has the transfer function given by

$$T(z_1, z_2) = \frac{1}{2} [H_0^2(z_1, z_2) - H_1^2(z_1, z_2)] = \frac{1}{2} A_1(z_1, z_2) A_2(z_1, z_2) \quad (21)$$

Equation (21) reveals that the QQMF bank possesses perfect magnitude response, i.e. there is no magnitude distortion, and eliminates the aforementioned transmission nulls [7].

B. Proposed 2-D Two-Channel QQMF Banks

First, we use the following decimation/interpolation matrix

$$\mathbf{M} = \begin{bmatrix} 1 & -1 \\ 1 & 1 \end{bmatrix} \quad (22)$$

for generating a quincunx lattice. To facilitate design and implementation, we expect that the proposed 2-D QQMF bank holds the properties possessed by the 2-D QQMF banks of [6] without imposing additional constraints like those of [6] on the values of M_1, M_2, N_1 , and N_2 . Then, a new two-channel QQMF bank is constructed by setting the analysis filters $H_0(z_1, z_2)$ and $H_1(z_1, z_2)$ of Fig. 2 as follows:

$$H_0(z_1, z_2) = \frac{A_1(z_1, z_2) + z_2^{-1} A_2(z_1, z_2)}{2} \quad (23)$$

and

$$H_1(z_1, z_2) = \frac{A_1(z_1, z_2) - z_2^{-1} A_2(z_1, z_2)}{2} \quad (24)$$

Hence, $H_0(z_1, z_2)$ and $H_1(z_1, z_2)$ simultaneously satisfy the allpass-complementary (19) and power-complementary (20) properties, i.e., $H_0(z_1, z_2)$ and $H_1(z_1, z_2)$ form a 2-D doubly-complementary (DC) filter pair. The $H_0(z_1, z_2)$ and $H_1(z_1, z_2)$ of Fig. 2 are replaced by (23) and (24) to form the structure of a novel 2-D QQMF bank as shown in Fig. 4. Using (23) and (24), (21) becomes

$$T(z_1, z_2) = \frac{1}{2} [H_0^2(z_1, z_2) - H_1^2(z_1, z_2)] = \frac{1}{2} z_2^{-1} A_1(z_1, z_2) A_2(z_1, z_2) \quad (25)$$

Equation (25) reveals that the proposed 2-D QQMF bank also possesses perfect magnitude response, i.e. there is no magnitude distortion, and eliminates the transmission nulls as mentioned in Section III. Moreover, from (25), we have the frequency response of the proposed 2-D QQMF bank given by

$$T(e^{j\omega_1}, e^{j\omega_2}) = \frac{1}{2} e^{-j\omega_2} A_1(e^{j\omega_1}, e^{j\omega_2}) A_2(e^{j\omega_1}, e^{j\omega_2}) \quad (26)$$

and from (10), we note that the 2-D SHP DALFs $A_i(z_1, z_2)$, for $i = 1, 2$, have frequency responses given by

$$\begin{aligned} \left. \frac{Y(z_1, z_2)}{X(z_1, z_2)} \right|_{z_1=e^{j\omega_1}, z_2=e^{j\omega_2}} &= z_1^{-M_i} \frac{R_{N_i}(z_1, z_2)}{U(z_1, z_2)} \times \frac{U(z_1, z_2)}{Q_{N_i}(z_1, z_2)} \Big|_{z_1=e^{j\omega_1}, z_2=e^{j\omega_2}} \\ &= z_1^{-M_i} \frac{z_2^{-N_i} L_{N_i}(z_1^{-1}, z_2^{-1})}{L_{N_i}(z_1, z_2)} \Big|_{z_1=e^{j\omega_1}, z_2=e^{j\omega_2}} = A_i(z_1, z_2) \Big|_{z_1=e^{j\omega_1}, z_2=e^{j\omega_2}} \end{aligned} \quad (27)$$

Hence, the phase response $\theta_i(\omega_1, \omega_2)$ of $A_i(z_1, z_2)$ is given by

$$\theta_i(\omega_1, \omega_2) = -M_i - N_i - 2\phi_i(\omega_1, \omega_2) \quad (28)$$

where $\phi_i(\omega_1, \omega_2)$ represents the phase response of $L_{N_i}(e^{j\omega_1}, e^{j\omega_2})$ and is given by

$$\phi_i(\omega_1, \omega_2) = \tan^{-1} \left[\frac{\text{Im} \left\{ L_{N_i}(e^{j\omega_1}, e^{j\omega_2}) \right\}}{\text{Re} \left\{ L_{N_i}(e^{j\omega_1}, e^{j\omega_2}) \right\}} \right] \quad (29)$$

where $\text{Re}\{x\}$ and $\text{Im}\{x\}$ denote the real and imaginary parts of x , respectively. Accordingly, we note from (26) that the phase response $\Phi(\omega_1, \omega_2)$ of the proposed 2-D QQMF bank is given by

$$\Phi(\omega_1, \omega_2) = -(M_1 + M_2)\omega_1 - (N_1 + N_2 + 1)\omega_2 - 2[\phi_1(\omega_1, \omega_2) + \phi_2(\omega_1, \omega_2)] \quad (30)$$

Hence, the frequency response of the proposed 2-D QQMF bank is given by

$$\begin{aligned} T(e^{j\omega_1}, e^{j\omega_2}) &= \frac{1}{2} e^{-j\omega_2} A_1(e^{j\omega_1}, e^{j\omega_2}) A_2(e^{j\omega_1}, e^{j\omega_2}) \\ &= \frac{1}{2} \exp\{j(\theta_1(\omega_1, \omega_2) + \theta_2(\omega_1, \omega_2) - \omega_2)\} \\ &= \frac{1}{2} \exp\{j(-(M_1 + M_2)\omega_1 - (N_1 + N_2 + 1)\omega_2 - 2[\phi_1(\omega_1, \omega_2) + \phi_2(\omega_1, \omega_2)])\} \end{aligned} \quad (31)$$

Let the desired group delays of (31) be $g_1 = M_1 + M_2$ and $g_2 = N_1 + N_2 + 1$ in the ω_1 and ω_2 axes, respectively. According to (23), (24), and (31), we note that the phase responses for the 2-D recursive DALFs $A_1(z_1, z_2)$ and $A_2(z_1, z_2)$ must satisfy the following constraints:

$$\begin{cases} \theta_1(\omega_1, \omega_2) + \theta_2(\omega_1, \omega_2) - \omega_2 = -g_1\omega_1 - g_2\omega_2, \text{ for all } (\omega_1, \omega_2) \\ \theta_1(\omega_1, \omega_2) - \theta_2(\omega_1, \omega_2) + \omega_2 = 0, \text{ for } (\omega_1, \omega_2) \in \Omega_p \\ \theta_1(\omega_1, \omega_2) - \theta_2(\omega_1, \omega_2) + \omega_2 = \pi, \text{ for } (\omega_1, \omega_2) \in \Omega_s \end{cases} \quad (32)$$

where Ω_p and Ω_s denote the passband and stopband of $H_0(e^{j\omega_1}, e^{j\omega_2})$, respectively. Hence, the desired phase responses for $A_1(z_1, z_2)$ and $A_2(z_1, z_2)$ can be set to

$$\theta_{id}(\omega_1, \omega_2) = \begin{cases} -[(M_1 + M_2)\omega_1 + (N_1 + N_2 + 1)\omega_2]/2, & \text{for } (\omega_1, \omega_2) \in \Omega_p \\ -[(M_1 + M_2)\omega_1 + (N_1 + N_2 + 1)\omega_2 - \pi]/2, & \text{for } (\omega_1, \omega_2) \in \Omega_s \end{cases} \quad (33)$$

and

$$\theta_{2d}(\omega_1, \omega_2) = \begin{cases} -[(M_1 + M_2)\omega_1 + (N_1 + N_2 - 1)\omega_2]/2, & \text{for } (\omega_1, \omega_2) \in \Omega_p \\ -[(M_1 + M_2)\omega_1 + (N_1 + N_2 - 1)\omega_2 + \pi]/2, & \text{for } (\omega_1, \omega_2) \in \Omega_s \end{cases} \quad (34)$$

respectively. The desired phase responses for the denominator polynomials $L_{N_1}(z_1, z_2)$ and $L_{N_2}(z_1, z_2)$ can be obtained from (29), (33), and (34) as:

$$\phi_{1d}(\omega_1, \omega_2) = \begin{cases} -[(M_1 - M_2)\omega_1 + (N_1 - N_2 - 1)\omega_2]/4, & \text{for } (\omega_1, \omega_2) \in \Omega_p \\ -[(M_1 - M_2)\omega_1 + (N_1 - N_2 - 1)\omega_2 + \pi]/4, & \text{for } (\omega_1, \omega_2) \in \Omega_s \end{cases} \quad (35)$$

and

$$\phi_{2d}(\omega_1, \omega_2) = \begin{cases} -[(M_2 - M_1)\omega_1 + (N_2 - N_1 + 1)\omega_2]/4, & \text{for } (\omega_1, \omega_2) \in \Omega_p \\ -[(M_2 - M_1)\omega_1 + (N_2 - N_1 + 1)\omega_2 - \pi]/4, & \text{for } (\omega_1, \omega_2) \in \Omega_s \end{cases} \quad (36)$$

respectively. From (35) and (36), we note that

$$\phi_{1d}(\omega_1, \omega_2) + \phi_{2d}(\omega_1, \omega_2) = 0, \text{ for all } (\omega_1, \omega_2) \quad (37)$$

As a result, the frequency response of the proposed 2-D QQMF bank $T(e^{j\omega_1}, e^{j\omega_2})$ possesses the following desired frequency characteristics

$$T(e^{j\omega_1}, e^{j\omega_2}) = \frac{1}{2} \exp\{j(-(M_1 + M_2)\omega_1 - (N_1 + N_2 + 1)\omega_2)\} \quad (38)$$

C. The Design Problem for the Proposed 2-D Two-Channel QQMF Banks

Based on (7) and (37), we can see that the design problem for the proposed 2-D QQMF bank is finding the real coefficients $r_{pi}(m_i)$ for the 2-D recursive SHP DALFs $A_i(z_1, z_2)$, $i = 1, 2$, $pi = 1, 2, \dots, N_i$ and $m_i = 1, 2, \dots, M_i$, such that the following two constraints can be approximately met in some optimal sense:

$$(i) \phi_1(\omega_1, \omega_2) + \phi_2(\omega_1, \omega_2) = 0, \text{ for all } (\omega_1, \omega_2) \quad (39)$$

$$(ii) H_0(e^{j\omega_1}, e^{j\omega_2}) = 0, \text{ for } (\omega_1, \omega_2) \in \Omega_s \quad (40)$$

As to the stability of the 2-D recursive DALFs $A_i(z_1, z_2)$, the authors in [11] have extended the stability constraints for 1-D IIR DAFs [13] to 2-D case. For simplicity, by specifying the desired phase response $\phi_{id}(\omega_1, \omega_2)$ to satisfy the stability constraints, we can neglect the stability problem and focus on the approximation problem given by (39) and (40) only. As a result, we can formulate the least-squares design problem as follows:

$$\text{Minimize } \|\phi_1(\omega_1, \omega_2) + \phi_2(\omega_1, \omega_2)\|_{(\omega_1, \omega_2) \in \Omega_p}^2 + \alpha \|H_0(\omega_1, \omega_2)\|_{(\omega_1, \omega_2) \in \Omega_s}^2 \quad (41)$$

IV. PROPOSED DESIGN TECHNIQUE

In this section, we present a design technique for solving the minimization problem (41). This is an iterative approximation scheme to find the optimal real coefficient $r_{pi}(m_i)$ for the 2-D recursive SHP DALFs $A_i(z_1, z_2)$, $i = 1, 2$, $pi = 1, 2, \dots, N_i$ and $m_i = 1, 2, \dots, M_i$. Finding the optimal coefficients is a highly nonlinear optimization problem. However, it is appropriate to employ the trust-region Newton conjugate gradient method [12] to iteratively solve this problem. In the following, we summarize the iterative design procedure step by step.

Step 1. Specify the ideal phase response $\phi_{id}(\omega_1, \omega_2)$ which

satisfies the stability criterion as presented in Section III for ensuring the stability of the designed 2-D recursive SHP DALFs.

Step 2. At the initial iteration, we set the iteration number $l = 0$ and the coefficients ${}^{(0)}r_{pi}(m_i) = 0$ for the 2-D recursive SHP DALFs $A_i(z_1, z_2)$, $i = 1, 2$, $pi = 1, 2, \dots, N_i$, and $m_i = 1, 2, \dots, M_i$.

Step 3. At the k^{th} iteration, we compute $R_{N_i}(z_1, z_2)$, $Q_{N_i}(z_1, z_2)$, and its corresponding lattice-form polynomial $L_{N_i}(z_1, z_2)$ from (6) and (7) by

calculating the forward recursion as presented in Section II.

Step 4. Compute the objective function defined by (41) over a finite set of discrete frequencies $(\omega_{1i}, \omega_{2j})$, where

$(\omega_{1i}, \omega_{2j})$ denotes the (i,j) th discrete frequency point taken on the 2-D (ω_1, ω_2) plane.

Step 5. Utilize the trust-region optimization method of [12] to compute the adjustment in $r_{pi}(m_i)$, for the 2-D recursive SHP DALFs $A_i(z_1, z_2)$, $i = 1, 2$, $pi = 1, 2, \dots, N_i$, and $m_i = 1, 2, \dots, M_i$.

Step 6. Repeat Steps 3 – 5 and increase the iteration number by one per iteration until a satisfactory design result is achieved.

V. COMPUTER SIMULATION RESULTS

A. The Design Specifications

This example is similar to that considered by [6]. We use the following specifications for the design example: The passband edge frequency $\omega_p = \pi - 1.2$ and the stopband edge frequency $\omega_s = 1.2$. The desired magnitude response of $H_0(e^{j\omega_1}, e^{j\omega_2})$ is given by:

$$|H_{0d}(e^{j\omega_1}, e^{j\omega_2})| = \begin{cases} 1 & \text{for } (\omega_1, \omega_2) \in \Omega_P \\ 0 & \text{for } (\omega_1, \omega_2) \in \Omega_S \end{cases} \quad (42)$$

where

$$\Omega_P = \left\{ (\omega_1, \omega_2) \left| \frac{|\omega_1|}{\pi - 1.2} + \frac{|\omega_2|}{\pi - 1.2} \leq 1 \right. \right\}, \quad (43)$$

$$\Omega_S = \left\{ (\omega_1, \omega_2) \left| \frac{|\omega_1|}{\pi + 1.2} + \frac{|\omega_2|}{\pi + 1.2} \geq 1 \right. \right\}.$$

Only uniformly sampled passband frequency grid points are taken during the design process. Based on the proposed 2-D SHP recursive DALFs, the 2-D QQMF bank is designed by setting $M_1 = M_2 = 7$ and $N_1 = N_2 = 8$. Thus, the number of independent parameters is 64 which is less than 66 of [6]. Moreover, according to (35) for $M_1 = M_2 = 7$ and $N_1 = N_2 = 8$, the resulting desired phase specification for $H_0(e^{j\omega_1}, e^{j\omega_2})$ satisfies the phase stability conditions described in Section III. We would expect that the stability of the designed 2-D SHP recursive DALF is ensured. The 2-D fast Fourier transform used during this design is 70×70 . The relative weight α is set to 30000 for the design. Table I lists the comparison of the significant design results in terms of the following performance parameters:

Passband Magnitude Mean-Squared Errors (PMSE):

$$PMSE = \frac{\sum_{(\omega_1, \omega_2) \in \Omega_P} \left[|H_0(e^{j\omega_1}, e^{j\omega_2})| - |H_{0d}(e^{j\omega_1}, e^{j\omega_2})| \right]^2}{\text{number of grid points in the passband}}$$

Stopband Magnitude Mean-Squared Errors (SMSE):

$$SMSE = \frac{\sum_{(\omega_1, \omega_2) \in \Omega_S} \left[|H_0(e^{j\omega_1}, e^{j\omega_2})| - |H_{0d}(e^{j\omega_1}, e^{j\omega_2})| \right]^2}{\text{number of grid points in the passband}}$$

Peak Stopband Attenuation (PSA):

$$PSA = - \max_{(\omega_1, \omega_2) \in \Omega_S} 20 \log_{10} \left(|H_0(e^{j\omega_1}, e^{j\omega_2})| \right) \text{ (dB)}$$

Passband Phase Mean-Squared Error (PPMSE)

$$PPMSE_i = \frac{\sum_{(\omega_1, \omega_2) \in \Omega_P} \left[\arg \left\{ \text{Denominator of } A_i(e^{j\omega_1}, e^{j\omega_2}) \right\} - \phi_{id}(\omega_1, \omega_2) \right]^2}{\text{number of grid points in the passband (radian}^2)}$$

Peak Phase Distortion (PPD)

$$PPD = \max_{(\omega_1, \omega_2)} \left| \arg \left\{ T(e^{j\omega_1}, e^{j\omega_2}) \right\} - g_1\omega_1 - g_2\omega_2 \right| \text{ (radian)}$$

For the design of using the proposed 2-D recursive SHP DALFs, Fig. 5 shows the magnitude response of the designed $H_0(e^{j\omega_1}, e^{j\omega_2})$. Fig. 6 shows the magnitude response of the designed $H_1(e^{j\omega_1}, e^{j\omega_2})$. Fig. 7 depicts the absolute phase error of the designed denominator $L_{N_1}(e^{j\omega_1}, e^{j\omega_2})$, whereas Fig. 8 plots the absolute phase error of the designed denominator $L_{N_2}(e^{j\omega_1}, e^{j\omega_2})$. Finally, the phase response error of the resulting 2-D QQMF bank is shown in Fig. 9. From the simulation results, we observe that the design method using the proposed 2-D recursive SHP DALFs can provide better results than the existing conventional direct-form design [6].

TABLE I
SIGNIFICANT DESIGN RESULTS FOR THE DESIGN EXAMPLE

	The Proposed Lattice-Form Design	The Direct-Form Design of [6]
PMSE	2.6779×10^{-19}	1.9916×10^{-15}
SMSE	5.5099×10^{-10}	4.4356×10^{-8}
PSA	81.9028	61.1614
PPD	0.0125	0.0608
PPMSE1	7.4678×10^{-7}	3.7283×10^{-8}
PPMSE2	7.4633×10^{-7}	7.4001×10^{-10}
Number of iterations	10	0

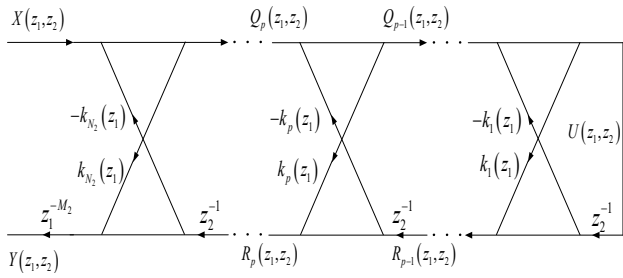

Fig. 1 The proposed 2-D SHP recursive DALF

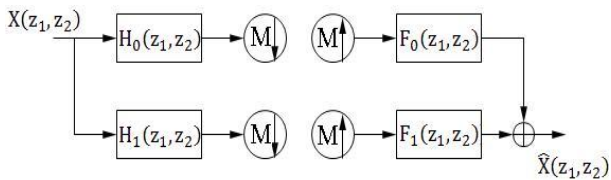

Fig. 2 The structure of conventional 2-D QMF banks

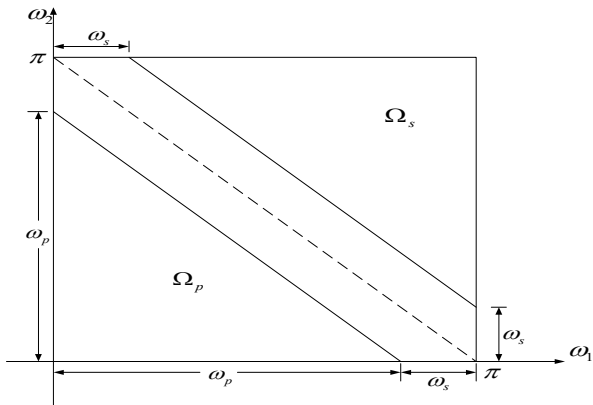

Fig. 3 The ideal frequency band splitting for 2-D QMF banks

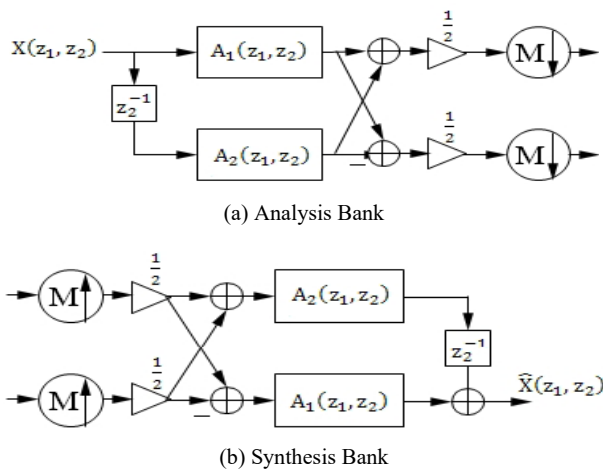

Fig. 4 The analysis/synthesis banks of the proposed 2-D QMF bank

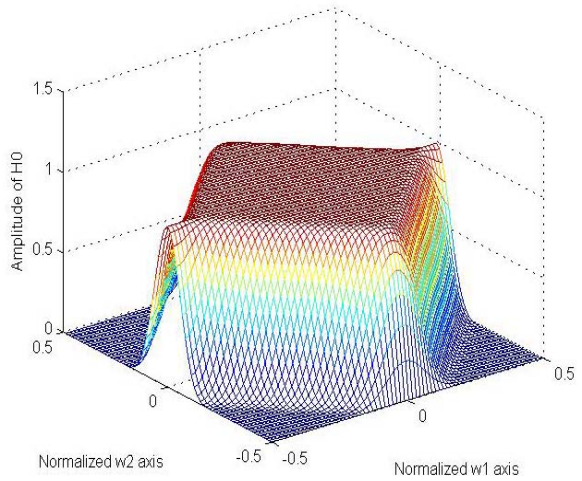

Fig. 5 The magnitude response of the designed $H_0(e^{j\omega_1}, e^{j\omega_2})$

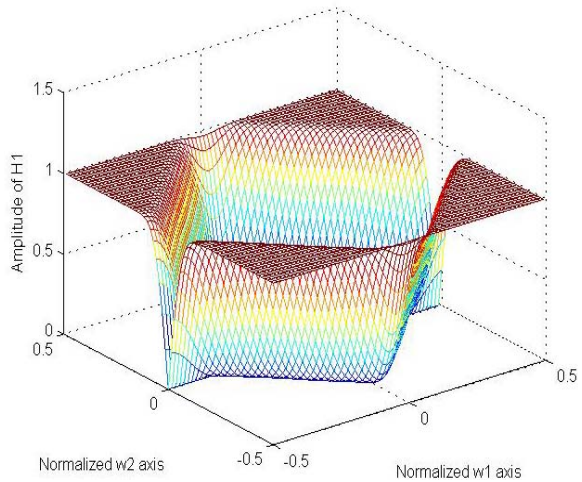

Fig. 6 The magnitude response of the designed $H_1(e^{j\omega_1}, e^{j\omega_2})$

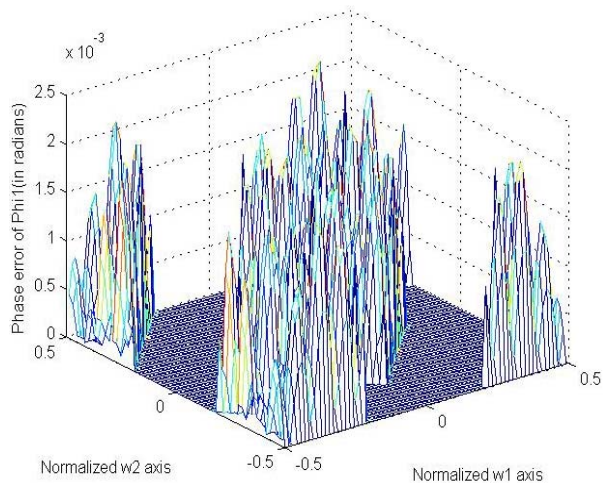

Fig. 7 Phase response error of the denominator of $A_1(e^{j\omega_1}, e^{j\omega_2})$

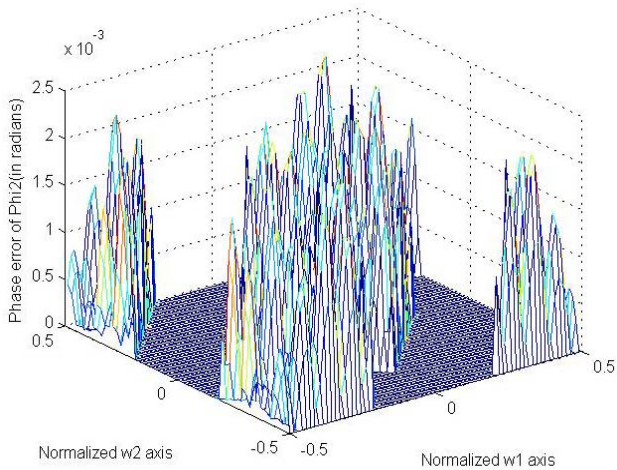

Fig. 8 Phase response error of the denominator of $A_2(e^{j\omega_1}, e^{j\omega_2})$

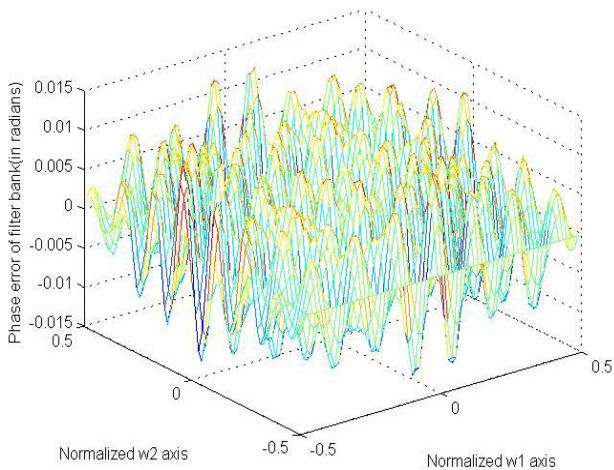

Fig. 9 Phase response error of the design filter bank $T(e^{j\omega_1}, e^{j\omega_2})$

VI. CONCLUSION

This paper has presented a lattice structure of 2-D two-channel quincunx QMF (QQMF) banks using 2-D recursive SHP digital all-pass lattice filters (DALFs). The proposed 2-D SHP QQMF bank possesses a favorable 2-D DC half-band (DC-HB) property that allows about half of the 2-D recursive SHP DALF's coefficients to be zero. The computer simulation results show the effectiveness of the proposed 2-D QQMF bank as compared to the existing conventional 2-D QQMF banks.

ACKNOWLEDGMENT

This work was supported by the Ministry of Science and Technology of TAIWAN under Grant MOST 103-2221-E002-123-MY3.

REFERENCES

- [1] S. I. Park, M. J. Smith, and R. M. Mersereau, "Improved structure of maximally decimated directional filter banks for spatial image analysis",

IEEE Transactions on Image Processing, vol. 13, no. 11, pp. 1424-1431, Nov. 2004.

- [2] T. T. Nguyen and S. P. Orintara, "Multiresolution direction filter banks: Theory, design and application", *IEEE Transactions on Signal Processing*, vol. 53, no. 10, pp. 3895-3905, Oct. 2005.
- [3] Z. Lei and A. P. Makur, "Two-dimensional antisymmetric linear phase filter bank construction using symmetric completion", *IEEE Transactions on Circuits and Systems-II: Express Briefs*, vol. 54, no. 1, pp. 57-60, Jan. 2007.
- [4] P. G. Patwardhan, B. Patil, and V. M. Gadre, "Polyphase conditions and structures for 2-D quincunx FIR filter banks having quadrantal or diagonal symmetries" *IEEE Transactions on Circuits and Systems-II: Express Briefs*, vol. 54, no. 9, pp. 790-794, Sept. 2007.
- [5] J.-H. Lee and Y.-H. Yang, "Two-dimensional recursive digital filters with nearly circular-symmetric magnitude response and approximately linear phase," *International Journal of Circuit Theory and Applications*, vol. 39, no. 12, pp. 1215-1229, Dec. 2011.
- [6] J.-H. Lee and Y.-H. Yang, "Two-channel quincunx QMF banks using two-dimensional digital allpass filters," *IEEE Transactions on Circuits and Systems - I*, vol. 56, no. 12, pp. 2644-2654, Dec. 2009.
- [7] M. Vetterli and G. Karlsson, "Theory of two-dimensional multirate filter banks," *IEEE Transactions on Acoustics, Speech and Signal Processing*, vol. 38, no. 6, pp. 925-937, June 1990.
- [8] P. Siohan, "2-D FIR filter design for sampling structure conversion," *IEEE Transactions on Circuits and Systems for Video Technology*, vol. 1, no. 4, pp. 337-350, Apr. 1991.
- [9] A. Knoll, "Filter design for the interpolation of highly subsampled pictures," *Signal Processing: Image Communication*, vol. 3, pp. 239-248, 1991.
- [10] G. E. Antoniou, "2-D lattice discrete filters: minimal delay and state space realization," *IEEE Signal Processing Letters*, vol. 8, no. 1, pp. 23-25, Jan. 2001.
- [11] S. C. Pei and J.-J. Shyu, "Eigenfilter design of 1-D and 2-D IIR digital all-pass filters," *IEEE Transactions on Signal Processing*, vol. 42, no. 4, pp. 966-968, Apr. 1994.
- [12] J. Nocedal and S. J. Wright, *Numerical Optimization*, New York: Springer-Verlag, 1999.
- [13] Vaidyanathan P. P. *Multirate Systems and Filter Banks*. New Jersey, Prentice Hall: Englewood Cliffs, 1992.