

Optimal Design of Multimachine Power System Stabilizers Using Improved Multi-Objective Particle Swarm Optimization Algorithm

Badr M. Alshammari, T. Guesmi

Abstract—In this paper, the concept of a non-dominated sorting multi-objective particle swarm optimization with local search (NSPSO-LS) is presented for the optimal design of multimachine power system stabilizers (PSSs). The controller design is formulated as an optimization problem in order to shift the system electromechanical modes in a pre-specified region in the s -plan. A composite set of objective functions comprising the damping factor and the damping ratio of the undamped and lightly damped electromechanical modes is considered. The performance of the proposed optimization algorithm is verified for the 3-machine 9-bus system. Simulation results based on eigenvalue analysis and nonlinear time-domain simulation show the potential and superiority of the NSPSO-LS algorithm in tuning PSSs over a wide range of loading conditions and large disturbance compared to the classic PSO technique and genetic algorithms.

Keywords—Multi-objective optimization, particle swarm optimization, power system stabilizer, low frequency oscillations.

I. INTRODUCTION

LOW frequency electromechanical oscillations in power system has attracted much attention in the recent years. These oscillations are very poorly damped and may result a serious consequence such as overload in several lines of the system and fatigue at the generators. Several works [1], [2] have demonstrated that PSSs are very effective for improvement of power system stability. The main function of PSS is to introduce damping torque to the rotor oscillations through the excitation system. Recently, considerable researches have been focused on the designing and using of adequate PSSs for damping of low frequency oscillations [3]-[11] such as phase compensation in the frequency domain and root locus [3], eigenvalue sensitivity analysis [4], and poles placement [5]. In [6], [7], the PSS tuning problem is converted into linear matrix inequality (LMI) problem whose solution determines the stabilizer parameters. A novel LMI feasibility problem with a rank condition has been described in [8] to the design of robust low order PSS. However, simulation results are carried out based on a one machine test system. Unfortunately, some of above approaches are sequential methods which only consider the damping enhancement of one critical electromechanical mode at a time. In addition, they are iterative techniques and require an initialization step. For this reason, the search process can converge to local

optima. To overcome the limitations of these techniques, some soft computing-based methods have been proposed during this decade. In [9], [10], genetic algorithms were implemented for the robust PSS design. Two objective functions based on the eigenvalue analysis have been considered to place the closed-loop system eigenvalues in a pre-specified zone in the s -plan. The multi-objective problem (MOP) is converted into mono-objective problem by evaluating the objectives with distinct weights. So, there is a loss of diversity in the Pareto solutions. In [11], the authors have presented a bat-based fuzzy algorithm for robust design of PSS where time-domain based objective functions are used. Another evolutionary computation algorithm, called bacteria foraging algorithm (BFA) based optimal neuro-fuzzy scheme, is developed in [12], [13] to design intelligent adaptive PSSs for enhancement of the transient and dynamic stability of multimachine power systems. Nevertheless, The BFA depends on random search directions which may lead to delay in reaching the global solution.

In recent years, PSO algorithms have attracted much attention for solving various power system problems [14], [15]. This heuristic technique was introduced by Kennedy and Eberhart [16]. It was presented as a robust and well-balanced mechanism to enhance and adapt the global and local exploration abilities within a short calculation time.

A PSO based approach for optimal tuning of PSS parameters is proposed in [17], [18]. However, the main drawback of the conventional PSO is its premature convergence, while the problem has multiple minima and with nonconvex objective functions. To overcome this drawback and exploit this technique for MOPs, many researchers suggested different changes in the original PSO. Unfortunately, these modified PSO approaches have been applied to optimize one objective function [18]. Thus, if it is a MOP, all objectives are weighted as per the importance and added together to form a single objective function. Thus, there is a loss of diversity in Pareto optimal solutions.

To overcome the above problems, this paper proposes a new elitist multi-objective PSO (MOPSO) approach with local search based on the nondominated sorting concept for the enhancement of power system stability. Two eigenvalue-based objective functions have been considered. This proposed nondominated sorting MOPSO with local search (NSPSO-LS) incorporates the main mechanisms of the NSGAI given in [19] into the MOPSO algorithm. Local search procedure was added to facilitate the convergence of the NSPSO-LS to the

Badr M. Alshammari and T. Guesmi are with the Electrical Engineering Department, College of Engineering, University of Hail, Saudi Arabia (e-mail: badr_ms@hotmail.com, t.guesmi@uoh.edu.sa).

real Pareto optimal front.

To demonstrate the effectiveness and robustness of the proposed controllers, the 3-machine 9-bus system is considered. Eigenvalue analysis and nonlinear simulations show the superiority of the proposed stabilizers to provide efficient damping over wide range of loading conditions and severe fault compared to PSO and genetic algorithms (GA).

II. OVERVIEW OF PSO METHOD

PSO firstly introduced by Kennedy and Eberhart [16], emulates the social behavior of organisms such as flocking of birds and schooling of fish. PSO system can be considered as artificial intelligence based heuristic optimization techniques, in which a population of random solutions called particles is initialized. These particles fly through a multidimensional search space. During flight, each particle adjusts its position according to its own experience, and the experience of the neighboring particles to search for the optimal solution.

In a physical-dimensional search space with the dimension n , the i^{th} particle at iteration k is presented by its position $X_i^k = (X_{i1}^k, \dots, X_{in}^k)$ and velocity $V_i^k = (V_{i1}^k, \dots, V_{in}^k)$. The updated velocity and position of this particle at the next generation $(k+1)$ can be governed, respectively, by:

$$V_i^{k+1} = wV_i^k + c_1r_1(pbest_i^k - X_i^k) + c_2r_2(gbest^k - X_i^k) \quad (1)$$

$$X_i^{k+1} = X_i^k + V_i^{k+1} \quad (2)$$

where w is the inertia weight factor, c_1 and c_2 are acceleration constants. The coefficients w , c_1 , and c_2 can be determined according to [16]. r_1 and r_2 are two random numbers between 0 and 1. $pbest_i^k$ and $gbest^k$ are the best position of the i^{th} particle achieved based on its own experience and the best position among all the particles in the swarm at the k^{th} iteration, respectively.

III. PROPOSED NSPSO-LS APPROACH

In the literature [20], [21], PSO technique has been considered as an effective engine for multi-objective optimization. Therefore, several MOPSO algorithms have been proposed. These algorithms use an archive or repository to stock the nondominated solutions found so far by the search process using the concept of Pareto dominance. Each particle randomly selects a nondominated solution from this repository as the global guide of its next flight. Nevertheless, it has been mentioned in some researches that MOPSO [20] cannot ensure diversity of the Pareto front and they may have difficulties when solving complex problems because of its limited operators. Recent researches [19] have demonstrated that elitism can improve performance of optimization algorithms and ensure the survival of good candidates once they have been found. Therefore, a new version of the MOPSO approach

based on the nondominated sorting concept, has been developed in this paper and used for optimum PSS design. At each iteration k , this elitist approach extends the basic form of PSO by combining the pbest of N particles P^k and the N particles offspring Q^k . The combined population $R^k = P^k \cup Q^k$ of size $2N$ will be sorted into different nondomination levels F_j [19]. Therefore, we can write.

$$R^k = \bigcup_{j=1}^r F_j \quad (3)$$

where, r is the number of fronts.

Once the nondominated sorting is completed, a crowding distance, as given in [19], is assigned to each solution of the combined population R^k to provide an estimate of the density of solutions surrounding that solution in the same front F_j .

Thus, every solution in R^k has two indices, nondomination level and crowding distance. Then, particles of the next population P^{k+1} will be the first N individuals of the subsequent nondominated fronts in the order of their levels. i.e., members of F_1 have priority to will be in P^{k+1} , followed by members from F_2 , and so on until the number of these individuals is greater than or equal to N . Let us consider that F_j is the last nondominated set. Then, individuals of F_j will be selected to fill P^{k+1} according to their crowding distance in the descending order. The global best position is selected randomly from the 5% of the top crowded solutions of F_1 .

In order to facilitate the convergence of the NSPSO to the true Pareto-optimal front and maintain the diversity of the external archive, a local search procedure is incorporated at the end of each iteration. This procedure explores the less-crowded area in the current archive in order to obtain more nondominated solutions nearby. The flowchart of the local search algorithm applied for an iteration k is shown in Fig. 1. However, the basic steps of the proposed NSPSO-LS are illustrated in Fig. 1.

IV. SYSTEM MODELING

A. Generator Modeling

In this study, each i^{th} synchronous machine is modeled by the following third-order nonlinear differential equations [1].

$$\dot{\delta}_i = \omega_b (\omega_i - 1) \quad (4)$$

$$\dot{\omega}_i = \frac{1}{M_i} (P_{mi} - P_{ei} - D_i (\omega_i - 1)) \quad (5)$$

$$\dot{E}_{qi} = \frac{1}{T_{d0i}} (E_{fdi} - (x_{di} - x'_{di}) i_{di} - E'_{qi}) \quad (6)$$

where δ_i and ω_i are rotor angle and angular speed of the machine. ω_b is the base frequency in rad/sec. P_{mi} and P_{ei} are the mechanical input and the electrical output powers for the machine i , respectively. D_i and M_i are the damping coefficient and inertia constant, respectively. E_{fdi} and E'_{qi} are the field and the internal voltages, respectively. i_d is the d-axis armature current. x_d and x'_d are the d-axis transient reactance and the d-axis reactance of the generator, respectively. T'_{d0} is the open circuit field time constant.

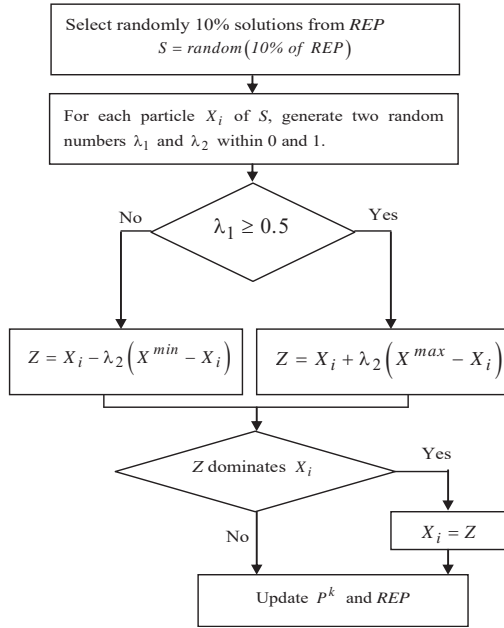

Fig. 1 Flowchart of the local search algorithm

The electrical torque T_e can be expressed by

$$T_e = E'_{qi} i_{qi} - (x_{qi} - x'_{di}) i_{di} i_{qi} \quad (7)$$

B. PSS with Excitation System Structure

The IEEE type-ST1 excitation system with PSS shown in Fig. 2 is considered in this paper, where K_{Ai} and T_{Ai} are the regulator gain and the regulator time constant of the excitation system, respectively. V_{refi} and V_{ti} are reference and generator terminal voltages of the i^{th} machine, respectively. The field voltage can be modeled by:

$$\dot{E}_{fdi} = \frac{1}{T_{Ai}} \left(-E_{fdi} + K_{Ai} (V_{refi} - V_{ti} + U_i) \right) \quad (8)$$

As shown in Fig. 2, the PSS representation consists of a gain K_i , a washout block with time constant T_{wi} , and two lead-lag blocks. Its input signal is the normalized speed

deviation, $\Delta\omega_i$, while the output signal is the supplementary stabilizing signal, U_i .

In Fig. 2, the washout bloc with time constant T_w is used as high-pass filter to leave the signals in range 0.2-2 Hz associated with rotor oscillation to pass without change. In general, it is in the range of 1-20 s. In this study, $T_w = 5$ s. The two first order lead-lag transfer functions serve to compensate the phase lag between the PSS output and the control action which is the electrical torque.

V. DAMPING CONTROLLER DESIGN

After linearizing the power system model around the operating point, the closed-loop eigenvalues of the system are computed and the desired objective functions can be formulated using only the unstable or lightly damped electromechanical modes that need to be shifted.

In this paper, two eigenvalue-based objective functions are considered in order to solve the problem of parameters tuning of the PSS controllers. The first one consists in shifting the unstable and lightly damped electromechanical modes into the left-side of the line defined by $\sigma = \sigma_0$ in the s-plan. This function is expressed by J_1 in (9). The second function J_2 given by (10) aims to place these modes in the wedge-shape sector defined by $\xi_{i,j} \geq \xi_0$.

$$J_1 = \sum_{j=1}^{np} \sum_{\sigma_{i,j} \geq \sigma_0} (\sigma_0 - \sigma_{i,j})^2 \quad (9)$$

$$J_2 = \sum_{j=1}^{np} \sum_{\xi_{i,j} \leq \xi_0} (\xi_0 - \xi_{i,j})^2 \quad (10)$$

where np is number of operating points. $\sigma_{i,j}$ and $\xi_{i,j}$ are respectively, real part and damping ratio of the i^{th} eigenvalue corresponding to the j^{th} operating point.

In the design process, the adjustable parameter bounds given by (11)-(15) must be respected.

$$K^{\min} \leq K \leq K^{\max} \quad (11)$$

$$T_1^{\min} \leq T_1 \leq T_1^{\max} \quad (12)$$

$$T_2^{\min} \leq T_2 \leq T_2^{\max} \quad (13)$$

$$T_3^{\min} \leq T_3 \leq T_3^{\max} \quad (14)$$

$$T_4^{\min} \leq T_4 \leq T_4^{\max} \quad (15)$$

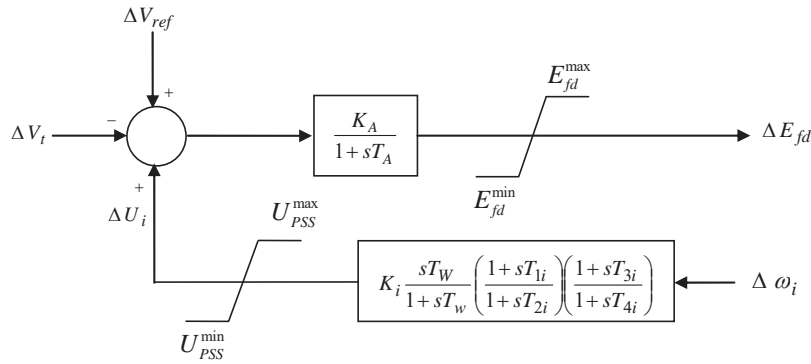

Fig. 2 IEEE Type-ST1 excitation system with PSS

VI. SIMULATION AND RESULTS

A. Test System

In this study, the 3-machine 9-bus (WSSC) shown in Fig. 3 is considered. The system data in detail are given in [22]. It is assumed that all generators except G1 are equipped with PSS.

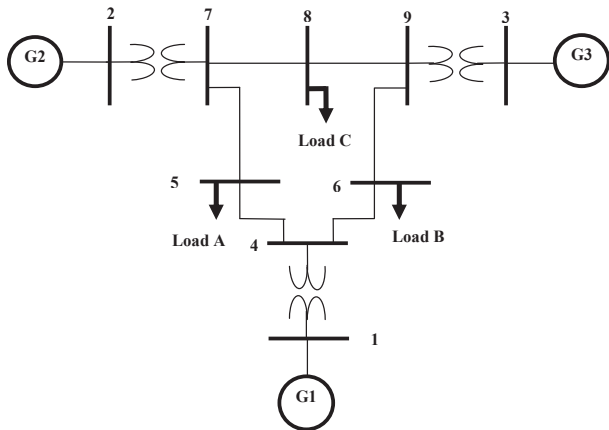

Fig. 3 Test system

The operating conditions corresponding to the nominal load, heavy load, and light load are given in Table I. The threshold parameters of the D-shape sector σ_0 and ξ_0 are respectively, -1 and 20%. The washout time constant T_w is fixed to 5 s. Typical ranges of the decision variables are [0.1-50] for K_i and [0.01-1.5] for T_{1i} to T_{4i} .

TABLE I
LOADING CONDITIONS (IN PU.)

Generator	Nominal		Heavy		Light	
	P [pu]	Q [pu]	P [pu]	Q [pu]	P [pu]	Q [pu]
G ₁	0.72	0.27	2.21	1.09	0.33	1.12
G ₂	1.63	0.07	1.92	0.56	2.00	0.57
G ₃	0.85	-0.11	1.28	0.36	1.50	0.38
A	1.25	0.50	2.00	0.80	1.50	0.90
B	0.90	0.30	1.80	0.60	1.20	0.80
C	1.00	0.35	1.50	0.60	1.00	0.50

B. NSPSO-LS Based PSS Design and Eigenvalues Analysis

The optimum PSS parameters obtained by the proposed NSPSO-LS, GA and PSO are given in Table II.

TABLE II
OPTIMAL SETTING PARAMETERS

Method	Gen	K	T ₁	T ₂	T ₃	T ₄
NSPSO-LS	G2	17.012	0.4104	0.0500	0.4194	0.0500
	G3	4.8847	1.1979	0.0500	0.4771	0.0500
PSO	G2	15.629	0.5928	0.4425	1.4801	0.3038
	G3	5.8846	0.5310	0.7011	1.1244	0.0500
GA	G2	8.7586	0.1574	0.0500	0.1697	0.0500
	G3	0.0782	0.6049	0.0500	0.6748	0.0500

Table III shows the electromechanical modes corresponding to the NSPSO-LS and PSO algorithms. It is clear that the proposed approach gives the best results.

TABLE III
ELECTROMECHANICAL MODE AND DAMPING RATIOS

	NSPSO-LS		PSO	
	Real	Imaginary	Real	Imaginary
Nominal	-3.0193	±j9.2272, 0.3110	-2.1008	±j9.7770, 0.2101
	-4.5024	±j12.8367, 0.3310	-2.4967	±j13.1934, 0.1859
Heavy	-3.6515	±j9.0255, 0.3750	-2.4865	±j9.8908, 0.2438
	-4.2888	±j12.9153, 0.3151	-2.3821	±j13.2230, 0.1773
Light	-3.4793	±j8.4131, 0.3822	-2.4136	±j9.2545, 0.2524
	-4.5289	±j13.1764, 0.3250	-2.5124	±j13.4887, 0.1831

C. Nonlinear Time-Domain Simulation

The effectiveness and robustness of the proposed approach in improving the system damping characteristics are verified by nonlinear time-domain simulation. A 6-cycle three-phase fault at bus 7 at the end of line 5-7 is considered. The fault is cleared by tripping the line 5-7 with successful reclosure after 1.0 s. The rotor speed deviations of generators for the operating conditions are shown in Figs. 4-6. From these figures, it can be seen that the response with NSPSO-LS based controllers shows good damping characteristics to low frequency oscillations, and the system is more quickly stabilized than GA and PSO based stabilizers.

Figs. 7-9 show the variation of the PSS output over the loading conditions. It is clear that the proposed stabilizer gives the best oscillation damping.

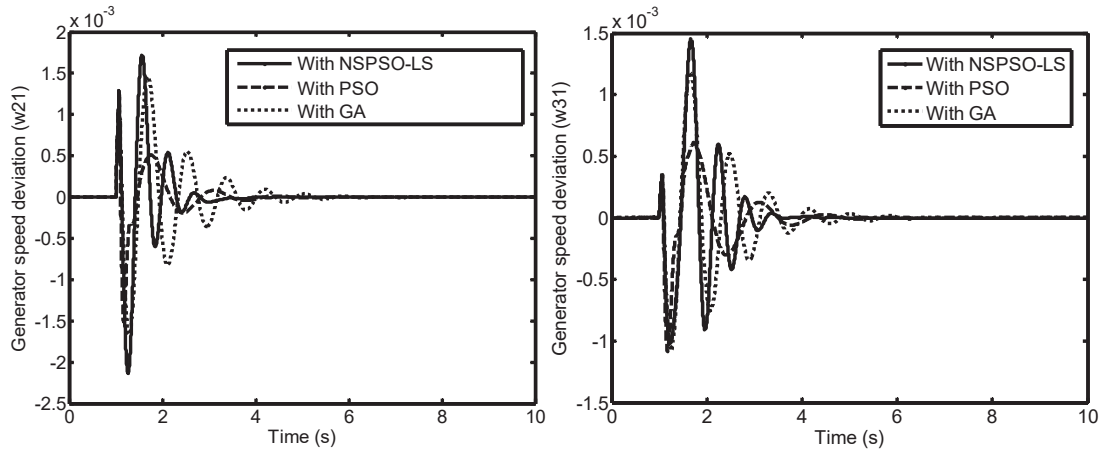

Fig. 4 Speed response for nominal load

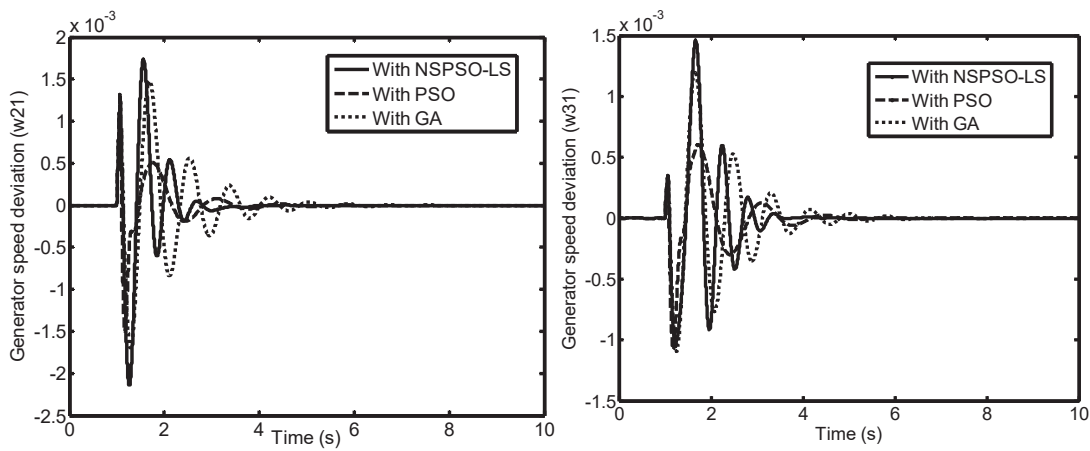

Fig. 5 Speed response for light load

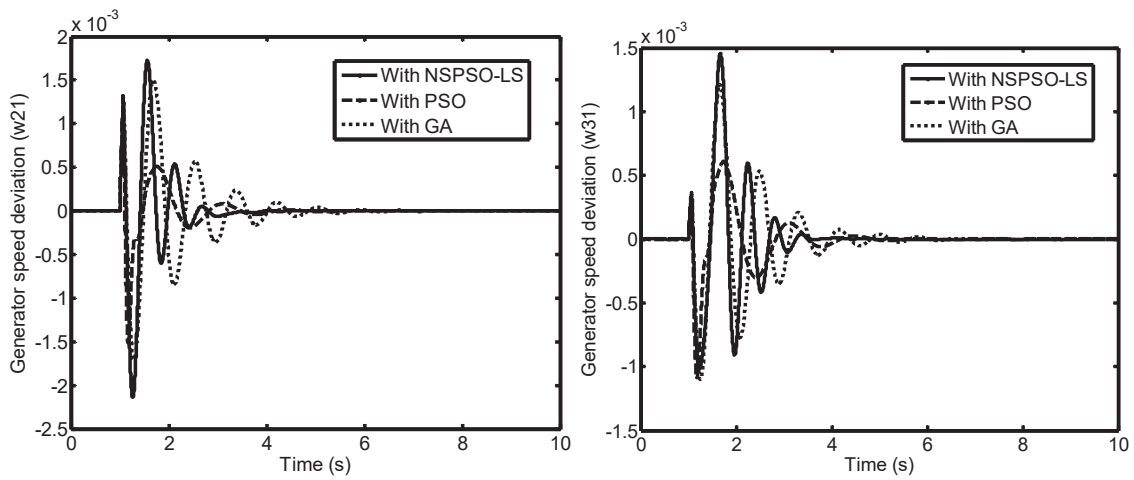

Fig. 6 Speed response for heavy load

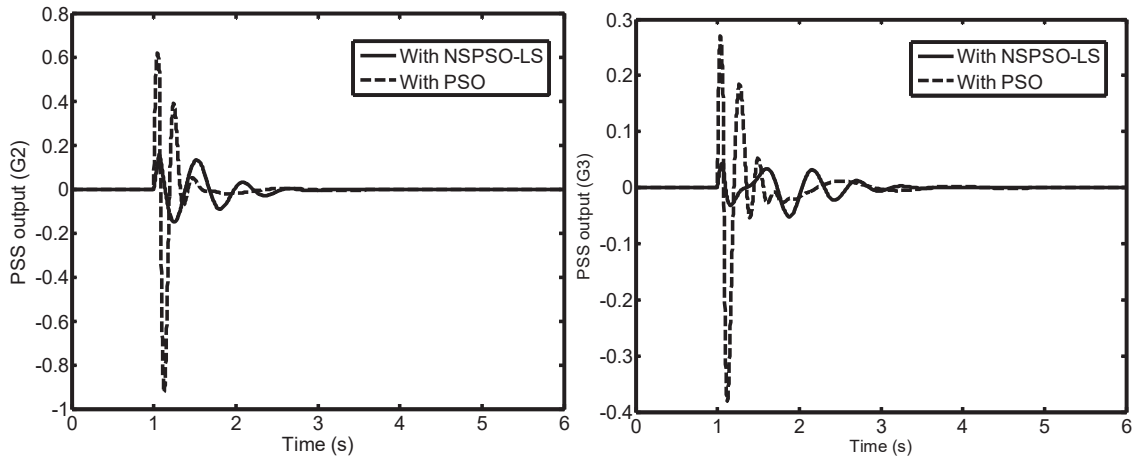

Fig. 7 PSS output for nominal load

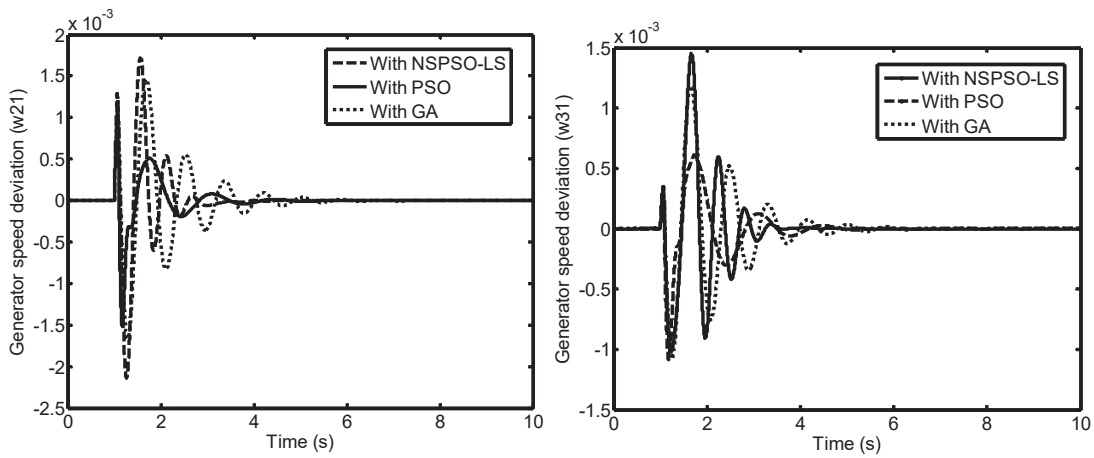

Fig. 8 PSS output for light load

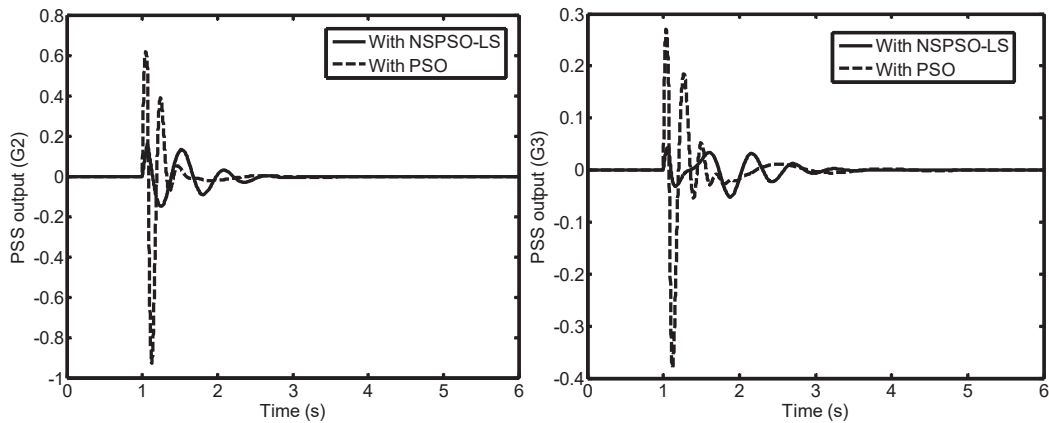

Fig. 9 PSS output for heavy load

VII. CONCLUSION

In this study, an improved version of NSPSO-LS is presented for improvement of power system stability. A non-dominated sorting concept with local search is incorporated in the selection phase. Two eigenvalue-based objective functions

are used to shift the electromechanical modes into a pre-specified zone in the s-plan. Eigenvalue analysis and nonlinear simulations for the 3-machine 9-bus system have demonstrated the effectiveness and robustness of the proposed stabilizer over a wide range of loading conditions and under

severe fault.

[22] P. M. Anderson, and A. A. Fouad, "Power system control and stability," Iowa, USA: Iowa State University Press, 1997.

ACKNOWLEDGMENT

This research work was supported by University of Hail, Saudi Arabia.

REFERENCES

- [1] P. Kundur, *Power System Stability and Control*, McGraw-Hill, 1994.
- [2] M. Kashki, Y. L. Abdel-Magid, and M. A. Abido, "Parameter optimization of multimachine power system conventional stabilizers using CDCARLA method," *Electrical Power and Energy Systems*, vol. 32, pp. 498-506, 2010.
- [3] D. R. Ostojic, "Stabilization of multimodal electromechanical oscillations by coordinated application of power system stabilizers." *IEEE Trans Power Syst*, vol. 6, no. 4, pp. 1439-1445, 1991.
- [4] C. T. Tse, K. W. Wang, C. Y. Chung, and K. M. Tsang, "Robust PSS design by probabilistic eigenvalue sensitivity analysis." *Electr Power Syst Res*, vol. 59, no. 1, pp. 47-54, 2001.
- [5] M. A. Abido, "Robust design of multimachine power system stabilizers using simulated annealing." *IEEE Trans Energy Conv*, vol. 15, no. 3, pp. 297-304, 2000.
- [6] H. Werner, P. Korba, and C. T. Yang, "Robust Tuning of Power System Stabilizers Using LMI-Techniques," *IEEE Trans on Control Syst Technol*, vol. 11, no. 1, pp. 147-152, 2003.
- [7] M. Ataei, R. A. Hooshmand, and M. Parastegari, "A wide range robust PSS design based on power system pole-placement using linear matrix inequality." *J Electr Eng*, vol. 63, no. 4, pp. 233-241, 2012.
- [8] S. J. Kim, S. Kwon, and Y. H. Moon, "Low-order robust power system stabilizer for single-machine systems: An LMI approach." *Int J Control Automat and Syst*, vol. 8, no. 3, pp. 556-563, 2010.
- [9] K. Sebaa, and M. Boudour, "Optimal locations and tuning of robust power system stabilizer using genetic algorithms" *Int J Electr Power Syst Res*, vol. 79, no. 2, pp. 406-416, 2009.
- [10] L. H. Hassana, M. Moghavvemi, H. A. F. Almurib, K. M. Muttaqi, and V. G. Ganapathy, "Optimization of power system stabilizers using participation factor and genetic algorithm," *Electr Power and Energy Syst*, vol. 55, pp. 668-679, 2014.
- [11] D. K. Sambariya, R. Gupta, and R. Prasad, "Design of optimal input-output scaling factors based fuzzy PSS using bat algorithm," *Engineering Science and Technology, an International Journal*, vol. 19, pp. 991-1002, 2016.
- [12] M. M. Beno, N. A. Singh, M. C. Therase, and M. M. S. Ibrahim, "Design of PSS for damping low frequency oscillations using bacteria foraging tuned non-linear neuro-fuzzy controller," *Proc. of the IEEE GCC conference and exhibition*, 2011, 653-56.
- [13] S. Mishra, M. Tripathy, and J. Nanda, "Multimachine power system stabilizer design by rule based bacteria foraging," *Int J Electr Power Syst Res*, vol. 77, no. 12, pp. 1595-1607, 2007.
- [14] B. Zhao, and Y. J. Cao, "Multiple objective particle swarm optimization technique for economic load dispatch," *Journal of Zhejiang University Science*, vol. 6A, no. 5, pp. 420 - 427, 2005.
- [15] B. M. Alshammari, "Dynamic Environmental/Economic Power Dispatch with Prohibited Zones Using Improved Multi-Objective PSO Algorithm," *International Review of Electrical Engineering*, vol. 11, no. 4, 2016.
- [16] J. Kennedy, and R. Eberhart, "Particle swarm optimization," *Proc. IEEE Int Conference on Neural Networks*, pp. 1942 - 1948, 1995.
- [17] M. A. Abido, "Optimal Design of Power-System Stabilizers Using Particle Swarm Optimization," *IEEE Trans on Energy Conversion*, vol. 17, no. 3, 2002.
- [18] S. Panda, and N. P. Padhy, "Robust Power System Stabilizer Design using Particle Swarm Optimization Technique," *International Journal of Electrical and Computer Engineering*, vol. 3, no. 13, 2008.
- [19] K. Deb, A. Pratap, S. Agarwal, and T. Meyarivan, "A fast and elitist multiobjective genetic algorithm: NSGA-II," *IEEE Trans. on Evolutionary Computation*, vol. 6 no. 2, 2002, pp. 182 - 197.
- [20] C. S. Tsou, S. Chang, and P. Lai, "Using crowding distance to improve multi-objective PSO with local search," *In-Tech Education and Publishing*, 2007.
- [21] M. Reyes-Sierra, and C. A. C. Coello, "Multiobjective particle swarm optimizers: a survey of the state-of-the-art," *International Journal of Computational Intelligence Research*, vol. 2 n0. 3, pp. 287 - 308, 2006.