

Digital Control Algorithm Based on Delta-Operator for High-Frequency DC-DC Switching Converters

Renkai Wang, Tingcun Wei

Abstract—In this paper, a digital control algorithm based on delta-operator is presented for high-frequency digitally-controlled DC-DC switching converters. The stability and the controlling accuracy of the DC-DC switching converters are improved by using the digital control algorithm based on delta-operator without increasing the hardware circuit scale. The design method of voltage compensator in delta-domain using PID (Proportion-Integration-Differentiation) control is given in this paper, and the simulation results based on Simulink platform are provided, which have verified the theoretical analysis results very well. It can be concluded that, the presented control algorithm based on delta-operator has better stability and controlling accuracy, and easier hardware implementation than the existed control algorithms based on z-operator, therefore it can be used for the voltage compensator design in high-frequency digitally-controlled DC-DC switching converters.

Keywords—Digitally-controlled DC-DC switching converter, finite word length, control algorithm based on delta-operator, high-frequency, stability.

I. INTRODUCTION

THE digitally-controlled DC-DC switching converter is gaining wider attention for its obvious advantages, such as the flexibility to implement complicated control strategies and algorithms, the programmability to realize reconfigurable power system, faster design process, high power conversion efficiency, robustness to noise, and insensitivity to parameter drifts of components. Not only can dynamically manages the system power supply, the digitally-controlled DC-DC switching converter can also realize the digital cycle feedback control inside the power and increase its performances consequently [1], [2].

The voltage compensator is a key part of the digitally-controlled DC-DC switching converter, which is designed based on the output voltage feed-back loop [3], [4]. There are lots of digital control algorithms for the voltage compensator, such as digital PID control, incomplete differential control algorithm [5], fast P processing plus IIR filter control method [6], digital fast P slow ID control [7], current feed-forward DC-DC digital control algorithm [8] and so on. Traditionally, the z-domain discrete model is used to describe the digital control algorithms, and the transfer function of digital compensator is obtained by z-transform. However, algorithms

described by z-domain model have inherent defects for the high-frequency digitally-controlled DC-DC switching converters [9].

With the increase of switching frequency of DC-DC converters, the performances of system based on the z-domain discrete model will be degraded. Firstly, the z-domain discrete model does not converge to its corresponding s-domain continuous model, which will decrease the controlling accuracy of the system. Secondly, the poles and zeros of the transfer function in z-domain are closing to the unit circle, as shown in Fig. 1, which degrade the stability of system. Thirdly, the distances between zeros and poles are becoming shorter, which will increase the sensitivity of poles to the finite word length of controlling coefficients, so even very little variation in controlling coefficients can cause the poles moving to the outside of the unit circle of z-plane. Those defects will impact the accuracy and stability of digitally-controlled DC-DC switching converters seriously.

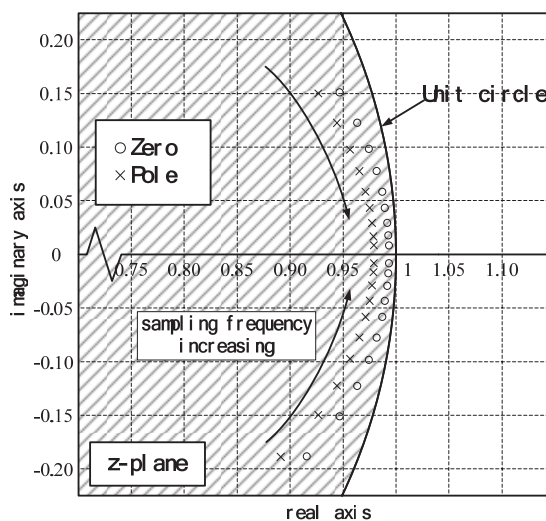

Fig.1 Moving of pole and zero of transfer function in z-domain when sampling frequency is increased

The delta-operator was proposed by Richard Middleton and Graham Goodwin in the 1980s [10]. It has been proved that for high sampling frequency, the properties of system based on delta-domain model converges to the corresponding s-domain continuous model [11], and the stable region of the system tends to the entire left half delta-plane. In addition, since the poles are insensitive to the controlling coefficients, the little variations in the coefficients will not affect the stability of the system, so there is no need for very high bit-width registers to

This work is supported by the National Natural Science Foundation of China (No. 61376034), Shaanxi province science and technology innovation project (No. 2015KTZDGY03-03) and Graduate Starting Seed Fund of Northwestern Polytechnical University (No.Z2016030).

Wei Tingcun and Wang Renkai are with the School of Computer Science and Technology, Northwestern Polytechnical University, Xi'an, China (e-mail: weitec@nwpu.edu.cn, 554279578@qq.com).

store these coefficients, thus the control algorithm based on delta-operator can reduce the complexity of circuit and reduce the area of controlling chip. This is a good solution for the problem appeared in z-domain when the sampling frequency is very high.

In this paper, a digitally-controlled buck DC-DC switching converter system is built in MATLAB platform. The PID control algorithm is adopted for the voltage compensator design of this system in continuous domain, and a stable delta-domain control algorithm is obtained by the transformation between s-domain and delta-domain. In the case of high sampling frequency, considering the limited word length characteristics for hardware implementation, the simulation and experimental results show that the DC-DC switching converter using delta-operator has the good stability and accuracy.

The structure of this paper is as follows. In Section II, the overview of delta-operator is introduced, and the realization of voltage compensator in delta-domain is given, including the structure of hardware circuit. In Section III, the experimental results are provided to verify the theoretical analysis results. The conclusion is given in Section IV.

II. THE CONTROL ALGORITHM BASED ON DELTA-OPERATOR FOR DC-DC CONVERTER

A. Delta-Operator

The delta-operator is also called as incremental difference operator and it is defined as:

$$\delta = \frac{z-1}{T} \tag{1}$$

where T is the sampling cycle (the inverse of sampling frequency), and z^{-1} is the backward shift operator.

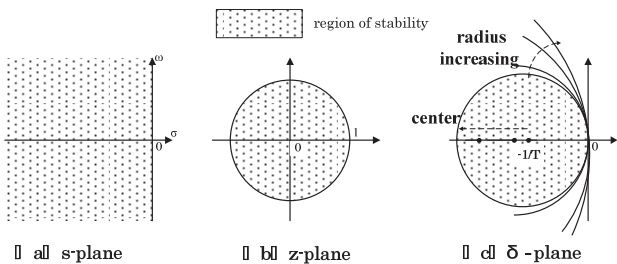

Fig. 2 Relations among s-plane, z-plane and delta-plane

For a stable continuous system, the real part of its conjugate complex pole ($s=\sigma\pm j\omega$), σ , must be less than 0, that means that the stable region is located in the left half plane of the s-plane, as shown in Fig. 2 (a). In this case, the magnitude of the poles in the discrete z-domain ($|z|=e^{\sigma T}$) should be less than 1, and the stable region is located within the unit circle of z-plane, as shown in Fig. 2 (b). From (1), it can be seen that, in the delta-plane, the stable region is still a circle, but the center of it is located at $(-1/T, 0)$, and the radius of it is equal to $1/T$, as shown in Fig. 2 (c). With the increase of sampling frequency, the stable region in the delta-plane is changed as follows: The

center is moving along the negative direction of the real axis, and the radius is increasing, namely the stable region is full of the whole left half plane. Therefore, with the increase of sampling frequency the discrete delta-domain model converges to the corresponding continuous s-domain model. The digital control algorithm based on delta-operator provides a new feasible control scheme for high-frequency digitally-controlled DC-DC converters.

B. The Digital Compensator Design Based on Delta-Operator

Fig. 3 shows the configuration of a digitally-controlled buck DC-DC switching converter which consists of power stage and digital controller. The digital controller is composed of analog-to-digital converter (ADC), voltage compensator, and digital pulse-width modulator (DPWM). As shown in Fig. 3, v_g and v_o are the input and output voltage, respectively; $v_{ref}[n]$ is the digital reference voltage, and $d[n]$ is the digital duty ratio calculated by the voltage compensator; $d(t)$ is the analog pulse signal converted by DPWM from $d[n]$. Through the output buffer, the analog pulse signal $d(t)$ controls the power switches, S1 and S2, on or off, to regulate the output voltage. L and C are the power inductor and output filter capacitor, respectively, and R is the equivalent load resistor.

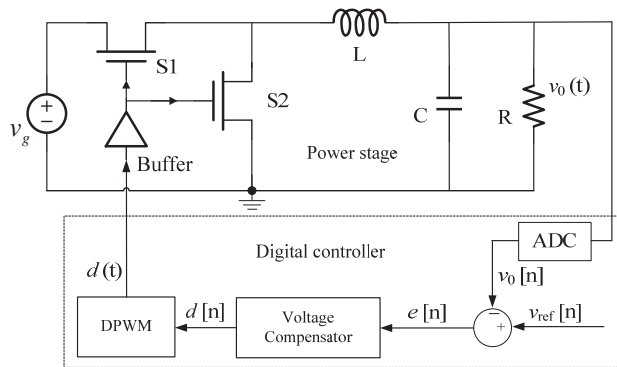

Fig. 3 Digitally-controlled buck DC-DC switching converter

For the voltage compensator with PID control algorithm, its continuous transfer function, $G_c(s)$, can be given as:

$$G_c(s) = K \frac{(1 + \frac{s}{w_{z1}})(1 + \frac{s}{w_{z2}})}{s(1 + \frac{s}{w_{p1}})} \quad (w_{p1} \neq 0) \tag{2}$$

where K is the gain of root locus (constant), w_{z1} , w_{z2} and w_{p1} are two zeros and one pole, respectively.

By setting reasonable positions of zeros and poles in (2), the good stability and the dynamic performances of the power system can be obtained. Usually, the first zero, w_{z1} , can be set at 1/2 to 1/4 of turning frequency of the controlled object to compensate for the negative effects of the PI controller. The second zero, w_{z2} , is such designed so as to cancel a pole of controlled object, thus can be configured at the turning frequency of the controlled object. On the other hand, in order

to suppress the high-frequency noise and ensure the system's Bode curve declining with the slope of -40dB/dec at high frequency, the pole, w_{p1} , can be set at high frequency domain. Based on above consideration, the zeros and pole of voltage compensator can be designed as:

$$w_{z1} = \frac{1}{2\sqrt{LC}} \quad (3)$$

$$w_{z2} = \frac{1}{\sqrt{LC}} \quad (4)$$

$$w_{p1} = (2^N - 1) f_s \quad (N = 2, 3, \dots) \quad (5)$$

where f_s is the switching frequency of DC-DC converter. The value of K should be chosen as a moderate value to make the tradeoff between the low-frequency gain and the phase margin.

To implement the digital control, the continuous transfer function of the voltage compensator should be converted into its discrete counterpart. By using the bilinear conversion, the equivalent discrete transfer function of the voltage compensator, $G_c(z)$, can be obtained from (2):

$$G_c(z) = \frac{az^2 + bz + c}{dz^2 + ez + f} \quad (6)$$

where a, b, c, d, e and f are the control coefficients of PID voltage compensator in z -domain, they have the definite relationship with w_{z1}, w_{z2}, w_{p1} and K in (2). Furthermore, by merging (1) and (6) we can get the transfer function of voltage controller in delta-domain, $G_c(\delta)$, as shown in (7):

$$G_c(\delta) = G_c(z) \Big|_{z = \frac{\delta-1}{\delta}} = \frac{a'\delta^2 + b'\delta + c'}{d'\delta^2 + e'\delta} = \frac{a' + b'\delta^{-1} + c'\delta^{-2}}{d' + e'\delta^{-1}} \quad (7)$$

where $a', b', c', d',$ and e' are the control coefficients of PID voltage compensator in delta-domain, they have the definite relationship with a, b, c, d, e and f in (6).

If the input and output of the compensator at k th cycle are defined as $e(k)$ and $u(k)$, respectively, since δ^{-1} in (7) is a delay factor, from (7) the relationship between the input and output of the compensator can be expressed as (8):

$$u(k) = D u(k-1) + A e(k) + B e(k-1) + C e(k-2) \quad (8)$$

where A, B, C and D are the control coefficients, they have the definite relationship with $a', b', c', d',$ and e' in (7).

Based on (8), the hardware circuit configuration of PID voltage compensator based on delta-operator can be obtained as shown in Fig. 4. Compared with the PID voltage compensator based on z -operator, the circuit scale is reduced significantly.

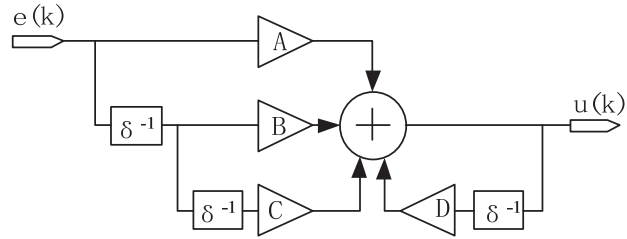

Fig. 4 Circuit configuration of PID voltage compensator based on delta-operator

III. SIMULATION RESULTS

To verify the effectiveness of the presented control algorithm based on delta-operator, a digitally-controlled buck DC-DC switching converter is built in MATLAB, which is based on the structure shown in Fig. 3. This DC-DC switching converter is operating in the continuous conduction mode (CCM), the parameters of the elements in the power stage are chosen as: $v_g=5.0$ V, $v_o=1.8$ V, $L=2.2$ μ H, $C=2.2$ μ F, $R=2\Omega$. By comparing the output voltage waveforms of the DC-DC converter based on z -operator and delta-operator, the advantages of delta-operator can be observed obviously.

Firstly, when the switching frequency of DC-DC switching converter is 1 MHz, and the fractional part of the control coefficients is digitized with 10-bits, the output voltage waveforms of the power system based on the z -, s - and the delta-operator are shown in Fig. 5. It can be seen that, for the steady-state values of output voltages, the systems based on delta-operator and s -operator have almost same value which is equal to 1.8 V theoretically, but the system based on z -operator has deviated value. Moreover, when the switching frequency is still 1 MHz, but the fractional part of the control coefficients is digitized with 7-bits, the output voltage waveforms of the power system based on the z -, s - and the delta-operator are shown in Fig. 6. In this case, the steady-state values of output voltages based on delta-operator and s -operator are same as that shown in Fig. 5, but that based on z -operator has seriously deviated value.

When the switching frequency of DC-DC switching converter is increased to 5 MHz, and the fractional part of the control coefficients is digitized with 11-bits and 7-bits, respectively, the output voltage waveforms of the power system based on the z -, s - and the delta-operator are shown in Figs. 7 and 8, respectively. It can be observed that, the steady-state values of output voltages can still controlled at the ideal value (1.8 V) if using delta-operator and s -operator, but which is seriously deviated from the ideal value (1.8 V) if using z -operator.

Simulation results show that, the controlling accuracy of voltage compensator based on delta-operator is considerably better than that of voltage compensator based on z -operator, when the switching frequency is increased and/or the number of bits of the control coefficients is decreased.

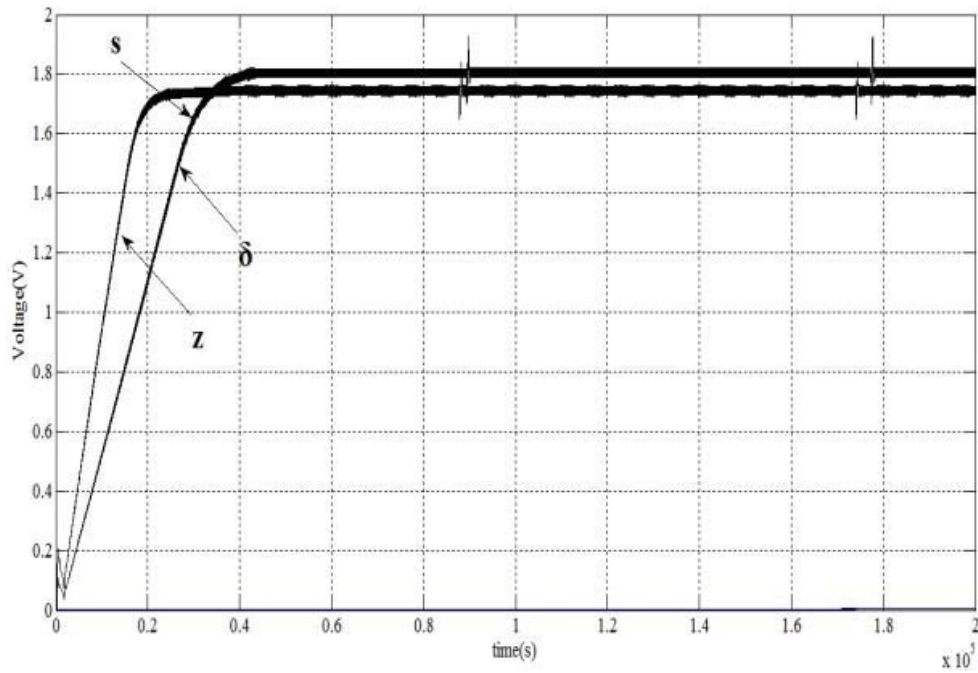

Fig. 5 Comparison of output voltage waveforms when the switching frequency is 1 MHz, and the fractional part is 10-bits

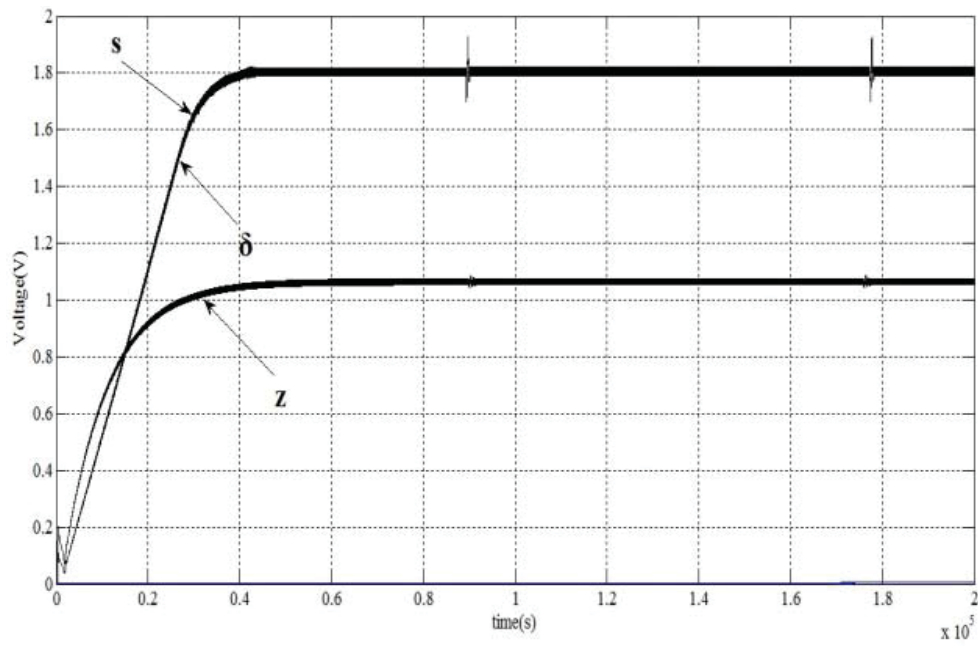

Fig. 6 Comparison of output voltage waveforms when the switching frequency is 1 MHz, and the fractional part is 7-bits

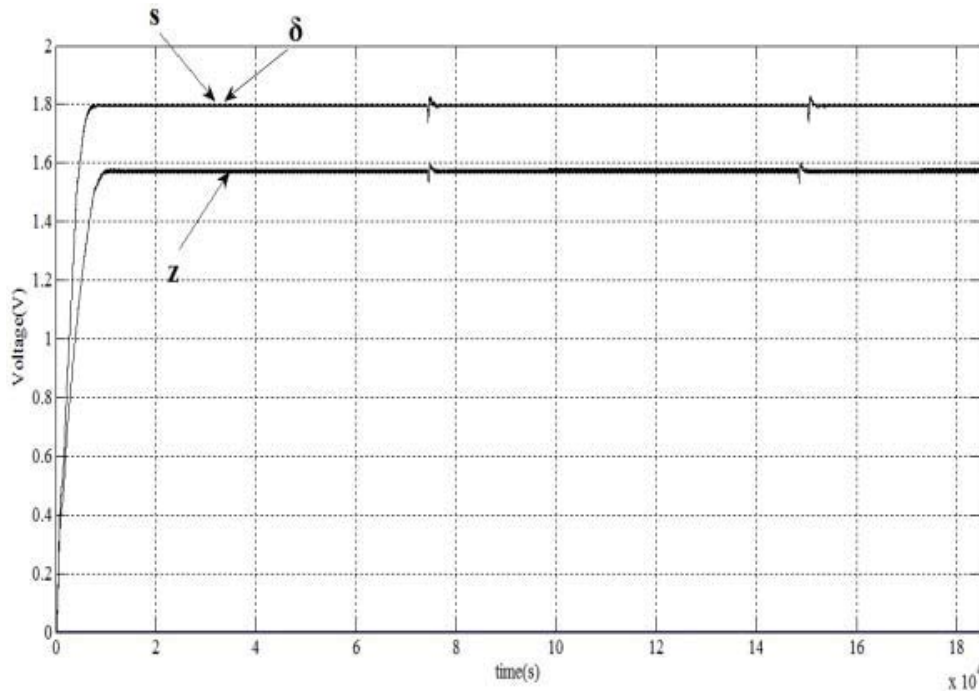

Fig. 7 Comparison of output voltage waveforms when the switching frequency is 5 MHz, and the fractional part is 11-bits

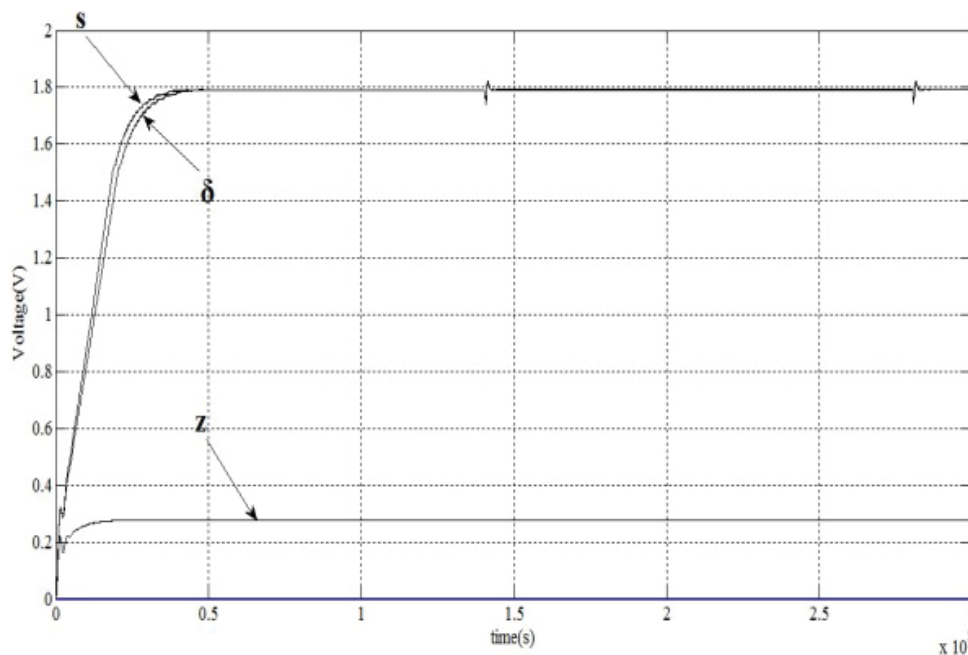

Fig. 8 Comparison of output voltage waveforms when the switching frequency is 5 MHz, and the fractional part is 7-bits

IV. CONCLUSION

In this paper, a digital control algorithm based on delta-operator, applied for the digitally-controlled DC-DC switching converters, has been presented. When the sampling frequency is high, the delta-operator provides a smooth transition from the discrete domain to the continuous domain. The design method

of digital voltage compensator for DC-DC switching converters in delta-domain is given, and its effectiveness is verified using Simulink platform simulation. Compared with z-domain discrete model, using the digital control algorithm based on delta-operator can upgrade both the stability and the controlling accuracy of the DC-DC switching converters obviously, and in addition, it is easily implemented by hardware circuit.

Therefore, it can be used for the design of digital voltage compensator, and it is especially useful for the design of high-frequency digitally-controlled DC-DC switching converters.

REFERENCES

- [1] C. Shi., B. C., Walker., et al., "A highly integrated power management IC for advanced mobile applications," IEEE Journal of Solid-State Circuits, vol. 42, pp. 1723-1731, 2007.
- [2] Tao Zhou; Jianping Xu; Francois, B., "Analog-to-digital converter architectures for digital controller of high-frequency power converters," IEEE Industrial Electronics, IECON 2006 - 32nd Annual Conference on, pp.2471-2476, Nov. 2006.
- [3] M. F. N. Tajuddin, N. A. Rahim, I. Daut, et al., "State space averaging technique of power converter with digital PID controller," in TENCON 2009 - 2009 IEEE Region 10 Conference, pp. 1-6, 2009.
- [4] F. Kurokawa, Y. Maeda, Y. Shibata, et al., "A new fast digital PID control dc-dc converter," in Power Electronics and Motion Control Conference (EPE/PEMC), 2010 14th International, pp. S13-15-S13-19, 2010.
- [5] Qian Long-jun, Guo Zhi, "On Satisfactory Control of Continuous Time Systems with Delta Operator induced Discrete Models", Control and Decision, Dec. 2005.
- [6] Ji Zhi-cheng, Zhao Wei-yi, Xie Lin-Bo, "Optimal Control of Networked Control System Using DOperator", Control and Decision, Vol. 21 No. 12, Dec. 2006
- [7] Hori. N, Mori. T, "A New Perspective for Discrete Time Models of a Continuous Time System," IEEE Trans. Automat. Contr., 1992, AC-37 (7: 1013-1017).
- [8] Permaratne. K, July. K. I, "tabular Method for Determining Root Distribution of Delta Operator Formulated Real Polynomials," IEEE Tran. Automat. Contr., 1994, AC-39(2): pp. 352-355.
- [9] Li Hui-guang, Wu Bo, Li Guo-you, et al. Delta operator control and its robust control theory basis (M). Beijing: National Defense Industry Press, 2005.
- [10] Middleton R H, Goodwin G C. Improved Finite Word Length Characteristics in Digital Control Using Delta Operators (J). IEEE T rans on Automatic Control, 1986, 31(11): 1015-1021.
- [11] Middleton R H, Goodwin G C. Digital Control and Estimation: A Unified Approach (M). NJ: Prentice Hall, 1990