

Improving Load Frequency Control of Multi-Area Power System by Considering Uncertainty by Using Optimized Type 2 Fuzzy PID Controller with HS Algorithm

Mehrdad Mahmudizad, Roya Ahmadi Ahangar

Abstract—This paper presents the method of designing the type 2 fuzzy PID controllers in order to solve the problem of Load Frequency Control (LFC). The Harmony Search (HS) algorithm is used to regulate the measurement factors and the effect of uncertainty of membership functions of Interval Type 2 Fuzzy Proportional Integral Differential (IT2FPID) controllers in order to reduce the frequency deviation resulted from the load oscillations. The simulation results implicitly show that the performance of the proposed IT2FPID LFC in terms of error, settling time and resistance against different load oscillations is more appropriate and preferred than PID and Type 1 Fuzzy Proportional Integral Differential (T1FPID) controllers.

Keywords—Load Frequency Control, Fuzzy-PID controller, Type 2 fuzzy system, Harmony Search algorithm.

I. INTRODUCTION

LFC is a very important component in the performance of the power system and the control of a safe and high-quality electricity generation and distribution [1], [2]. Large power systems are usually consisted of control areas or regions indicating integrated groups of generator. Different areas are connected to each other through communication lines. Communication lines are used for exchanging the conventional energy between areas. Changes in the load of the area and unnatural conditions will lead to an incompatibility between the frequency and exchanges of the planned power. This incompatibility must be corrected by LFC which acts as the regulation of generators' power output in the determined area [3]. Such a regulation means the maintenance of the planned system's frequency in the predetermined limits in response to changes in the system's frequency and loading of the communication lines. Key hypotheses in the classic LFC include [4], [5].

1. The frequency error resulted from the change of load must be corrected. The unstable frequency and time errors must be slight.
2. The static change in the line's power following the stepwise change of load in any area must be zero, if each area is able to match its load change.
3. Each area which requires the power in the necessary conditions must receive assistance from other areas.

The strategy of conventional control for LFC problem is the integration of the control error as the control signal. The integral controller is accompanied by the zero steady-state frequency deviation, but shows a weak dynamic performance [5], [6]. In order to improve the unstable response, different control techniques were provided. For LFC in a power system, different researches have been conducted, each of which proposed a strategy for the better control of the production process and increase of the reliability. For example, in [7], PI^2 controller was proposed as a solution for LFC. In [8]-[10], the controller was used for LFC. In [8], [9], the imperial competition algorithm and bacterial Foraging Optimization algorithm were used, respectively. In [10], the optimization process was defined in terms of a multi-objective function and was conducted by the bee colony algorithm. In [11], another type of PID parallel controller with 2 degrees of freedom was used. Finally, the Differential Evolution Algorithm was used for designing.

Some other researchers believe that a power system is a completely linear system with a high degree and the subject of LFC must be considered as a nonlinear problem. One of the widely used methods in the non-linear problems is using fuzzy controllers. In [12], [13], the fuzzy logic was used for solving the LFC problem. In [14], the Fuzzy-PI combined controller was used for solving the LFC problem. As mentioned above, the multi-area power system includes areas connected to each other by high-voltage communication lines or communication lines and the measured frequency current in each control area is the flow index of disproportionate power in the communication line, not only in the control area [15]. In the decentralized power system, the area frequency and the power exchanges of the communication line will change with the random change of the power load. Thus, objectives of LFC include the reduction of these variables' deviation and insuring that there is no steady-state error (steady-state error is zero). When LFC problem of the power systems is considered, the external unexpected oscillations, the parameter uncertainty and the model's variable connections provide challenges for the controller's design. Due to the complexity and multivariate condition of the power system, the conventional control methods do not provide successful solutions in multi-area power systems. When the analysis of approaches by

Roya Ahmadi is with the University of Science and Technology of Mazandaran, Iran, Islamic Republic Of (e-mail: roya_ahmadi_h@yahoo.com).

²Proportional Integral

conventional mathematical techniques is complex, the fuzzy logic controller is a very appropriate substitute for the conventional control methods. Mutually, the features of reliability and seriousness in fuzzy controllers make them appropriate for solving the control problems in power systems. Fuzzy control techniques were used in LFC problem and desired results were obtained [2], [6].

So far, most of the fuzzy logic applications were related to Type 1 Fuzzy Logic System (T1FLS). However, type 1 fuzzy logic controller (FLC) with type 1 membership functions is sometimes inadequate for the direct elimination of uncertainty. For solving this problem, type 2 fuzzy sets (T2FLS¹) as an expansion of T1FLS were introduced by Zadeh [16]. In comparison with T1FLS, Type 2 Fuzzy Logic System (T2FLS) eliminates the uncertainty in the words. Membership functions in type 2 fuzzy sets are 3D and include the effect of Footprint of Uncertainty (FOU) which the new third dimension is type 2 fuzzy sets. As a result, FOU provides more freedom which makes the possibility of direct design and elimination of uncertainty a better method compared to type 1 fuzzy sets. Consequently, fuzzy logic controls (FLCs) which use type 2 fuzzy sets for showing FLC inputs and outputs can eliminate the short-term and long-term uncertainty in order to reach a better performance [17]-[19].

The fuzzy logic system (FLS) defined at least with one type 2 fuzzy set is called T2FLS. Performances of type 2 fuzzy systems depend on computations more than type 1 systems. It made researchers to look for ways of reducing the high computational load in order to use T2FLS in the real world. Therefore, type 2 fuzzy sets were introduced as interval [20], [21]. The advantage of type 2 fuzzy sets compared to type 1 fuzzy sets is an interval in the display of FLC's input or out [22]. In this paper, interval type 2 PID controllers (IT2FPID) were introduced as the frequency controllers because the power system is a complex and large system with a high uncertainty. As a result, for the optimization of controller parameters, IT2FPID for the first time was used as FOU regulation method in HS optimization papers. In the next sections, we will show that the higher degree of freedom of reference IT2-FS² provides an opportunity for HS method to have a better performance compared to type 1 Fuzzy PID controllers and optimization common PID considering the performance index integral of time absolute error (ITAE). As a result, for two inputs of IT2PID which are error and error change and total numbers which must be optimized for IT2FPID's design, it is clear that IT2FPID has three parameters as additional degrees of freedom. The multi-area power system includes different areas and consequently each area must have one controller which in this study, the controller is type IT2FPID. As the number of optimization parameters for type 2 fuzzy controllers for multi-area power systems is relatively large, HS optimization method is an appropriate method due to its low computational expenses and high convergence (diversion) speed. In order to conduct a

correct comparison, measurement and rule-based factors for fuzzy controller's structure were considered fixed, while the only reference parameters for the power load request were optimized in the form of line-off.

The optimization results showed that IT2FPID which has more design parameters – given the performance index integral of time multiply absolute error (ITAE) – performs better than the structure of the conventional PID controller and optimized type 1 fuzzy controllers. As FOU creates a type 2 fuzzy set with a higher degree of freedom, it can be concluded that in IT2FPID, the performance of ITAE is lower than type 1 controllers (having similar measurement factors and rules). In other words, this additional degree of freedom makes it possible for HS total research method to provide a more appropriate response compared to the responses obtained from type 1 fuzzy PID and optimized PID. As a result, IT2FPID reduces the regulation time and frequency oscillations.

The rest of the discussion (paper) is divided into five sections. In Section II, a two-area interconnected power system is shown indicating a large and complex power system. Type 2 fuzzy controllers are mentioned in Section III. The structure of IT2FPID controller is mentioned and HS optimization algorithm used for the regulation of FLC type 2 membership functions is shown. In Section V, for showing the effect of the proposed integrated method, simulations are provided. The performance of IT2FPID controllers is compared with type 1 fuzzy PID controllers (T1FPID) and common PID controllers.

II. LOAD CONTROL: FREQUENCY IN A TWO-AREA SYSTEM

A two-area power system is composed of discrete areas which are connected to each other using communication lines with a high voltage level. The frequency diversion in each area of a multi-area system is not only the result of load changes, but also is affected by changes in the inter-area lines' transmitted power. As a result, controlling the frequency load in each area must not only control the frequency in the area, but also is responsible for controlling the lines' transmitted power. Therefore, the effect of inter-area lines must be considered in modeling FLC loop in an area. In Fig. 1, a two-area system is shown. In this figure, the relationship between the power passed the line between two areas is obtained through (1) [23]:

$$P_{tie} = \frac{V_1 V_2}{X_{12}} \sin(\delta_1 - \delta_2) \quad (1)$$

where, V_1 and V_2 are voltages of control areas 1 and 2, δ_1 and δ_2 are equivalent machines angles for areas 1 and 2 and X_{12} is the reactance of inter-area line. By linearization of (1) around the operating points δ_1° and δ_2° , we have:

$$\Delta P_{tie} = T_{12} (\Delta \delta_1 - \Delta \delta_2) \quad (2)$$

where, T_{12} is called the synchronization moment and obtained from (3):

¹Type 2 fuzzy sets

²Interval type 2-Fuzzy system

$$T_{12} = \frac{V_1 V_2}{X_{12}} \cos(\delta_1^0 - \delta_2^0) \quad (3)$$

Using $\frac{2\pi}{s} \Delta f = \Delta \delta$ transformation, we have:

$$\Delta P_{tie} = \frac{2\pi}{s} T_{12} (\Delta f_1 - \Delta f_2) \quad (4)$$

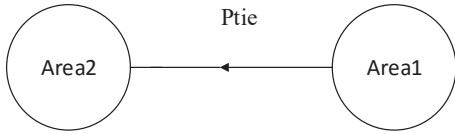

Fig. 1 Simple diagram of a two-area power system

In a multi-area system, in addition to the regulation of the area's frequency, the load-frequency control must reduce the diversion of the power which passed the inter-area lines into zero. This is done by adding a new signal to the feedback control loop. This signal is the diversion of the power which passed lines. An appropriate linear combination of the power

diversion and frequency diversion is defined as the Area Control Error (ACE) signal:

$$ACE = \Delta P_{tie} + \beta_i \Delta f_i \quad (5)$$

where, β_i is the bias coefficient of area i and obtained from:

$$\beta_i = \frac{1}{R} + D_i \quad (6)$$

Note that in the above relation, R is the drop characteristic and D is the coefficient of load's sensitivity to frequency changes.

The block diagram of this two-area power system with the nominal power of 2000 MW is shown in Fig. 2. For each area of Turbine and Governor's blocks with circuit, FLC was used separately. The effect of changes in the local load and the power passing the inter-area lines is shown in Fig. 2. Each control area controls its power passing the inter-area lines and area frequency in its control center. After the computation, the signal enters the controller. The produced control signal is applied in the desired Turbine Governor.

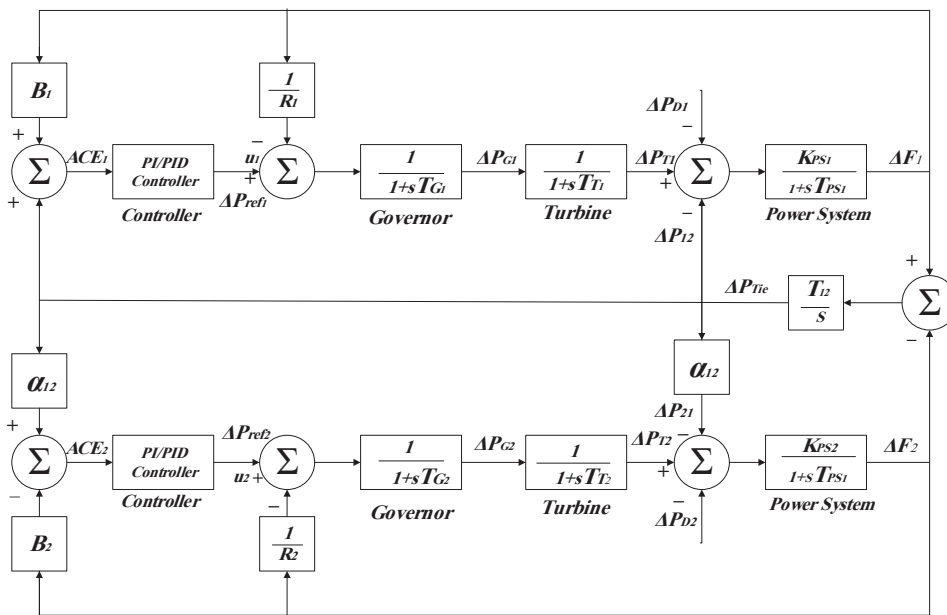

Fig. 2 Block diagram of a two-area power system

III. TYPE 2 FUZZY PID CONTROLLERS

The fuzzy logic is an appropriate method for designing robust systems which can provide an appropriate performance at the time of ambiguity and inaccuracy. Like type 1 fuzzy set (T1FS), the concept of type 2 fuzzy set (T2FS) was proposed by [16] following the ordinary fuzzy set. The FLS defined using at least one type 2 fuzzy set is a type 2 fuzzy logic. Type 1 fuzzy logics can directly eliminate the uncertainty in the rule because they use type 1 fuzzy sets which are not safe. In addition, type 2 fuzzy logics are very useful when the determination of an exact rule is difficult [21], [24]. Type 2

fuzzy sets (T2FS) are generalized forms of type 1 fuzzy sets and the identification of type 2 fuzzy sets is not as easy as that of type 1. In terms of mathematics, type 2 fuzzy set shown by \tilde{A} is determined by type 2 membership function $\mu_{\tilde{A}}(x, u)$ where $x \in X$ and $u \in J_X \subseteq [0, 1]$. For example, $(x, u) \leq 1$ and $0 \leq \mu_{\tilde{A}}$. \tilde{A} is defined as:

$$\tilde{A} = \{((x, u), \mu_{\tilde{A}}(x, u)) \mid \forall x \in X, \forall u \in J_X \subseteq [0, 1]\} \quad (7)$$

$$J_X \subseteq [0, 1]$$

$$\tilde{A} = \int_{x \in X} \int_{u \in J_x} \frac{\mu_{\tilde{A}}(x, u)}{(x, u)} \quad (8)$$

where, \int is the connection and continuity of all allowable u and x . J_x is the primary membership of x and $\mu_{\tilde{A}}(x, u)$ is type 1 fuzzy set known as the secondary set. Ambiguity in the primary membership \tilde{A} of type 2 fuzzy set is identified by an area called FOU which is the place of connection of all primary members. When for $\forall u \in J_x \subseteq [0, 1]$, we have $(x, \mu) = 1 \tilde{A} \mu$, the interval type 2 fuzzy set is obtained. Uniform shadows in FOU show the whole interval type 2 fuzzy set which can be explained based on the top membership function $(x) \bar{\mu}_{\tilde{A}}$ and the bottom one $(x) \underline{\mu}_{\tilde{A}}$ [21].

An example of the triangular type 2 fuzzy set is shown in Fig. 3. The primary membership J_x is shown in Fig. 3 (a) and other secondary members which are triangular and interval and shown in Figs. 3 (b) and (c), respectively. When the interval secondary membership function shown in Fig. 3 (c) is removed, an IT2FLS is obtained [21].

T2FLC diagram which is a special FLS is shown in Fig. 4. Like type 1 FLC, type 2 FLC includes fuzzification, inference and rules, and replaces defuzzification by processing the output. Type 2 FLC acts like type 1 FLC. Of course, in this

state, fuzzification collects new inputs and this input is totally fuzzified to type 2 fuzzy sets.

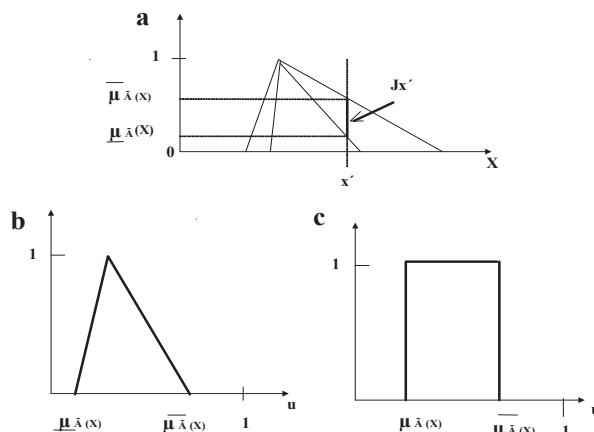

Fig. 3 (a) Type 2 fuzzy membership functions; (b) triangular secondary membership functions; (c) interval secondary membership functions

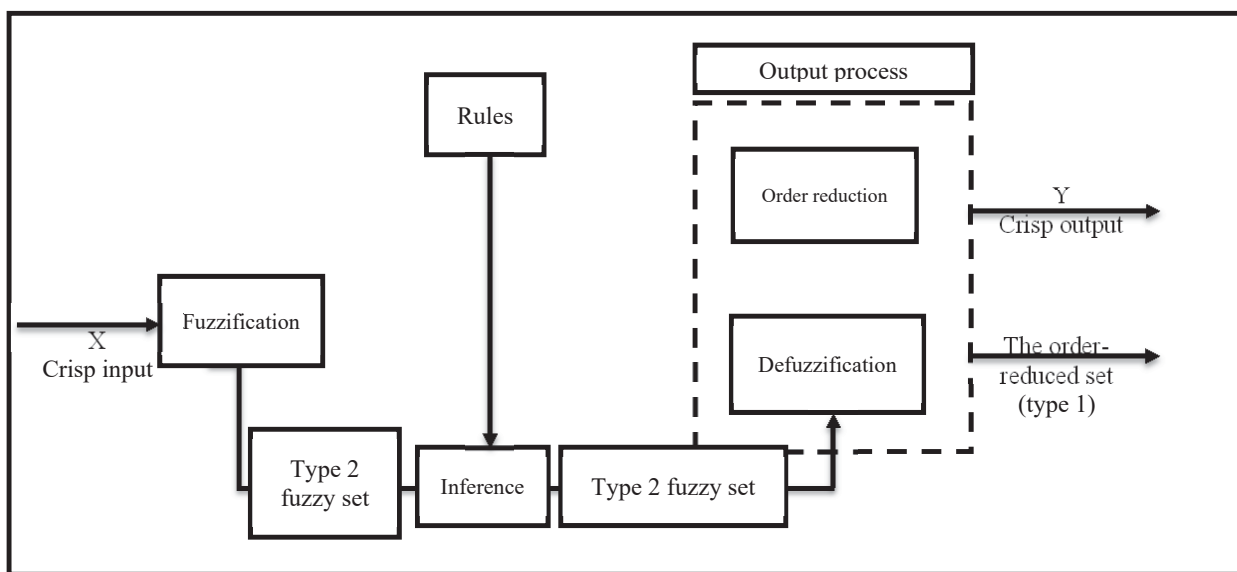

Fig. 4 Block diagram of type 2 fuzzy system

Type 2 FLC is determined by if-then rules, but the resulting reference fuzzy sets are of type 2. These outputs of type 2 fuzzy sets are processed by the order reduction which combine output sets and perform a series of central computations resulting in type 1 fuzzy set under the title of the order reduction. Defuzzification of type 1 fuzzy outputs defuzzifies the order reduction to produce new outputs [21].

A. Type 1 Fuzzy PID Controllers

PI and PID controllers are designed based on a linear model of power system under the loading condition. Despite the

relative ability of LFC in a determined operating point, in case of any change in the loading condition, it cannot provide an appropriate performance. Due to wide load changes in power systems, this controller lacks an exact performance and cannot respond to continuous changes. For solving this problem, non-linear methods such as fuzzy logic in LFC loop are proposed. In Fig. 5, Fuzzy-PID controller is shown. As shown in the figure, the input of fuzzy controllers is ACE and its derivatives, and their output determines the area's reference power changes.

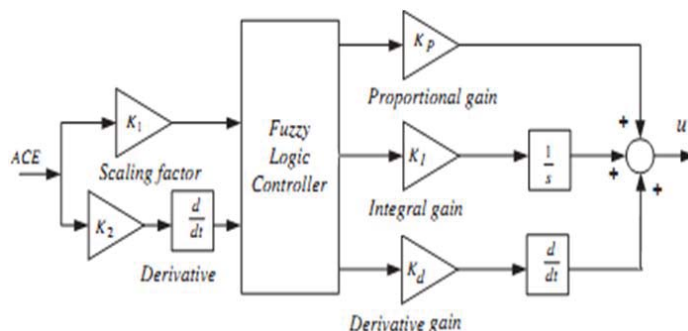

Fig. 5 Display of the Simulink model of the system under study with fuzzy controller

Membership functions of Fuzzy-PID controllers' input and output are shown in Fig. 6. Membership functions are triangular [25].

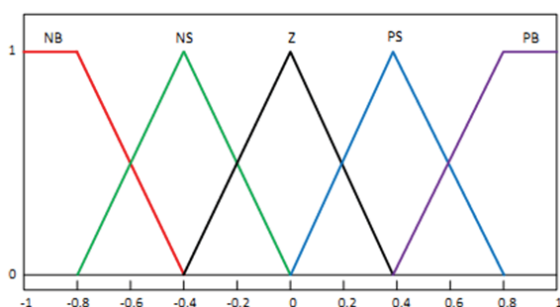

Fig. 6 Fuzzy controller's membership functions

In membership functions of Fig. 6, NB and NS show the large and small negative changes, respectively. Z is zero changes. In addition, for the positive section, PS and PB indicate the small and large positive changes, respectively. Fuzzy rules for Fuzzy-PID controller are shown in Table I.

TABLE I
FUZZY RULES FOR FUZZY-PID CONTROLLER

	ACE				
	NB	NS	Z	PS	PB
$\frac{d}{dt} ACE$	NB	NS	Z	PS	PB
	NS	NS	NS	Z	PS
	Z	NS	NS	Z	PS
	PS	NS	Z	PS	PB
	PB	Z	PS	PS	PB

B. Interval Type 2 Fuzzy Controllers

Performances of type 2 fuzzy systems are more involved in computations than type 1 systems. It made researchers to look for some ways to reduce this high computational level [20], [21].

The differentiation between type 1 and type 2 rules is related to the nature of membership functions. The structure of rules in type 2 exactly remains the same [26]. The reference Interval Type 2 Fuzzy Logic Control (IT2FLC) used in this study adopts interval type 2 fuzzy sets and the resulting part (outcome) is a single part which is the zero-order fuzzy set.

The *i*th fuzzy rule for PID fuzzy controllers of interval type 2 frequency load is as:

$$\text{If } ACE, \tilde{A}_{1i} \text{ \& } \Delta ACE: R_i \text{ rule } \tilde{A}_{2i} \\ \text{Then: } u=c_i \text{ \& } i=1, \dots, 9$$

where \tilde{A}_{1i} and \tilde{A}_{2i} are interval type 2 fuzzy sets and single c_i in interval type 2 FLC is the inference engine which combines rules and provides a design of input type 2 fuzzy sets to output type 2 fuzzy sets. Type 2 fuzzy outputs of the inference engine are then processed by order reduction which combines the output sets and performs a central computation from which type 1 fuzzy sets are resulted under the title "order reduction sets". Type-reducer fuzzy set in interval type 2 fuzzy model is expressed as $Y_{TR}=[Y_l, Y_r]$, where Y_{TR} is type 1 fuzzy set of order reduction which is determined by two endpoints of Y_l and Y_r . There are different methods for performing the order reduction in type 2 fuzzy systems [21], [27]. Karnik-Mendel's repetitive methods were used many times for the order reduction [28]. Wu [28] mentioned two features of Karnik-Mendel's model, i.e. innovation and compatibility. Innovation means that both top and bottom membership functions of a type 2 fuzzy set may (not) be simultaneously used in the computation of the order reduction set. Compatibility means that type-reducer interval set's connections will change with the change of inputs. So, the defuzzification by performing the defuzzification operation on the set $[Y_l, Y_r]$ and obtaining the type-reduced mean in order to achieve the fresh outputs forwarded to activators, computes the output variable of system Y [22], [29]. Different forms and types of membership functions can be selected for IT2PID inputs.

C. HS Optimization

In 2001, Zong Woo Geem proposed the HS algorithm which its layout was adopted from musicians' behavior in producing a piece of music. HS is a powerful search algorithm for finding an optimal answer. Since 2006, this algorithm attracted too much attention. In the music process, the musician starts to play the music and searches a better harmony. Based on his previous works, the musician attempts to play his best previous harmony or improve it. In addition, he can produce a new piece of music without having any prior experience about it. In the process of playing music without any prior experience, the musician can play any note in its

allowable distance and this note along with other notes produces a harmony vector. If the produced harmony is desirable, it is saved in the mind of the musician and increases the possibility of producing better harmonies in the next exercises and plays. The most important part in the HS is the harmony memory including a determined number of harmony vectors and each vector is the result of a play. The musician has three options for playing a note: he can play one of the existing notes in his memory, play a note similar to one of the existing notes in his memory or create a completely random note in the interval of allowable changes. In the HS algorithm, for producing a new vector of variables (harmony vector), the amount of each variable is determined based on one of the following three rules: A) Selection of one of the existing values in the memory; two harmonies, B) Selection of a value near one of the memory amounts; three harmonies, and C) Selection of a value for the variable from the allowable limit (out of memory) randomly; four harmonies. This algorithm includes five steps: Step 1- definition of an optimization problem and initialization of algorithm parameters. The optimization problem is in the form of minimization or maximization of the objective function $f(x)$ so that the problem algorithms are placed in the allowable limit. Furthermore, algorithm parameters which are initialized in this step include: 5 decisions variables (N) and their change intervals, harmony memory size (HMS), the probability of selecting a new variable from the memory (HMCR), the probability of modifying the variable selected from a memory with 6 harmonies (bw) and the completion criteria PAR(8) and the bandwidth of modifying 7 harmonies of the algorithm (the highest number of replications). Step 2- the initialization of the harmony memory. The initialization of the memory is completely random. The number of produced vectors is equal to the harmony memory size. The initial harmony memory is saved with corresponding values of the objective function [30].

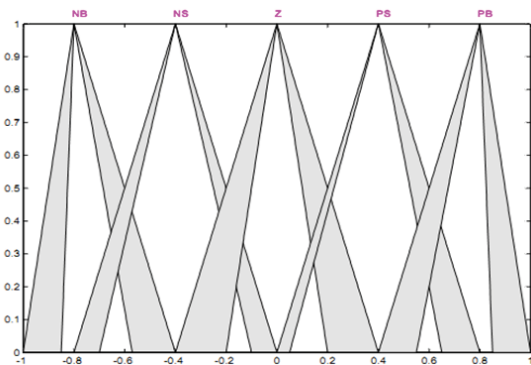

Fig. 7 The optimized type 2 fuzzy controllers' membership functions

IV. METHODOLOGY

LFC loop is very important in the utilization of power systems. Since the amount of load in a power system is continuously changing, we need a safe LFC system which have an appropriate performance in different operating conditions and can maintain the generator's power generation and power system's frequency in an allowable limit with a desired stability. For this reason, different controllers are used for achieving this purpose. Here, an important issue is the unpredictability of the amount of load or in other words, the uncertainty of load in the system. For solving this problem, in this thesis, type 2 fuzzy controller was used. Using this controller, this problem can be greatly solved provided that fuzzy controller's membership functions are correctly selected. For this reason, the HS algorithm is used for determining type 2 fuzzy controller's optimal points. After the optimal designing of controller, we used it in a two-area power system and the results obtained from simulation were compared with results of similar systems but with PI, PID and fuzzy controllers. For comparison, ITAE criterion was computed. It is worth mentioning that the less the criterion, the better the performance of controller in oscillations damping and it creates oscillations at minimum time with a minimum range.

$$ITAE = \int_0^{t_{sim}} (|\Delta f_1| + |\Delta f_2| + |\Delta P|) \times t^2 \quad (9)$$

where, Δf_1 and Δf_2 are frequency changes in areas 1 and 2, respectively and ΔP is the changes of power transferred between two areas. In addition, the operator t is time and t_{sim} is the simulation period. The less these two values, the better the performance of controller because it could damp the frequency oscillations at the minimum time with the minimum range. Parameters of this power system are provided in Table II.

TABLE II
PARAMETERS OF THE DESIRED NETWORK

P_R	2000MW	P_L	1000MW
F	60	B1=B2	0.045
R1=R2	2.4	$T_{G1}=T_{G2}$	0.08
$T_{T1}=T_{T2}$	0.3	$K_{ps1}=K_{ps2}$	120
$T_{ps1}=T_{ps2}$	20	T_{12}	0.545
12α	-1		

In addition to type 2 fuzzy controllers optimized in LFC loop, PI, PID and fuzzy controllers were also used in order to compare controllers' performance by comparing the simulation results.

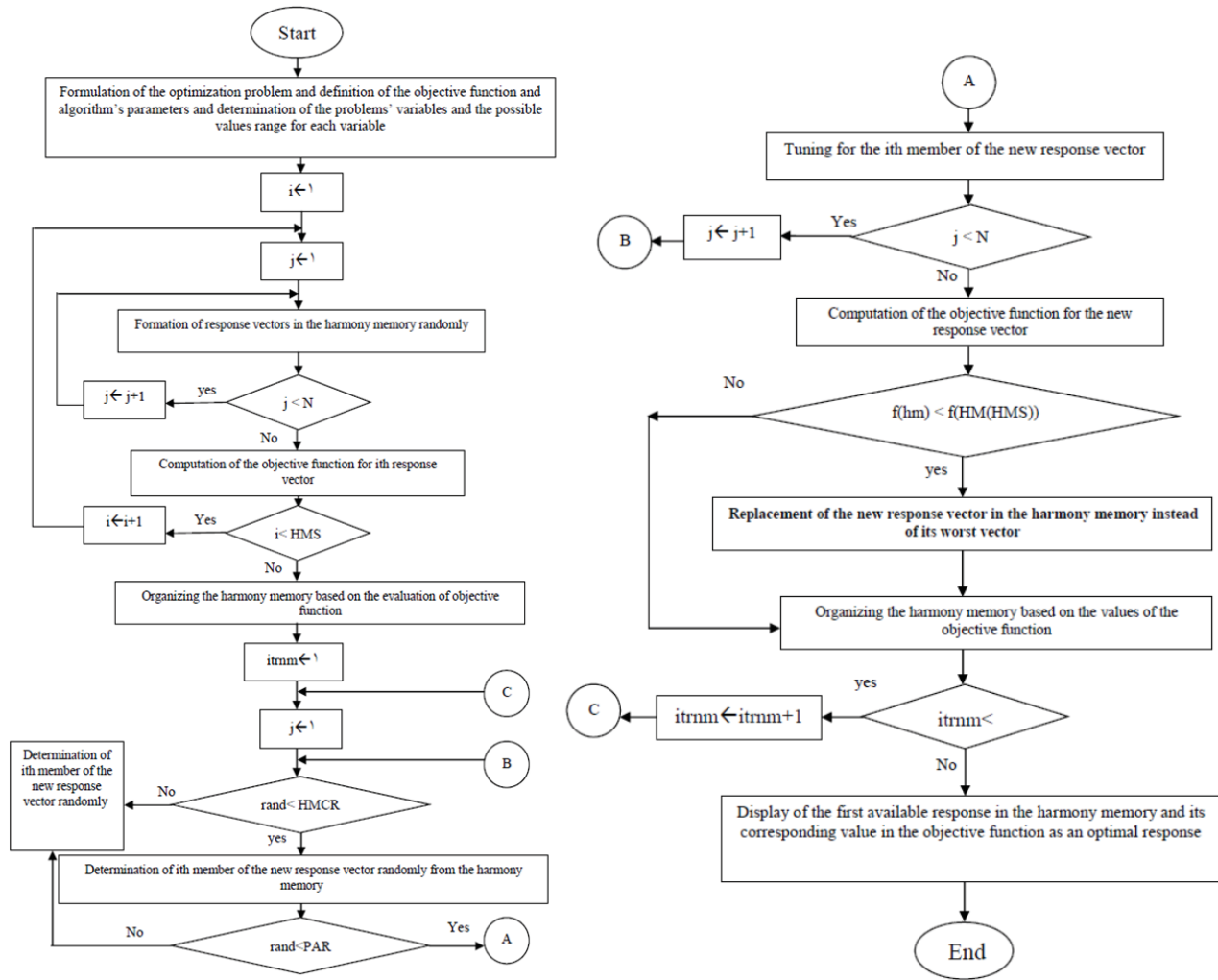

Fig. 8 HS algorithm

V.SIMULATION

For simulation, Matlab 2013 software has been used. For this reason, first, PI and PID conventional controllers in LFC loop were used. Parameters of these two controllers Table III [25].

TABLE III
PARAMETERS OF PI AND PID CONTROLLERS

Type of controller	P coefficient	I coefficient	D coefficient
PI controller	0.635	1	0
PID controller	0.8	0.635	0.18

PI and PID controllers are designed based on the linear model of power system under a determined loading condition. Despite the relative ability of LFC in a determined operating point, it cannot have an appropriate performance in case of a change in the load condition. Due to wide changes of load in power systems, these controllers do not have an exact performance and cannot respond to the continuous changes of load. For solving this problem, non-linear methods such as the

fuzzy logic in LFC loop are proposed. The exact designing of membership functions in a fuzzy system is very important. Because in case of an inappropriate design, this controller may deteriorate the situation and not only does not reduce the frequency changes, but also increases it. For designing membership functions, we can use the experiences of a skillful and specialized person in the area of system and or adopt intelligent algorithms in designing membership functions. In this thesis, the HS algorithm was used to find optimal membership functions in the fuzzy system. HS algorithm's parameters are summarized in Table IV.

TABLE IV
PARAMETERS OF HS ALGORITHM

Hms	Hmcr	Par	δ
30	0.9	0.3	2.1

After designing PI, PID and fuzzy controllers and optimized type 2 fuzzy controllers, the performance of each controller was evaluated in two situations. In the first situation, the load is changed in the first area and load changes in the second area

are equal to zero. In the second situation, contrary to the previous situation, load changes in the first area are equal to zero and in the second area we have load changes.

A. The First Scenario

In this situation, with load changes in the first area $\Delta P_{D1}=0.1$ and by fixing the load in the second area $\Delta P_{D2}=0$,

diagrams of frequency changes in the first area Δf_1 and second area Δf_2 and power changes in the communication line ΔP are obtained which are shown in Figs. 9-11.

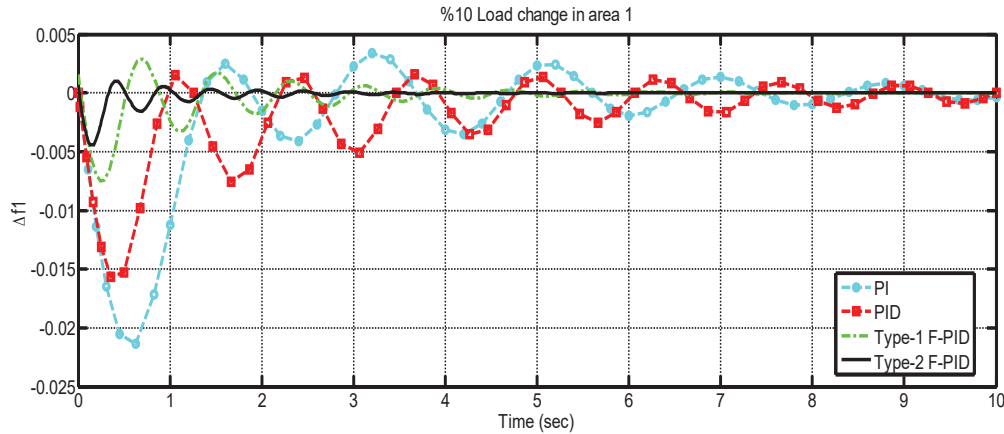

Fig. 9 Frequency changes in the first area in case of 10% load change in the first area

In Fig. 9 and next figures, the turquoise blue line with circular markers and red line with square marker are related to the system with PI controller and the system with PID controller, respectively. In addition, the green and black lines are results of type 1 fuzzy PID controllers and type 2 fuzzy PID controllers, respectively. As observed in the figure, PI and PID controllers have an inappropriate performance in damping the frequency oscillations in the first area. But, fuzzy controllers find frequency oscillations in the first area more quickly due to their high flexibility and compatibility with different working conditions. In Fig. 10, frequency changes in the second area are shown.

Like the first area, frequency changes in this area by the fuzzy controllers are less than conventional controllers and they removed frequency changes in a relatively short time. In the comparison of fuzzy controllers' performance, it can be mentioned that type 2 fuzzy controllers have a more appropriate performance than type 1. The oscillation range and oscillations' damping time in the power system with type 2 fuzzy PID controller are less than other controllers. Another diagram which can be used for the evaluation of the desired controller is the diagram of changes of power transferred between two areas. In Fig. 11, power changes in the communication line in case of load change in the first area are shown.

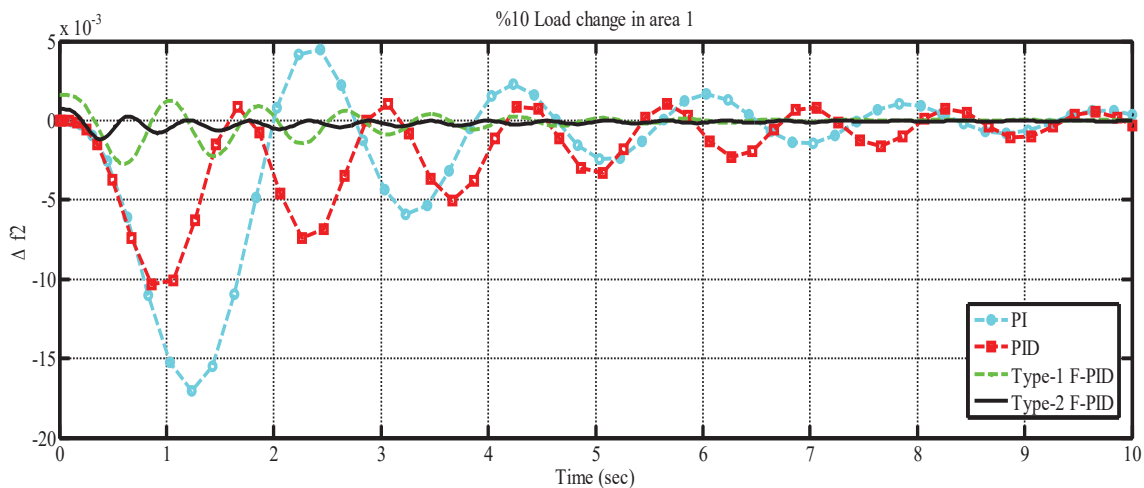

Fig. 10 Frequency changes in the second area in case of 10% load change in the first area

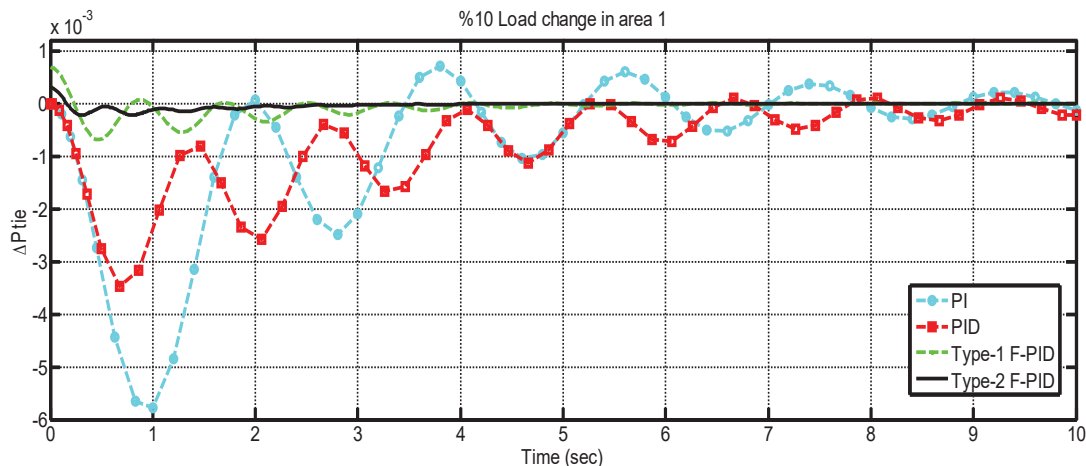

Fig. 11 Power changes in the communication line in case of 10% load change in the first area

Another diagram which can be used for the evaluation of the evaluation of the desired controller is the diagram of changes of power transferred between two areas. In case of a change in the power of one of these areas in a power system, the controller with the minimum power oscillations in the communication line of the power system has a better performance. By studying the results obtained from the simulation, the more accurate performance of non-linear fuzzy controllers is observed. In a power system which used fuzzy controllers, power oscillations in the communication line reached a minimum level. For the more accurate evaluation of results, ITAE criterion was computed for simulated systems. These results are shown in Fig. 12.

When ITAE criterion of a power system with PI controller is maximum 3.756 and this criterion for a power system with type 2 fuzzy PID controller is minimum 0.138, these numbers mean the better performance of type 2 fuzzy controllers. In Table V, values of settling time with the criterion of the maximum changes smaller than 4% are provided.

TABLE V
SETTLING TIME OF THE POWER CHANGE IN THE FIRST AREA

	Ts (sec)		
	Δf_1	Δf_2	ΔP_{tie}
PI	>10	>10	>10
PID	9.73	9.91	9.78
Type 1 Fuzzy PID	5.42	6.04	4.51
Type 2 Fuzzy PID	2.64	3.84	1.76

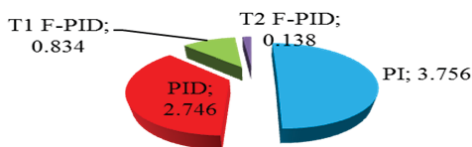

Fig. 12 ITAE criterion related to controllers in case of 10% load change in the first area

B. The Second Scenario

In this scenario, for assessing the performance of controllers, 10% power changes are applied in the second area and the power of first area was fixed.

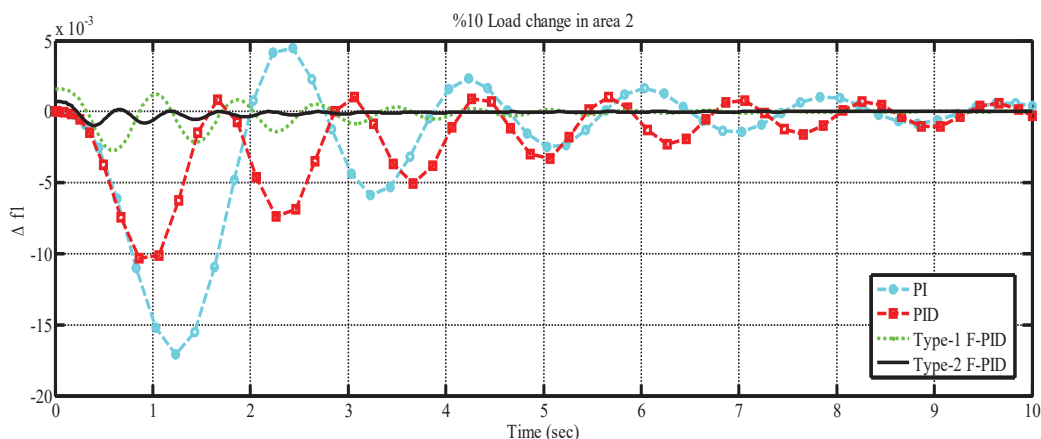

Fig. 13 Frequency changes in the first area in case of 10% load change in the second area

Given the obtained diagrams in Fig. 13, at the presence of fuzzy controllers, frequency oscillations in the first area were damped in the first area at the minimum time and minimum range compared to conventional controllers. Frequency oscillations in the first area were damped faster when they

used type 1 fuzzy instead of type 2. The amount of frequency changes related to a system with PI controller is very large and in case of more load changes, there is the possibility of load loss in the system. In Fig. 14, frequency changes in the second area are shown.

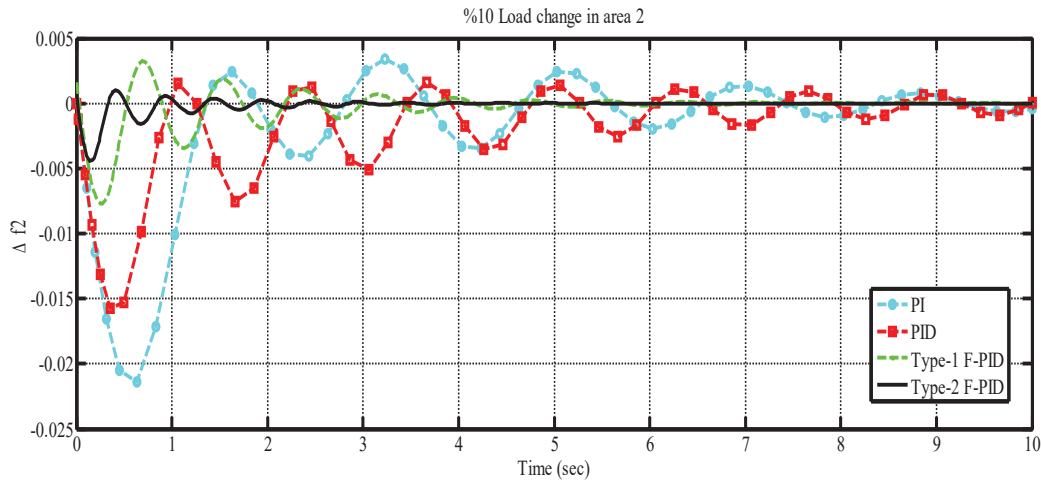

Fig. 14 Frequency changes in the second area in case of 10% load change in the second area

Based on Fig. 14, it can be mentioned that in case of using type 2 fuzzy controller, frequency changes in the second area have the minimum value and the system with PI controller has

the maximum oscillations. In Fig. 15, power changes in the communication line between two areas are shown.

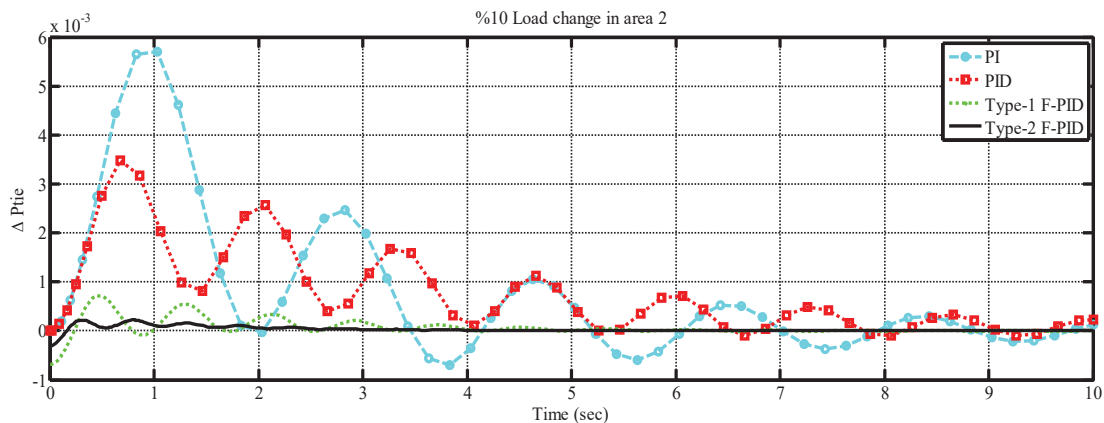

Fig. 15 Power changes in the communication line in case of 10% load change in the second area

Power changes in the communication line for a system in which PI controller is used have a very large range. The maximum changes are approximately 10 times the systems controller by the fuzzy logic. After studying the diagrams of frequency changes and power in the second scenario, the obtained results were studied. For this reason, ITAE related to each controller is shown in Fig. 16

By studying results obtained from Figs. 13-16, it can be concluded that type 2 fuzzy controller shows a better performance compared to other controllers and could maintain ITAE criterion at the minimum possible value. As mentioned before, the smaller value of this criterion indicates the rapid

damping and small oscillations range. In Table VI, settling time values in the second scenario are obtained.

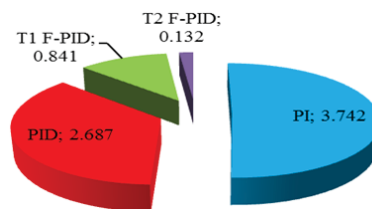

Fig. 16 ITAE criterion related to controllers in case of 10% load change in the second area

TABLE VI
SETTLING TIME OF THE POWER CHANGE IN THE SECOND AREA

	Ts (sec)		
	$\Delta f1$	$\Delta f2$	ΔP_{tie}
PI	>10	>10	>10
PID	>10	9.87	9.93
Type 1 Fuzzy PID	4.23	4.86	5.22
Type 2 Fuzzy PID	2.43	2.67	1.94

VI. RESULTS

In this paper, we studied the performance of designed controllers in the LFC system. First, the two-area power system model was modeled based on the information available at Matlab software environment and after designing controllers, they were used in the power system. The main part of the simulation process is related to type 2 fuzzy controllers which after the initial design, the optimal membership functions were obtained through HS algorithm and considering ITAE criterion as the objective function. For assessing the efficiency of controllers, the performance of controllers was tested in two situations. The second situation was contrary to the first one and the power of first area was fixed and that of the second area was variable. After the simulation, obtained results were studied. Results indicate the more appropriate performance of fuzzy controllers compared to conventional ones. But, among fuzzy controllers, type 2 fuzzy controllers have a relatively better performance. It is worth noting that the significant difference between type 1 and type 2 fuzzy systems is determined at the time of uncertainty. This uncertainty can be related to load changes or uncertainty in the membership functions and fuzzy logic rules and it can be the reason of better performance of type 2 fuzzy controllers compared to type 1.

REFERENCES

- [1] P. Subbaraj, K. Manickavasagam, Automatic generation control of multi-area power system using fuzzy logic controller, *European Transactions on Electrical Power* 18 (2008) 266–280.
- [2] C.S. Chang, W. Fu, Area load frequency control using fuzzy gain scheduling of PI controllers, *Electric Power Systems Research* 42 (2) (1997) 145–152.
- [3] N. Jaleeli, L.S. VanSlyck, D.N. Ewart, L.H. Fink, A.G. Hoffmann, Understanding automatic generation control, *IEEE Transactions on Power Systems* 7 (3) (1992) 1106–1112.
- [4] J. Talaq, F. Al-Basri, Adaptive fuzzy gain scheduling for load frequency control, *IEEE Transactions on Power Systems* 14 (1) (1999) 145–150.
- [5] O.I. Elgerd, *Electric Energy Systems Theory: An Introduction*, McGraw-Hill, Q4 1971.
- [6] E. Yesil, M. Guzelkaya, I. Eksin, Self-tuning fuzzy PID-type load and frequency controller, *Energy Conversion and Management* 45 (3) (2004) 377–390.
- [7] U. Kumar, R. Sahu, S. Panda, "Design and analysis of differential evolution algorithm based automatic generation control for interconnected power system", *Ain Shams Engineering Journal*, Vol. 4, pp.409–421, 2013.
- [8] Hamed Shabani, Behrooz Vahidi, Majid Ebrahimpour, cA robust PID controller based on imperialist competitive algorithm for load-frequency control of power systems", *ISA Transactions*, Vol.52, pp. 88-95, 2013.
- [9] E.S. Ali, S.M. Abd-Elazim, "BFOA based design of PID controller for two area Load Frequency Control with nonlinearities", *International Journal of Electrical Power & Energy Systems*, Vol.51, pp. 224-231, 2013.
- [10] K. Naidu, H. Mokhlis, A.H.A. Bakar, "Multiobjective optimization using weighted sum Artificial Bee Colony algorithm for Load Frequency Control", *International Journal of Electrical Power & Energy Systems*, Vol.55, pp. 657-667, 2014.
- [11] Rabindra Kumar Sahu, Sidhartha Panda, Umesh Kumar Rout, "DE optimized parallel 2-DOF PID controller for load frequency control of power system with governor dead-band nonlinearity", *International Journal of Electrical Power & Energy Systems*, Vol.49, pp. 19-33, 2013.
- [12] K. R. M. Vijaya Chandrakala, S. Balamurugan, K. Sankaranarayanan, "Variable structure fuzzy gain scheduling based load frequency controller for multisource multi area hydro thermal system", *International Journal of Electrical Power & Energy Systems*, Vol. 53, pp. 375-381, 2013.
- [13] H. A. Yousef, K. AL-Kharusi, M. H. Albadi, "Load Frequency Control of a Multi-Area Power System: An Adaptive Fuzzy Logic Approach", *IEEE Trans. on power system*, pp. 1-9, 2014.
- [14] O. Abedinia, M.S. Naderi, A. Ghasemi, "Robust LFC in deregulated environment: Fuzzy PID using HBMO", *The 10th international conference on Environment and Electrical Engineering (EEEIC)*, pp. 1-4, 2011.
- [15] H. Bevrani, M. Yasunori, T. Kiichiro, Sequential design of decentralized load frequency controllers using mu synthesis and analysis, *Energy Conversion and Management* 45 (6) (2004) 865–881.
- [16] L.A. Zadeh, The concept of a linguistic variable and its applicate to approximate reasoning-I, *Information Sciences* 8 (1975) 199–249.
- [17] N.N. Karnik, J.M. Mendel, Q. Liang, Type-2 fuzzy logic systems, *IEEE Transactions on Fuzzy Systems* 7 (6) (1999) 643–658.
- [18] P.Z. Lin, C.M. Lin, C.F. Hsu, T.T. Lee, Type-2 fuzzy controller using a sliding-mode approach for application to DC–DC converters, *IEE Proceedings – Electric Power Applications* 152 (6) (2005) 1482–1488.
- [19] S. Barkati, E.M. Berkouk, M.S. Boucherit, Application of type-2 fuzzy logic controller to an induction motor drive with seven-level diode-clamped inverter and controlled infeed, *Electrical Engineering* 90 (2008) 347–359.
- [20] Q. Liang, J.M. Mendel, Interval type-2 fuzzy logic systems: theory and design, *IEEE Transactions on Fuzzy Systems* 8 (5) (2000) 535–550.
- [21] J.M. Mendel, *Uncertain Rule-Based Fuzzy Logic: Introduction and New Directions*, Prentice Hall, USA, 2000.
- [22] H. Hagra, Type-2 FLCs: a new generation of fuzzy controllers, *IEEE Computational Intelligence Magazine* 2 (1) (2007) 30–43.
- [23] *Power System Operation and Control* by N. V. Ramana Professor and Head, Department of Electrical and Electronics Engineering, JNTU College of Engineering, Jagtial, Karimnagar (D), Andhra Pradesh
- [24] O. Castillo, L. Aguilar, N. Cázarez, S. Cárdenas, Systematic design of a stable type-2 fuzzy logic controller, *Applied Soft Computing* 8 (3) (2008) 1274–1279.
- [25] <http://www.matlabsite.com/4491/fvrp108-pid-tuning-using-fuzzy-logic-video-tutorial.html>.
- [26] M. Galluzzo, B. Cosenza, A. Matharu, Control of a nonlinear continuous bioreactor with bifurcation by a type-2 fuzzy logic controller, *Computers & Chemical Engineering* 32 (12) (2008) 2986–2993.
- [27] H. Wu, J.M. Mendel, Uncertainty bounds and their use in the design of interval type-2 fuzzy logic systems, *IEEE Transactions on Fuzzy Systems* 10 (5) (2002) 622–639.
- [28] D. Wu, An overview of alternative type-reduction approaches for reducing the computational cost of interval type-2 fuzzy logic controllers, in: *Proceedings of IEEE International Conference on Fuzzy Systems, FUZZ-IEEE'2012*, 2012, pp. 1–8.
- [29] C.F. Juang, C.H. Hsu, Reinforcement interval type-2 fuzzy controller design by online rule generation and q-value-aided ant colony optimization, *IEEE Transactions on Systems, Man, and Cybernetics, Part B: Cybernetics* 39 (6) (2009) 1528–1542.
- [30] Lee, K. S. and Geem, Z. W., (2005), "A New Meta-Heuristic Algorithm for Continuous Engineering Optimization: Harmony Search Theory and Practice," *Computer Methods in Applied Mechanics and Engineering*, 194, pp. 3902-3933.