

Active Vibration Control of Passenger Seat with HFPIDCR Controlled Suspension Alternatives

Devdutt, M. L. Aggarwal

Abstract—In this paper, passenger ride comfort issues are studied taking active quarter car model with three degrees of freedom. A hybrid fuzzy – PID controller with coupled rules (HFPIDCR) is designed for vibration control of passenger seat. Three different control strategies are considered. In first case, main suspension is controlled. In second case, passenger seat suspension is controlled. In third case, both main suspension and passenger seat suspensions are controlled. Passenger seat acceleration and displacement results are obtained using bump and sinusoidal type road disturbances. Finally, obtained simulation results of designed uncontrolled and controlled quarter car models are compared and discussed to select best control strategy for achieving high level of passenger ride comfort.

Keywords—Active suspension system, HFPIDCR controller, passenger ride comfort, quarter car model.

I. INTRODUCTION

SUSPENSION system is important part in vehicles from design and application considerations to fulfil multiple tasks such as vehicle handling as well as passenger ride comfort and safety during running period. Suspension systems can be categorized into passive, semi-active and active types [1]-[3]. Passive suspension systems are mostly used in automotive sector due to less cost and unavailability of latest active and semi-active type suspension technology. But passive suspension systems can provide limited performance related to vibration control under various road conditions. On the other hand, active suspension technology can provide best vehicle handling and passenger ride experience [4]. Active suspension is integrated with mechatronic based devices such as sensors and actuators.

In past, various linear and non-linear control algorithms have been used in quarter car model with active suspension system. Fialho and Balas [5] used the road adaptation factor where linear parameter-varying control was used in combination with nonlinear backstepping technique to design lower and higher level control for active quarter car suspension model. Simulation results showed the superior performance of adaptive suspension controllers in providing passenger ride comfort compared to passive one. Huang and Lin [6] proposed a neural network based sliding mode control for application in active quarter car suspension system. The proposed model had on-line learning ability to control the

uncertain behaviour of the system by varying the neural network parameters. The experimental results showed the superior performance of proposed controller in sprung mass vibration suppression compared to passive type against input road disturbances. Lauwerys et al. [7] used μ -synthesis based on the DK-iteration scheme to design controller for application in active suspension of a quarter car test-rig. The frequency domain identification technique was used for linear black box models identification. Simulated and experimental results on test-rig presented the desired performance of the system. Huang and Chen [8] proposed a functional approximation (FA) based adaptive sliding mode controller with AFSMC compensation (FA + AFSMC) strategy for vibration control in active quarter car system. The experimental results showed the superior performance of FA + AFSMC controller in sprung mass vibration control compared to fuzzy adaptive and sliding mode control. Mouleeswaran [9] used PID controller for improving passenger ride comfort and vehicle handling in active quarter car model. The simulation results showed better performance of designed active system in terms of vibration control of sprung mass, suspension travel and tire respectively compared to passive one. Salem and Aly [10] studied the application of Fuzzy and PID control in active quarter car model with 2 degree-of-freedom to enhance the vehicle handling and ride comfort. Simulation results presented the comparative results of Fuzzy and PID controlled suspension systems. Shirjoposht et al. [11] developed an optimal law using states estimation with Extended Kalman Filter (EKF) as well as Taylor series expansion method for an active quarter car model. Simulation results showed the effectiveness of proposed controller compared to proportional integral sliding mode controller in achieving good passenger ride comfort and safety. Gao and Kaynak [12] used Kalman-Yakubovich-Popov (KYP) lemma for improving ride comfort in active quarter car model in specific finite frequency band. Linear matrix inequality optimization was used for feedback controller design. Ismail et al. [13] applied composite nonlinear feedback (CNF) control technique having a linear control law and a nonlinear feedback part for controller design in active suspension system. Simulation results proved the success of CNF controller compared to LQR controller and passive model. Ansari and Taparia [14] used improved sliding mode control with an observer design in active quarter car model to achieve better passenger ride comfort and vehicle handling characteristics. Extensive simulation work showed the better performance of proposed controller in improving the ride comfort and road handling issues. Sun et al. [15] designed a constrained

Dr. Devdutt is Associate Professor in Mechanical Engineering Department, Manav Rachna International University, Faridabad, Haryana, India (e-mail: devdutt.ymca@gmail.com).

Dr. M.L. Aggarwal is Professor in Mechanical Engineering Department, YMCA University of Science and Technology, Faridabad, Haryana, India. (e-mail: aggarwalmlal@rediffmail.com)

adaptive backstepping control scheme to achieve better ride comfort, road holding and minimum suspension movement in active quarter car model. A design example showed the effectiveness of the proposed approach. Emam [16] designed a fuzzy self-tuning mechanism for an active quarter car suspension system to obtain the optimal control gains for PID controller. The simulated graphical results presented the effectiveness of fuzzy self-tuned PID controller compared to PID and passive system in achieving best driver comfort and reduced suspension working space.

Above literature studies in the field of modeling and experimental work of active quarter car system reveal that intelligent controllers play a vital role in achieving improved vibration control response of vehicle structure. However, only a few research investigations have addressed the passenger ride comfort issues in active quarter car suspension system taking passenger seat factor into consideration.

The main concern of present study is to enhance the ride comfort and safety of travelling passengers under various road surfaces using active suspension system. To fulfil this objective, an active quarter car model with three degree of freedom having HFPIDCR in suspension system is considered. Three different control strategies are applied in quarter car model. In first case, main suspension is active type and passenger seat suspension is uncontrolled. In second case, passenger seat suspension is active type while main suspension is uncontrolled. In last case, both main suspension and passenger seat suspension are controlled. The performance of active quarter car systems in controlling passenger seat vibrations is evaluated and compared using numerical simulation under bump and sinusoidal road excitations. Simulation results showed that fully controlled suspension system with HFPIDCR controllers provide best performance for passenger ride comfort taking acceleration and displacement response into account compared to uncontrolled and other controlled suspension systems.

II. ACTIVE QUARTER CAR SYSTEM

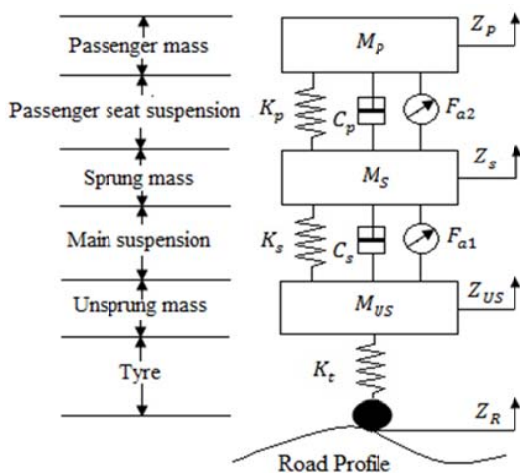

Fig. 1 Active quarter car suspension system

The proposed active quarter car model with three degrees of freedom is shown in Fig. 1. It can rapidly show the performance of suspension system compared to complicated full car model. The model is designed with following parameters, M_p is the passenger seat mass, M_s is the sprung mass and M_{US} is unsprung mass respectively; C_p , C_s , K_s and K_p are damping coefficient and spring stiffness of passenger seat and main suspension respectively; K_t represents tyre stiffness. F_{a1} and F_{a2} are input control force in main suspension and passenger seat suspension; Z_p , Z_s and Z_{US} are displacements of the considered masses while Z_R is the supplied input road excitation to the quarter car model.

The mathematical equations of the fully active quarter car model with three-degrees-of-freedom taking passenger seat dynamics is derived using Newton's 2nd Law of Motion as:

$$M_p \ddot{Z}_p + C_p(\dot{Z}_p - \dot{Z}_s) + K_p(Z_p - Z_s) + F_{a2} = 0 \quad (1)$$

$$M_s \ddot{Z}_s - C_p(\dot{Z}_p - \dot{Z}_s) - K_p(Z_p - Z_s) + C_s(\dot{Z}_s - \dot{Z}_{US}) + K_s(Z_s - Z_{US}) - F_{a2} + F_{a1} = 0 \quad (2)$$

$$M_{US} \ddot{Z}_{US} - C_s(\dot{Z}_s - \dot{Z}_{US}) - K_s(Z_s - Z_{US}) + K_t(Z_{US} - Z_R) - F_{a1} = 0 \quad (3)$$

III. HFPIDCR CONTROLLER DESIGN

A. PID Controller

The conventional Proportional-Integral-Derivative (PID) controller is very effective, popular and mostly used in industries [17]-[19]. A PID controller is also known as a three-term controller and follows the input reference signal. It combines Proportional, Integral and Derivative of the difference in reference signal position and current position of signal supplied from controlled system. The structure of active quarter car model with PID controller is shown in Fig. 2.

The basis of PID control working is given in (4) and (5) as:

$$e(t) = y_{ref} - y \quad (4)$$

$$U_{PID}(t) = K_p e(t) + K_I \sum_{i=0}^t e(t) + K_D \dot{e}(t) \quad (5)$$

where y_{ref} is the reference position and y is the current position while K_p , K_I and K_D are proportional, integral and derivative gains respectively.

B. Fuzzy Controller

The field of fuzzy logic (FL) came into existence in 1965, due to the efforts and vision of Lotfi Zadeh [20]. The first fuzzy logic controller (FLC) was developed by E. H. Mamdani in 1975 for practical application to a steam engine [21]. During the past several years, FL has emerged as one of the most powerful and promising area for research and application in control system field [22]-[24]. It requires expert knowledge and experience about the system under consideration for controlling using fuzzy logic technique. Fuzzy controller works as an artificial decision taker in a closed loop mechatronic based systems in real life. Plant output data is fed

to the controller where it is compared with the reference input signal based on which decision is taken to meet the required or desired performance parameters.

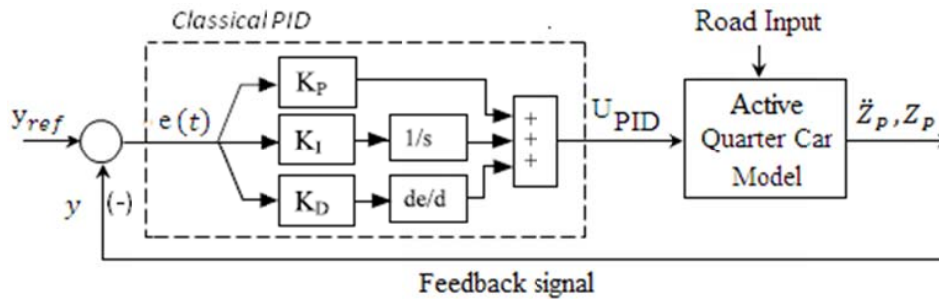

Fig. 2 Conventional PID controller applied in secondary suspension system

In present case, the designed FLC has two different inputs and one output as shown in Fig. 3. The output control force signal (F_a) supplied by fuzzy controller is determined based on the corresponding input levels of error signal, (e) and change of error signal, (de).

The abbreviations used for input and output side linguistic variables are as follows: NB (Negative Big), NM (Negative Medium), NS (Negative Small), ZR (Zero), PS (Positive Small), PM (Positive Medium), and PB (Positive Big) respectively. The input and output membership functions with selected shapes and matching portions as well as with

corresponding surface plot are shown in Fig. 2. The defined intervals for input and output side are in the range of $[-1, 1]$ and $[-3, 3]$ respectively. Actual ranges for variables is decided by multiplication factors S_e , S_{de} and S_u as shown in Fig. 3. The working of fuzzy controller is directed by if-then rules. Here, total 25 if-then rules are written in a matrix form as shown in Table I. In present work, Mamdani method is selected in fuzzy inference system whereas “max-min” inference method is selected as aggregation operator being mostly used and simplest method. For defuzzification stage, “centroid” method is employed.

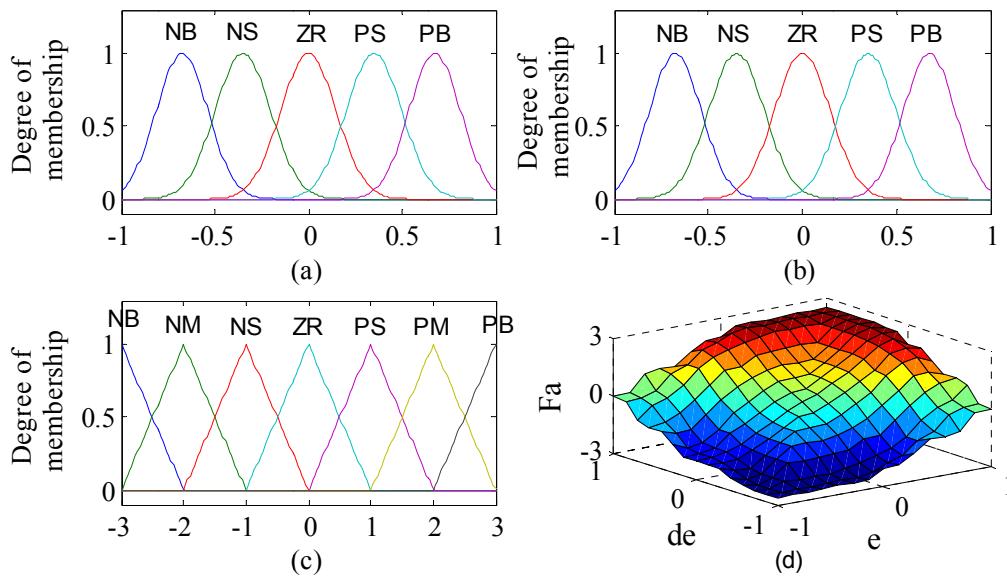

Fig. 3 MFs for FLC (a) Input side, e ; (b) Input side, de ; (c) Output side, F_a ; (d) Surface plot

TABLE I
FLC RULE BASE

de/e	NB	NS	ZR	PS	PB
NB	NB	NB	NB	NM	ZR
NS	NB	NS	NS	ZR	PM
ZR	NB	NS	ZR	PS	PB
PS	NM	ZR	PS	PS	PB
PB	ZR	PM	PB	PB	PB

C. HFPIDCR Controller

PID controller can successfully work for linear systems under stable load conditions. However, its control performance is highly affected and drastically reduced for the systems showing highly nonlinear characteristics during working period. While, FLC is suitable and attractive choice in control applications of complex, highly nonlinear systems

and shows superior response under the varying input conditions.

The proposed HFPIDCR controller can provide the benefits of both fuzzy and PID controllers by further performance improvement in system response in terms of stability and fast control. The continuous response of fuzzy and PID controllers is based on the actuating error signal. HFPIDCR is the advanced stage of HFPID controller in combination with a tuning mechanism for PI and PD actions [25], [26]. The overall structure of HFPIDCR controller with fuzzy controller, PID controller and a switch and tuning mechanism is presented in Fig. 4. The integrated two gain parameters i.e. K_{PI} and K_{PD} can be tuned easily by supplying proper

mathematical values using trial and error method to improve the controller results. The values of selected parameters for working of HFPIDCR controller in the main and passenger seat suspension system are shown in Appendix.

The working of integrated switching mechanism between fuzzy and PID controller as well as resulting output from HFPIDCR controller can be obtained as:

$$Switch = \begin{cases} 1, & \text{if } |e| > w \\ 0, & \text{if } |e| \leq w \end{cases} \begin{matrix} \text{Fuzzy controller} \\ \text{PID controller} \end{matrix} \quad (6)$$

$$U(t) = G_U [K_{PI} \sum_{t=0}^t U_h(t) + K_{PD} U_h(t)] \quad (7)$$

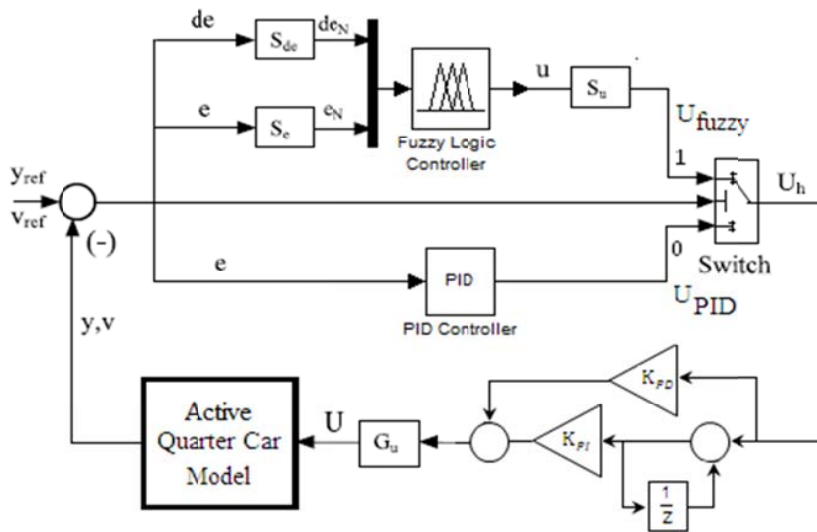

Fig. 4 Structure of HFPIDCR controller

IV. NUMERICAL SIMULATIONS OF 3 DOF SYSTEMS

The simulation work of active quarter car model is performed in MATLAB/Simulink environment to study the performance of HFPIDCR controlled suspension systems. The bump and sinusoidal type road conditions are used to obtain the graphical results in terms of passenger seat acceleration and displacement response at a vehicle speed of 40 km/h. The quarter car parameters selected for simulation purpose are as follows: $M_P = 70$ kg, $M_S = 300$ kg, $M_{US} = 40$ kg, $C_p = 800$ N/m/s, $C_s = 1550$ N/m/s, $K_P = 8000$ N/m, $K_S = 25\ 000$ N/m and $K_t = 180\ 000$ N/m respectively [27].

A. Simulation for Bump Road Profile

The bump road profile with amplitude of 0.05 m for input excitation is shown in Fig. 5. The response of quarter car model in terms of passenger seat acceleration and displacement response is shown in Fig. 6. It can be observed that fully controlled suspension system having HFPIDCR controller in main suspension and passenger seat suspension system provide best improvement in vibration control of passenger seat acceleration and displacement response compared to uncontrolled and other controlled cases. The

computed power spectral density (PSD) of the passenger seat acceleration and displacement response under bump road profile are shown in Fig. 7 for uncontrolled and various controlled suspension systems. It can be observed that maximum reduction in power spectral density of passenger seat acceleration and displacement magnitude is achieved by fully controlled suspension system compared to uncontrolled and other controlled cases.

Table II represents peak and RMS (root mean square) values of passenger seat response for various controlled cases and uncontrolled case on bump road excitation. All three controlled cases provide better results in controlling passenger seat acceleration and displacement responses compared to uncontrolled one. However, it can be seen from Table II that, fully controlled quarter car model is most effective in controlling passenger seat vibrations.

Fig. 8 displays the control force supplied by HFPIDCR controller in suspension system under various control strategies. Table III represents the highest values of control force supplied by HFPIDCR controller in suspension system during rebound and compression stage for bump type of road input.

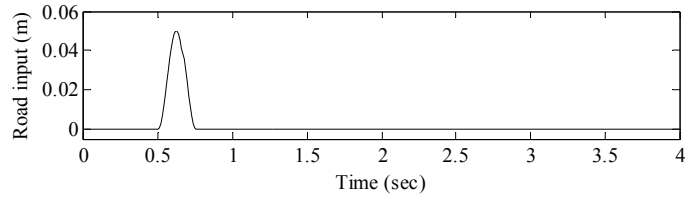

Fig. 5 Bump road profile

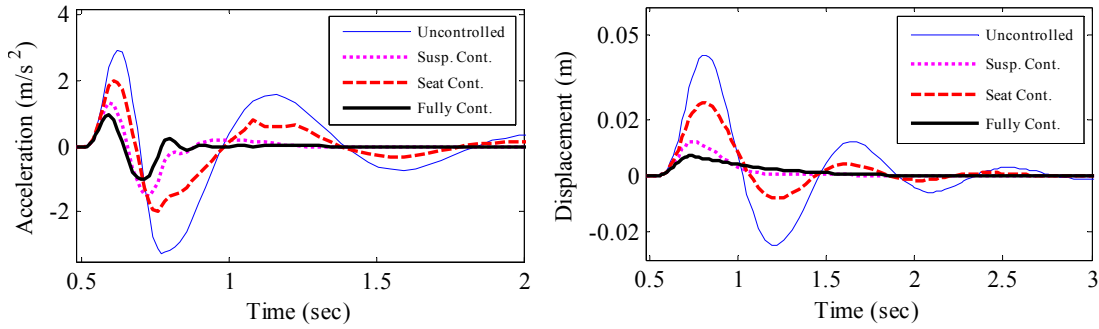

Fig. 6 Bump response of passenger seat acceleration, passenger seat displacement

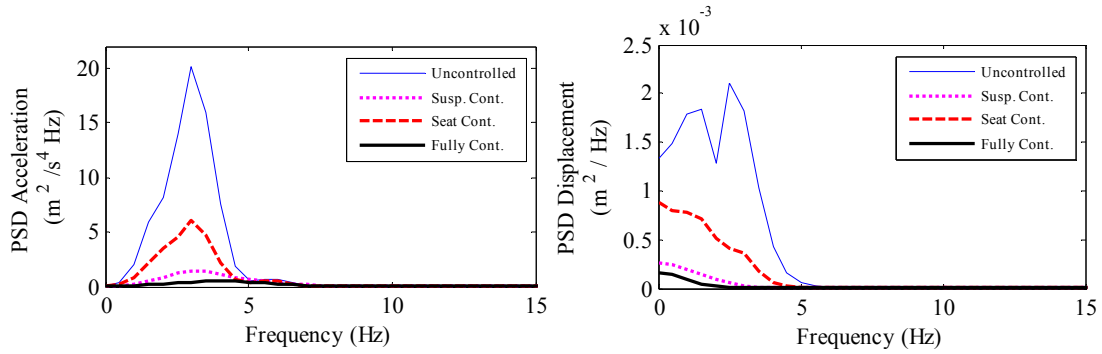

Fig. 7 PSD of passenger seat acceleration, passenger seat displacement

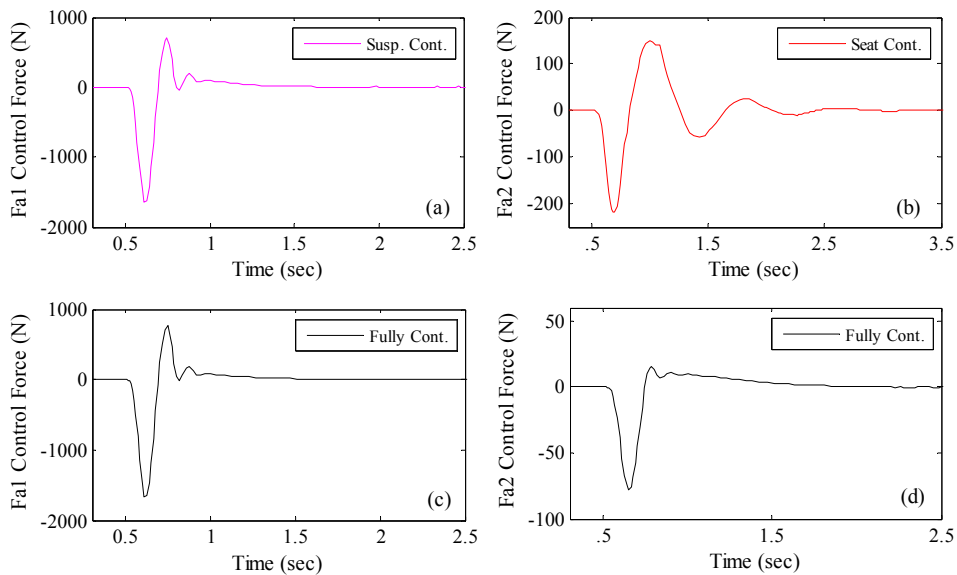

Fig. 8 Control force supplied by HFPIDCR controller in suspension system (a) Suspension controlled; (b) Passenger seat controlled; (c) Fully controlled; (d) Fully controlled

TABLE II
PASSENGER SEAT RESULTS UNDER BUMP ROAD PROFILE

Controller Type	Acceleration (m/s^2)		Displacement (m)	
	Peak	RMS	Peak	RMS
Uncontrolled	2.9570	0.9631	0.0430	0.0123
Seat controlled	1.9962	0.5643	0.0257	0.0071
Suspension controlled	1.3483	0.3414	0.0121	0.0033
Fully controlled	0.9691	0.2283	0.0069	0.0022

TABLE III
CALCULATED MAXIMUM CONTROL FORCE GENERATED BY HFPIDCR CONTROLLER

Working stage	Suspension Controlled	Seat Controlled	Fully Controlled	
	F_{a1} N	F_{a2} N	F_{a1} N	F_{a2} N
Rebound	711.1	150.0	759.7	15.6
Compression	1641.2	218.3	1664.8	77.9

B. Simulation for Sinusoidal Road Profile

In this case, the road irregularities for input excitation to quarter car model are sinusoidal type with amplitude of 0.02 m and frequency of 20 rad/sec as shown in Fig. 9. The passenger seat vibration response in time domain for HFPIDCR controlled and uncontrolled suspension systems can be seen in Fig. 10. It can be seen from Fig. 10 that fully controlled suspension system provide much improved passenger seat acceleration and displacement response under sinusoidal road excitations compared to uncontrolled and other controlled cases.

Fig. 11 shows the computed PSD of the passenger seat acceleration and displacement response under sinusoidal road

profile for uncontrolled and various controlled suspension systems. It can be seen that the fully controlled suspension system provided maximum reduction in PSD of passenger seat acceleration and displacement magnitude showing its effectiveness in achieving best passenger ride comfort compared to uncontrolled and various controlled cases.

Table IV represents peak and RMS values of passenger seat vibrations for acceleration and displacement response for different controlled cases and uncontrolled case on sinusoidal type road excitation. The passenger seat vibration reduction response is best in case of fully controlled suspension system in quarter car model compared to all other cases.

TABLE IV
PASSENGER SEAT RESULTS UNDER SINUSOIDAL ROAD PROFILE

Controller Type	Acceleration (m/s^2)		Displacement (m)	
	Peak	RMS	Peak	RMS
Uncontrolled	2.1665	1.3792	0.0127	0.0041
Seat controlled	1.1899	0.8603	0.0076	0.0024
Suspension controlled	0.7243	0.5292	0.0040	0.0014
Fully controlled	0.5654	0.3240	0.0023	0.0009

Fig. 12 shows the supplied control force by HFPIDCR controller in quarter car suspension system by various used control strategies. Table V displays the peak values of generated control force by HFPIDCR controller in suspension system during rebound and compression stage for sinusoidal type of road excitation.

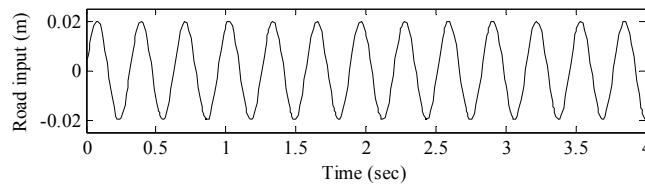

Fig. 9 Sinusoidal road profile

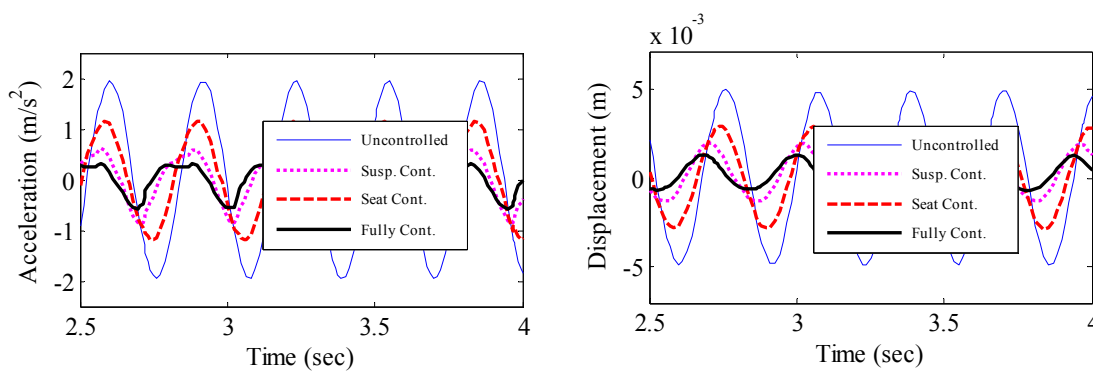

Fig. 10 Sinusoidal response of passenger seat acceleration, passenger seat displacement

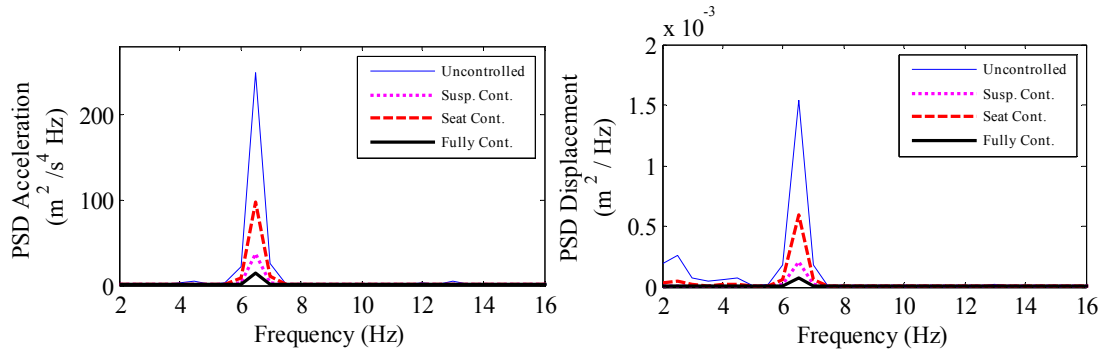

Fig. 11 PSD of passenger seat acceleration, passenger seat displacement

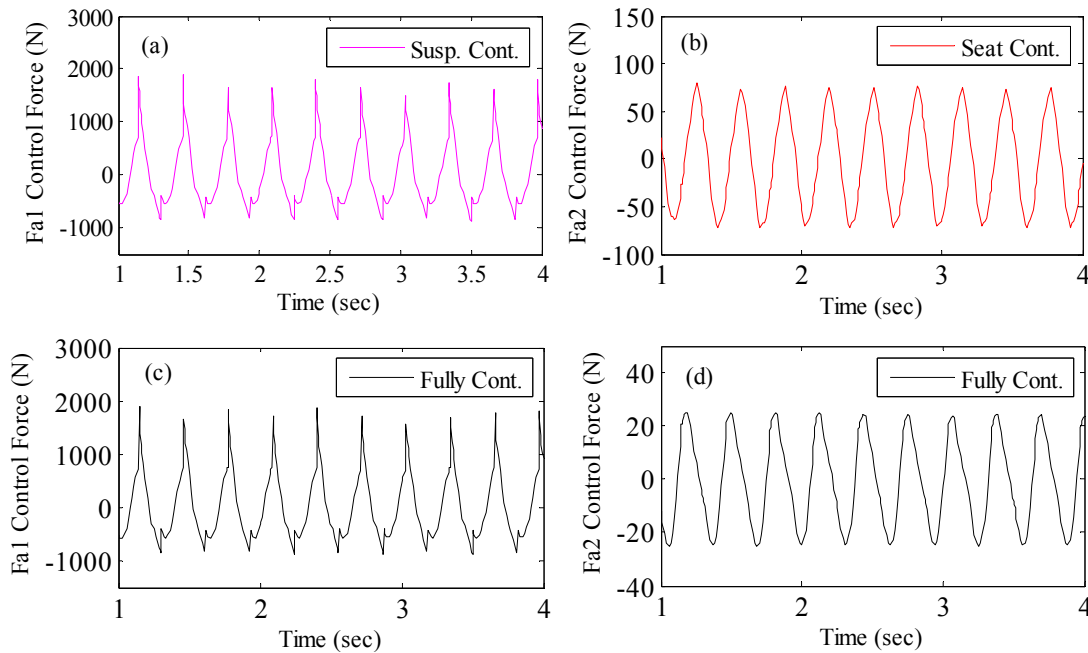

Fig. 12 Control force supplied by HFPIDCR controller in suspension system (a) Suspension controlled; (b) Passenger seat controlled; (c) Fully controlled; (d) Fully controlled

TABLE V
CALCULATED MAXIMUM CONTROL FORCE GENERATED BY HFPIDCR CONTROLLER

Working stage	Suspension Controlled	Seat Controlled	Fully Controlled	
	F_{a1} N	F_{a2} N	F_{a1} N	F_{a2} N
Rebound	1877.5	96.7	1891.8	29.8
Compression	862.3	85.9	875.6	33.6

V. CONCLUSIONS

In this paper, vibration control of passenger seat in quarter car model with three degrees of freedom was studied. Three different controlled cases with HFPIDCR controller were considered. In first case, controller was used in main suspension; in second case, controller was used in passenger seat suspension while in third case, controller was used in main and passenger seat suspension of active quarter car model. Simulation work was done under bump and sinusoidal

type road excitations. Simulation results in graphical and mathematical terms showed the best effectiveness of fully controlled suspension system in vibration control of passenger seat compared to other used strategies.

APPENDIX

TABLE VI
CONTROLLER PARAMETERS FOR MAIN SUSPENSION SYSTEM

PID Gains		FLC input – output scaling factors
$K_P = 1500$	$K_{PI} = 0.01$	$S_e = 2$
$K_I = 100$	$K_{PD} = 1.4$	$S_{de} = 1$
$K_D = 1000$	$G_u = 8$	$S_u = 1500$

TABLE VII
CONTROLLER PARAMETERS FOR PASSENGER SEAT SUSPENSION SYSTEM

PID Gains		FLC input – output scaling factors
$K_P = 300$	$K_{PI} = 0.01$	$S_e = 2$
$K_I = 50$	$K_{PD} = 1.4$	$S_{de} = 1$
$K_D = 600$	$G_u = 1.4$	$S_u = 400$

REFERENCES

- [1] Savaresi, S.M. & Spelta, C. (2009). A single-sensor control strategy for semi-active suspensions. *IEEE Trans. Control Syst. Technol.*, 17, 143–52.
- [2] Hong, F. & Pang, C.K. (2012). Robust vibration control at critical resonant modes using indirect-driven self-sensing actuation. *Mechatronic Systems. ISA Trans.*, 51, 834–40.
- [3] Aghababa, M.P. (2013). A fractional-order controller for vibration suppression of uncertain structures. *ISA Trans.*, 52, 881–7.
- [4] Sie, W.T., Lian, R.J. & Lin, B.F. (2006). Enhancing grey prediction fuzzy controller for active suspension systems. *Veh. Syst. Dyn.*, 44(5), 407–430.
- [5] Fialho, I. & Balas, G. J. (2002). Road adaptive active suspension design using linear parameter-varying gain-scheduling. *IEEE Trans. Contr. Syst. Technology*, 10(1), 43–54.
- [6] Huang, S.J., Lin & W.C. (2003). A neural network sliding controller for active vehicle suspension. *Materials Science Forum*, 440-441, 119-126.
- [7] Lauwerys, C., Swevers, J. & Sas, P. (2005). Robust linear control of an active suspension on a quarter car test-rig. *Control Engineering Practice*, 13(5), 577-586.
- [8] Huang, S.J. & Chen, H.Y. (2006). Adaptive sliding controller with self-tuning fuzzy compensation for vehicle suspension control. *Mechatronics*, 16, 607–22.
- [9] Mouleeswaran, S. (2008). Development of active suspension system for automobiles using PID controller. *Proceedings of the World Congress on Engineering Vol. II WCE 2008, July 2 -4, 2008, London, U.K.*
- [10] Salem, M.M.M. & Aly, A.A. (2009). Fuzzy control of a quarter-car suspension system. *World Academy of Science, Engineering and Technology*, 3 (5), 224-229.
- [11] Shirjoposht, N.P., Hassanzadeh, I., Hashemzadeh, F. & Alizadeh, G. (2010). Optimal active suspension control based on a quarter-car model: an analytical solution. *International Journal of Vehicle Safety (IJVS)*, 5(1), 1-20.
- [12] Sun, W., Gao, H. & Kaynak, O. (2011). Finite frequency H_∞ control for vehicle active suspension systems. *IEEE Trans. Control Syst. Technol.*, 19, 416–22.
- [13] Ismail, M. F., Peng, K., Hamzah, N., Sam, Y.M., Aripin, M.K. & Hasan, M.H.C. (2012). A linear model of quarter car active suspension system using composite nonlinear feedback control. *Proceeding of the IEEE Student Conference on Research and Development (SCORED '12), Pinang, Malaysia, December 98–103*
- [14] Ansari, F.A. & Taparia, R.S. (2013). Modeling, analysis and control of active suspension system using sliding mode control and disturbance observer. *International Journal of Scientific and Research Publications*, 3(1), 1-6.
- [15] Sun, W., Pan, H., Zhang, Y. & Gao, H. (2014). Multi-objective control for uncertain nonlinear active suspension systems. *Mechatronics*, 24(4), 318–327.
- [16] Emam, A.S. (2015). Fuzzy Self Tuning of PID controller for active suspension system. *Advances in Powertrains and Automotives*, 1(1), 34-41.
- [17] Shabani, H., Vahidi, B. & Ebrahimpour, M. (2013). A robust PID controller based on imperialist competitive algorithm for load–frequency control of power systems. *ISA Transactions*, 52, 88–95.
- [18] Aboelela, M.A.S., Ahmed, M.F. & Dorrah, H.T. (2012). Design of aerospace control systems using fractional PID controller. *Journal of Advanced Research*, 3(3), 225–232.
- [19] Vanavil, B., Chaitanya, K. K. & Rao, A.S. (2015). Improved PID controller design for unstable time delay processes based on direct synthesis method and maximum sensitivity. *International Journal of Systems Science*, 46(8), 1349–1366.
- [20] Zadeh, L. (1965). Fuzzy sets. *Information and Control*, 8(5), 338–353.
- [21] Mamdani, E. & Assilian, S. (1975). An experiment in linguistic synthesis with a fuzzy logic controller. *International Journal of Man-Machine Studies*, 7(1), 1-13.
- [22] Topalov, A. V., Yesim, O., Kayacan, E. & Kaynak, O. (2011). Neuro-fuzzy control of antilock braking system using sliding mode incremental learning algorithm. *Neurocomputing*, 74(11), 2011, 1883-1893.
- [23] Boada, B. L., Boada, M. J. L. & Diaz, V. (2005). Fuzzy-logic applied to yaw moment control for vehicle stability. *Vehicle System Dynamics*, 43(10), 753-770.
- [24] Lin, Y. J., Lu, Y. Q. & Padovan, J. (1993). Fuzzy logic control of vehicle suspension systems. *International Journal of Vehicle Design*, 14(5), 457-470.
- [25] Cetin, S. & Akkaya, A.V. (2010). Simulation and hybrid fuzzy-PID control for positioning of a hydraulic system. *Nonlinear Dynamics*, 61(3), 465–476.
- [26] Demir, O., Keskin, I., Cetin, S. (2012). Modeling and control of a nonlinear half-vehicle suspension system: a hybrid fuzzy logic approach. *Nonlinear Dynamics*, 67(3), 2139–2151.
- [27] Devdutt & Aggarwal, M.L. (2014) Fuzzy control of passenger ride performance using MR shock absorber suspension in quarter car model. *International Journal of Dynamics and Control* DOI 10.1007/s40435-014-0128-z.