

Analysis of Effects of Magnetic Slot Wedges on Characteristics of Permanent Magnet Synchronous Machine

B. Ladghem Chikouche

Abstract—The influence of slot wedges permeability on the electromagnetic performance of three-phase permanent magnet synchronous machine is investigated in this paper. It is shown that the back-EMF waveform, electromagnetic torque and electromagnetic torque ripple are all significantly affected by slot wedges permeability. The paper presents an accurate analytical subdomain model and confirmed by finite-element analyses.

Keywords—Exact analytical calculation, finite-element method, magnetic field distribution, permanent magnet machines performance, stator slot wedges permeability.

I. INTRODUCTION

IN large electrical machines the stator slots are opened to the width of the slot to allow for coils fitting. The reason for that is to ease the assembling process of the stator winding coils. However, these wide opened stator slots lead to higher harmonic components in the air-gap field, increasing pulsations between stator and rotor, uneven distributed flux density, higher noise and vibration. The overall losses are increased and the performance of the machine is altered [1]. To counteract this fact, in some cases magnetic stator slot wedges are placed into stator notches, the purpose of the slot wedges is not only to help the winding withstand electrodynamic forces, particularly during start up [2], [3], but also to filter out undesirable harmonics or induced undesirable effects from the magnetic field distribution in the air-gap [4]-[6]. To weaken the pulsations of the harmonic magnetic field and improve the waveform of the air-gap magnetic field, magnetic slot wedge should be imbedded into the slot opening. The choice of magnetic wedges is a complicated problem since the addition of a magnetic material reduces the elasticity and long term mechanical breakdown capability of the wedge [7].

For a long time, the beneficial effect of ferrite magnetic wedges, in terms of reduction of air-gap flux density pulsations, has been known to designers of classical induction and synchronous machines.

In the paper, the influence of the slot wedges, including non-magnetic and magnetic ones, on the air-gap magnetic field distribution and the performance of the machines is investigated and analyzed theoretically. An accurate analytical subdomain model for the open-circuit magnetic field in

PMSM is presented. The calculations were performed using the linear B-H curve of the machine core. The non-linear model is also studied for comparison. The finite element model of the machine was used to validate the results.

II. ANALYTICAL FIELD MODEL

Some assumptions are made in the paper to simplify the problem as follows:

- 1) The ideal slot shapes are as shown in Fig. 1;
- 2) Permeability of stator/rotor iron is infinite;
- 3) End effects are negligible;
- 4) Magnet material is nonconductive;
- 5) Magnetization is radial; and
- 6) Demagnetization characteristics of magnet are linear.

As can be seen in Fig. 1, the whole domain of the field problem can be divided into four types of subdomains, magnet (Region I), air-gap (Region II), stator slot-opening (Region III) and stator slot (Region IV).

The general expressions of the scalar potential distributions in polar coordinates can be expressed by:

a) Region I:

$$\frac{\partial^2 A^I(r, \theta)}{\partial r^2} + \frac{1}{r} \frac{\partial A^I(r, \theta)}{\partial r} + \frac{1}{r^2} \frac{\partial^2 A^I(r, \theta)}{\partial \theta^2} = -\frac{\mu_0}{r} \left(M_\theta(\theta) - \frac{\partial M_r(\theta)}{\partial \theta} \right) \quad (1)$$

b)Region II and III:

$$\frac{\partial^2 A^{II,III}(r, \theta)}{\partial r^2} + \frac{1}{r} \frac{\partial A^{II,III}(r, \theta)}{\partial r} + \frac{1}{r^2} \frac{\partial^2 A^{II,III}(r, \theta)}{\partial \theta^2} = 0 \quad (2)$$

c)Region IV:

$$\frac{\partial^2 A^{IV}(r, \theta)}{\partial r^2} + \frac{1}{r} \frac{\partial A^{IV}(r, \theta)}{\partial r} + \frac{1}{r^2} \frac{\partial^2 A^{IV}(r, \theta)}{\partial \theta^2} = \frac{1}{r^2} \frac{\partial^2 A^{IV}(r, \theta)}{\partial \theta^2} = -\mu_0 J \quad (3)$$

where $M(\theta, \alpha) = [M_r(\theta, \alpha), M_\theta(\theta, \alpha)]$, μ_0, J, α are respectively the magnetization of permanent magnet, the permeability of vacuum, the stator slots current density and the relative angular position between the PM and the original axis.

B. Ladghem Chikouche is with the Department of Electrical Engineering, University of Mohamed Boudiaf, Msila, Algeria (e-mail: lehbrahim@gmail.com).

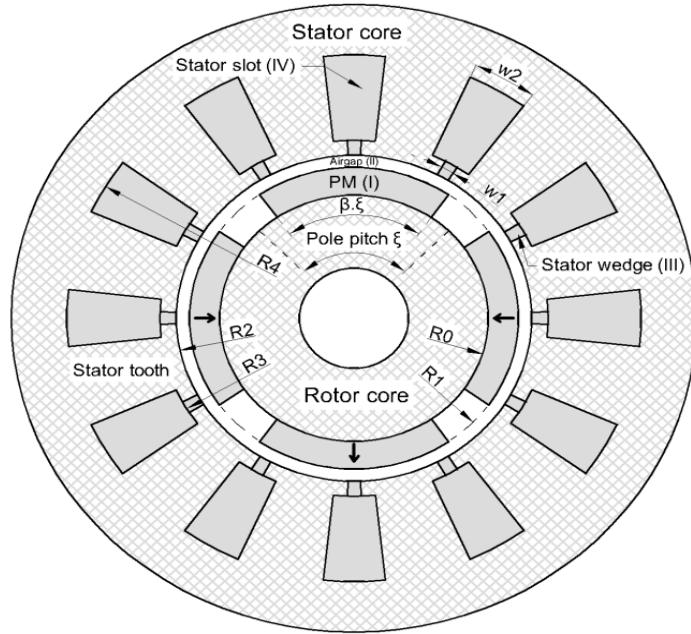

Fig. 1 Studied PM machine

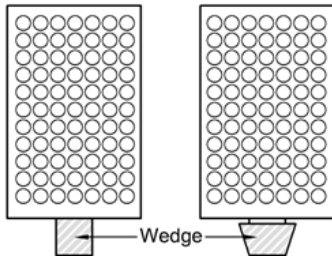

Fig. 2 Simple and real slot wedges

A. Analytical Resolution of the Laplace and Poisson's Equation for the Different Regions

a)Region I:

$$A^I(r, \theta) = \sum_{n=1}^{nh} \left(C_{3n}^I r^{np} + C_{4n}^I r^{-np} + \psi_s(r) \right) \sin(np.\theta) + \sum_{n=1}^{nh} \left(C_{5n}^I r^{np} + C_{6n}^I r^{-np} + \psi_c(r) \right) \cos(np.\theta) \quad (4)$$

b)Region II:

$$A^{II}(r, \theta) = \sum_{n=1}^{nh} \left(C_{3n}^{II} r^{np} + C_{4n}^{II} r^{-np} \right) \sin(np.\theta) + \sum_{n=1}^{nh} \left(C_{5n}^{II} r^{np} + C_{6n}^{II} r^{-np} \right) \cos(np.\theta) \quad (5)$$

c)Region III:

$$A_i^{III}(r, \theta) = C_{i1}^{III} \ln(r) + C_{i2}^{III} + \sum_{k=1}^{nh} \left(C_{i3k}^{III} r^{\frac{k\pi}{w1}} + C_{i4k}^{III} r^{-\frac{k\pi}{w1}} \right) \cdot \cos\left(\frac{k\pi}{w1} \left(\theta - g_i + \frac{w1}{2} \right)\right) \quad (6)$$

d)Region IV:

$$A_i^{IV}(r, \theta) = C_{i1}^{IV} \ln(r) + C_{i2}^{IV} + G_{i1}(r) + \sum_{m=1}^{nh} \left(C_{i3k}^{IV} r^{\frac{m\pi}{w2}} + C_{i4k}^{IV} r^{-\frac{m\pi}{w2}} + G_{i2}(r) \right) \times \cos\left(\frac{m\pi}{w2} \left(\theta - g_i + \frac{w2}{2} \right)\right) \quad (7)$$

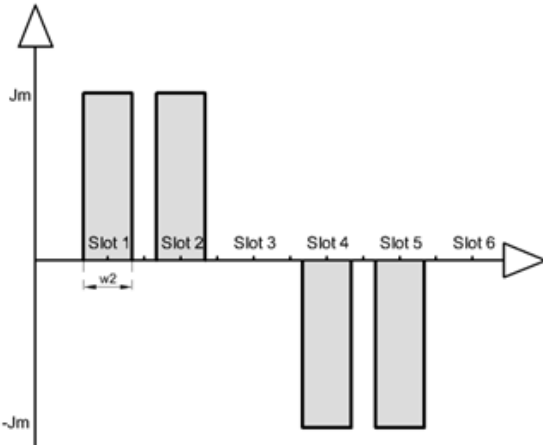

Fig. 3 Distribution of stator slots current density

The distribution of stator slots current density in the different stator slots depends on the type of winding. The density of current is shown on Fig. 3.

where subscript (*i*) denotes (*ith*) slot. $G_{i1}(r)$, $G_{i2}(r)$ are the particular solutions of Poisson Equation (4) and $C^{I,II,III,IV}$ are the constants to be determined by the boundary conditions. The interface conditions must satisfy the continuity of the radial component of the flux density and the continuity of the tangential component of the magnetic field. Radial and circumferential flux density components are deduced from A by:

$$B_r(r, \theta) = \frac{1}{r} \frac{\partial A(r, \theta)}{\partial r} \quad (8)$$

$$B_\theta(r, \theta) = -\frac{\partial A(r, \theta)}{\partial \theta} \quad (9)$$

B. Flux Linkage, Back-Emf and Electromagnetic Torque Calculation

The back-EMF is the important factor affecting the characteristics of electric machine and is given by the rate of change of the flux linkage according to time variations. Before back EMF is calculated, the flux linkage can be obtained as:

$$\phi_i^{IV}(\alpha) = \frac{N_s L}{S} \int_{\theta_i - w/2}^{\theta_i + w/2} \int_{R_3}^{R_4} A_i^{IV}(r, \theta, \alpha) r dr d\theta \quad (10)$$

where N_s, L are respectively the cross section area of the stator slots and the series turns per phase. The total flux linkage due to PMs can be expressed as:

$$\psi_{ph}^{IV}(\alpha) = C_m \phi_i^{IV}(\alpha) \quad (11)$$

where C_m is the connecting matrix which represents the distribution of stator windings within the slots. As a consequence, the phase back-EMF can be calculated by:

$$E_{ph} = \Omega_r \frac{d\psi_{ph}^{IV}(\alpha)}{d\alpha} \quad (12)$$

The electromagnetic torque (T_{em}) can be calculated by integrating Maxwell's stress tensor along a circle with constant radius (r) located inside the air-gap or by:

$$T_{em} = \frac{E_A I_A + E_B I_B + E_C I_C}{\Omega_r} \quad (13)$$

According to the results presented in Fig. 4, the effect of the presence of the slots on the flux density starts to vanish as soon as the relative permeability of the slot wedges increases. The question which arises now is whether it is possible to use a slot wedge of the ferromagnetic type or not.

So far, the calculation is carried on the basis of the assumption of the linearity of the magnetic circuit. However, there are regions where this assumption is not practically applicable particularly within the small regions like the teeth in which case it is necessary to compare the analytical results (linear) with those derived by the FEA (non-linear). The study is limited to the tangential flux density.

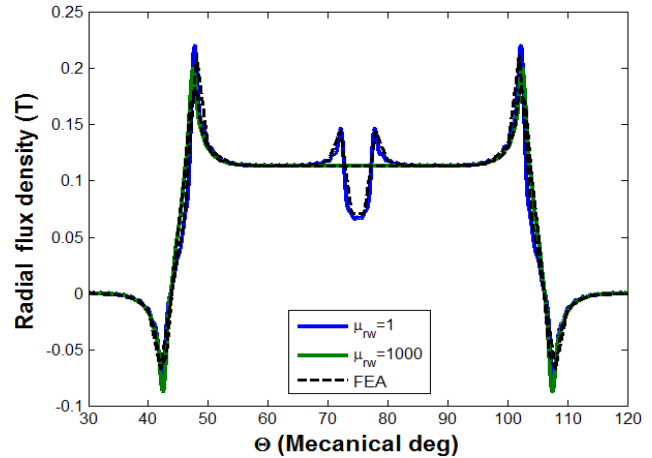

Fig. 4 Radial component of the flux density due to the sole stator current

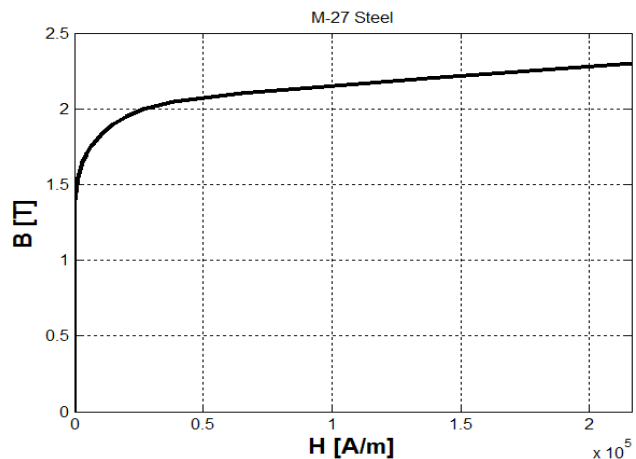
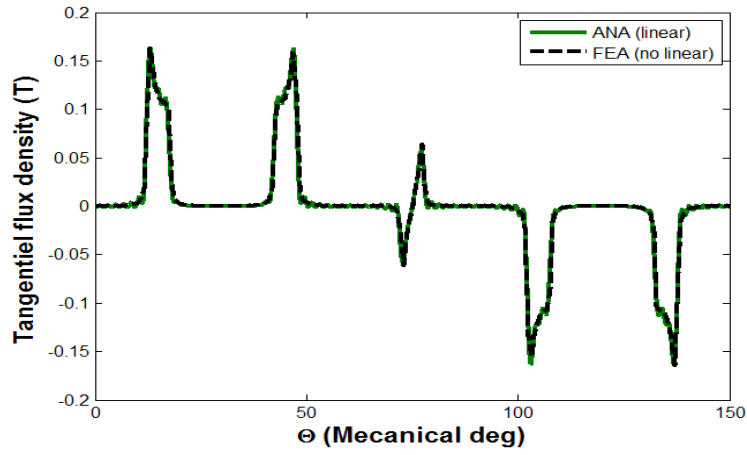

Fig. 5 $B = f(H)$

The type of the magnetic circuit material is M-27; its magnetic characteristics are shown in Fig. 5.

The permeability of the slot wedge is selected to be around 5, so that the lines of magnetic field can cross the slots and also avoid the saturable portions of the circuit; as shown in Fig. 7.

According to Fig. 6, the difference is clearly revealed for μ_{rw} and that is because of the saturation of the teeth.



(a)

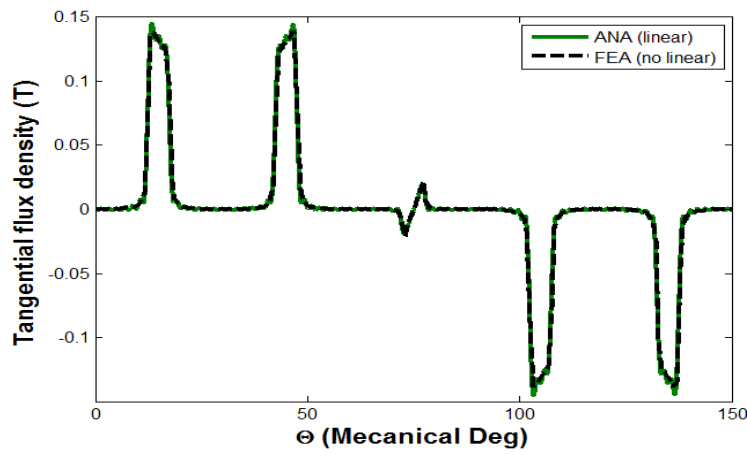

(b)

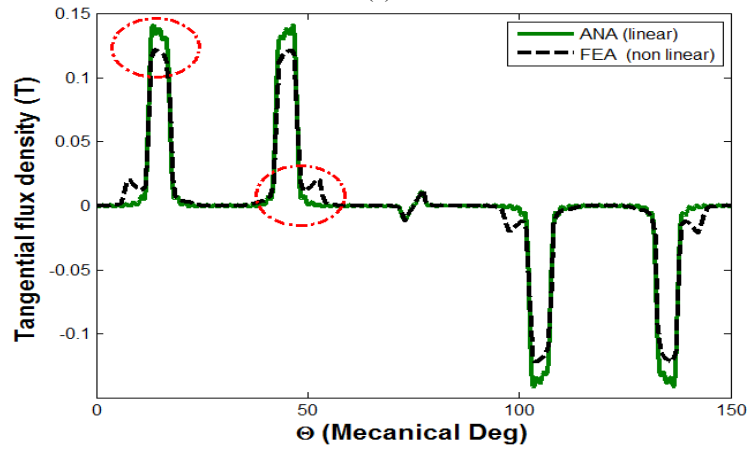

(c)

Fig. 6 Tangential component of the flux density due to the sole stator current for (a) $\mu_{rw} = 1$, (b) $\mu_{rw} = 5$ and (c) $\mu_{rw} = 10$

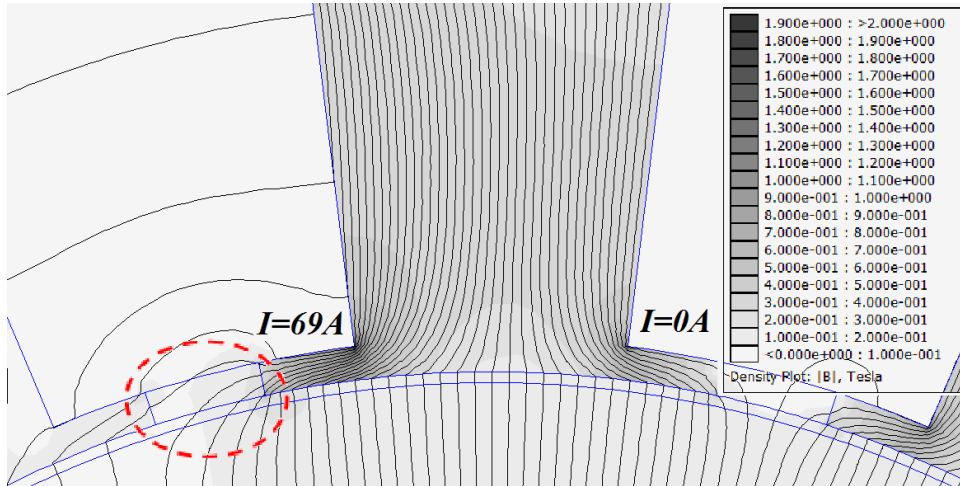

(a)

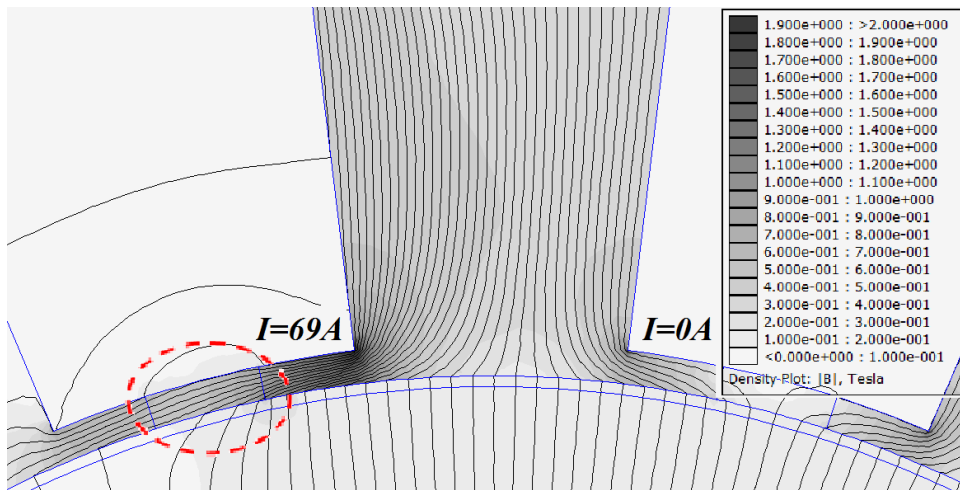

(b)

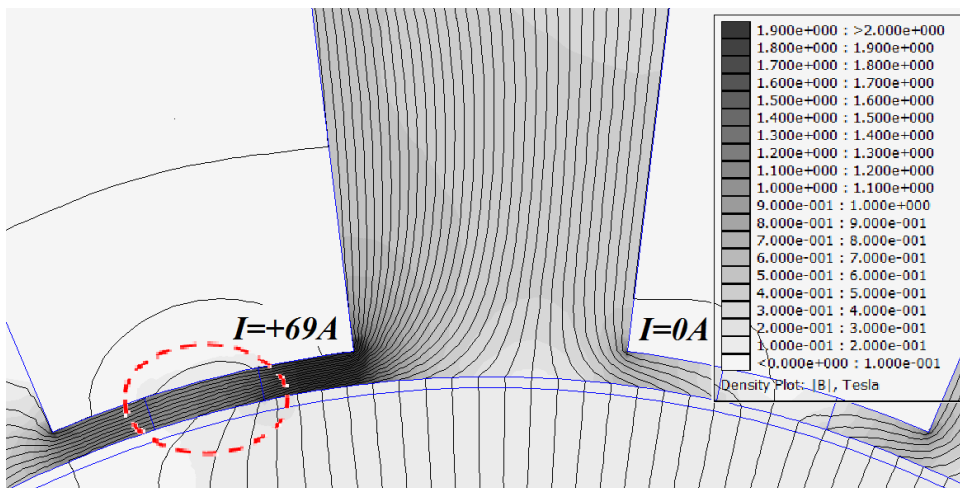

(c)

Fig. 7 Lines of magnetic field distribution due to the sole stator current for different values of μ_{rw} (a) $\mu_{rw} = 1$ (b) $\mu_{rw} = 5$ and (c) $\mu_{rw} = 10$

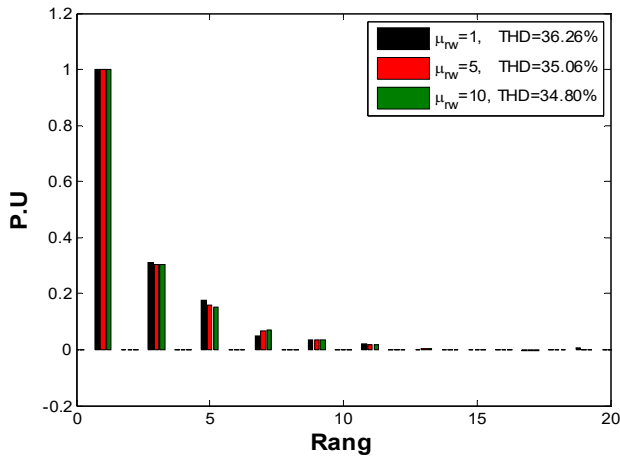
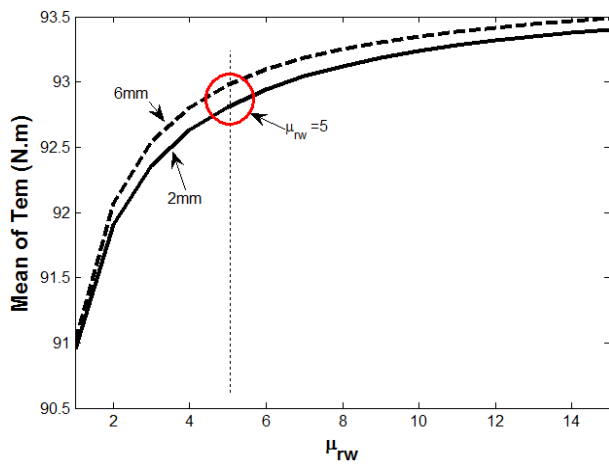
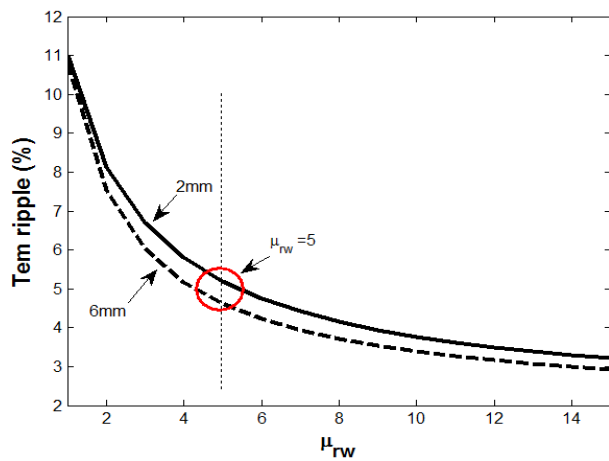

Fig. 8 Harmonic spectrum analysis for back-EMF for different values of slot wedges permeability



(a)



(b)

Fig. 9 Electromagnetic torque mean value and ripple representation for different values of μ_{rw} and depth of stator wedge $\beta = 93\%$

TABLE I
PARAMETERS OF THE EXPERIMENTAL MACHINE

Parameter	Symbole	Value and unite
Magnet remanence	B_{rm}	1.28 T
Magnet relative permeability	μ_r	1
Pole-pairs number	p	2
Magnetization direction	-	Radial
Number of slots	Q_s	12
Stator wedge-opening span angle	w_1	6°
Stator slot-opening span angle	w_2	20°
Wedge relative permeability	μ_{rw}	Variable
Number of conductors per rotor slot	N_c	10
Outer rotor radius	R_0	57.50 mm
Outer magnet radius	R_1	64.00 mm
Stator bore radius	R_2	64.65 mm
Outer slot-opening radius	R_3	66.65 mm
Outer stator slot radius	R_4	92.70 mm
Stack length	L	150.0 mm
Harmonics number	N_h	99

In order to study the harmonic content of the back-EMF, the FFT is used. FFT computation is implemented using MATLAB software. The harmonic content related to back-EMF for different values of slot wedges permeability is shown in Fig. 8. The 3rd, 5th and 7th harmonics give some information about the influence of slot wedges permeability on the back-EMF waveform, in spite of a small difference observed between the amplitudes of the harmonics of these orders. The effect of a variable wedge height has been studied. Two advantages are seen in Figs. 9 (a) and (b) for the electromagnetic torque if the relative permeability of the slot wedges increases. The first one is the increase of the mean value of the electromagnetic torque and that is justified by the filtering of the radial flux density due to the magnets, the effect of the slot being not significant. The second one is the reduction of the electromagnetic torque ripple, because the shape of the EMF has been improved, its shape being now close to the sine waveform. Furthermore, the subsequent reduction in reluctance introduced by using magnetic wedges has a double effect on the PM flux: on one hand, it helps convey additional flux into the stator teeth, thus improving the flux linkage and, on the other one, it provides a lower reluctance path for PM leakage flux, thus causing a possible reduction in the stator flux linkage. The predominance of one effect relatively to the other depends on the geometry of the machine.

III. CONCLUSION

In this paper, an accurate analytical method based on subdomain method is presented to determine the performances of permanent magnet synchronous machine according to magnetic slot wedges effect. As a result, the flux density distribution in the air-gap and the electromagnetic torque are studied in this paper. The introduction of the slot wedges made the machine become more effective and the

motor performance is greatly improved, as far as minimization of the effect of teeth-related harmonics is concerned. Evidence of the corresponding influence is especially shown based on the improvement of the ripple of the electromagnetic torque.

REFERENCES

- [1] H. Mikami, K. Ide, K. Arai, M. Takahashi, and K. Kajiwara, "Dynamic harmonic field analysis of a cage type induction motor when magnetic slot wedges are applied," *IEEE Trans. Energy Convers.*, Vol. 12, no. 4, pp. 337-343, Apr. 1997.
- [2] R.A. Hanna, W. Hiscock, and P. Klinowski, "Failure analysis of three slow-speed induction motors for reciprocating load application," *IEEE Trans. on Ind. Appl.*, Vol. 43, no. 2, pp. 429-435, Mar./Apr. 2007.
- [3] R. Li, H. Li, "Improvements in energy efficiency of induction motors by the use of magnetic wedges," *Petroleum and Chemical Industry Conference (PCIC)*, 2011 Record of Conference Papers Industry Applications Society 58th Annual IEEE, vol., no., pp. I-6, 19-21 Sept 2011.
- [4] A. Tessarolo, A. F. Luise, M. Bortolozzi, M. Mezzarobba, "New Magnetic Wedge Design for Enhancing the Performance of Open-Slot Electric Machines," *IEEE Conference Publications in Electrical Systems for Aircraft, Railway and Ship Propulsion (ESARS)*, 2012
- [5] S. Wang, Z. Zhao, L. Yuan, B. Wang, "Investigation and Analysis of the Influence of Magnetic Wedges on High Voltage Motors Performance," *IEEE Vehicle Power and Propulsion Conference (VPPC)*, September 3-5, 2008, Harbin, China.
- [6] G. D. Donato, F. G. Capponi and F. Caricchi, "On the Use of Magnetic Wedges in Axial Flux Permanent Magnet Machines," *IEEE Trans. on Ind. Elect.*, Vol. 60, no. 11, November 2013.
- [7] M. Dems, K. Komęza, J. K. Sykulski, "Analysis of effects of magnetic slot wedges on characteristics of large induction motor," *In Proceedings of the 15th International Symposium on Electromagnetic Fields in Mechatronics, Electrical and Electronic Engineering (ISEF '11)*, Funchal, Portugal, September 2011.