

Providing Energy Management of a Fuel Cell-Battery Hybrid Electric Vehicle

Fatma Keskin Arabul, Ibrahim Senol, Ahmet Yigit Arabul, Ali Rifat Boynuegri

Abstract—On account of the concern of the fossil fuel is depleting and its negative effects on the environment, interest in alternative energy sources is increasing day by day. However, considering the importance of transportation in human life, instead of oil and its derivatives fueled vehicles with internal combustion engines, electric vehicles which are sensitive to the environment and working with electrical energy has begun to develop. In this study, simulation was carried out for providing energy management and recovering regenerative braking in fuel cell-battery hybrid electric vehicle. The main power supply of the vehicle is fuel cell on the other hand not only instantaneous power is supplied by the battery but also the energy generated due to regenerative braking is stored in the battery. Obtained results of the simulation is analyzed and discussed.

Keywords—Electric vehicles, fuel cell, battery, regenerative braking, energy management.

I. INTRODUCTION

DUE to the increasing world's population day by day and technological progress, energy requirements are increasing. Because of that alternative energy sources became an interesting research area due to depletion of fossil fuels, environmental concerns and needs.

Electric vehicles (EVs) that have high efficiency and low emissions, are preferred to internal combustion engines (ICE) vehicles that working with oil and its derivatives to avoid the negative effects of CO₂ emissions [1]. Besides, the low efficiency of ICEs especially at lower rpms has made EVs more attractive. Researchers concentrate on several topics about EVs however, researches about efficiency and range is more popular than other topics. Recovering regenerative braking energy, energy management strategy with load sharing and comparison of different hybrid topologies are the topics that have become prominent in EV applications [2], [3].

Fuel cells (FC) are used as the main energy source for EVs according to developments in FC technologies. Thus, vehicles are quite, with high efficiency and work more smoothly than ICE vehicles. But one of the disadvantage of FC systems is they cannot store the regenerative braking energy. In order to increase range and lower hydrogen consumption, the studies are performed to recover braking energy and manage the energy between energy storage devices [3].

This study is carried out an energy management strategy which adapted to Proton Exchange Membrane Fuel Cell and Lithium-ion Battery (PEMFC/BAT) hybrid EV system. In this system, FC is used to supply main load demand of the system

and the battery is used to gain braking energy and supply instant load changes.

Instant power demands have a significant effect on FC's lifetime [4]. FCs have some disadvantages like excessive hydration and dry membrane when instant installation [5]. In addition, instant and large changes in power decrease also in lifetime of batteries and cause overheating due to internal resistance of the battery [6]. To avoid from these negative effects, power sharing is carried out in accordance with the battery and FC's natural features.

Urban Dynamometer Driving Schedule (UDDS) drive cycle has been established on the basis of a load model. A boost DC-DC converter is used at the output of FC to supply generated load demand. The load is supplied how FC's output voltage is raised at a certain value with the boost DC-DC converter. A bidirectional DC-DC converter is used in the output of the lithium-ion battery and this converter is operated buck or boost mode according to the direction of the energy flow.

Bidirectional converter is designed to transfer the braking energy to battery. Bidirectional DC-DC converter brings additional costs however it improves performance and efficiency.

In this paper simulation studies about energy management between FC and battery are explained in Section II, the results are given in Section III, conclusion and suggestions are presented in Section IV.

II. SIMULATION STUDIES

In order to test the conditions that an electrical vehicle will be exposed in an urban drive cycle, a simulation study that shown in Fig. 1 is designed in MATLAB/Simulink platform.

As shown in Fig. 1, a boost DC-DC converter is used at the output of FC to increase the FC voltage. A bidirectional DC-DC converter is used at the output of the battery and operated buck (backward) or boost (forward) mode according to DC bus voltage.

To this end, UDDS that's power demand-time graph shown in Fig. 2, is used for testing a lightweight EV [7]. In this system, a 50 kW PEM FC and a 500 V 10 Ah lithium-ion battery are used to supply energy demand of electrical vehicle. Instant load changes of an EV cause's permanent damages to the FCs unless over sizing the FC parameters. Also obtaining all the power from FC in an EV causes an increase in size and cost of the system. In addition the recovery of braking energy is not possible with the existing FCs [2]. Therefore, the FC is supported by a lithium-ion battery.

Boost converter is used in the output of the FC to increase

Fatma Keskin Arabul is with the Yildiz Technical University, İstanbul, Turkey (e-mail: fkeskin@yildiz.edu.tr).

625 V to 900V. Bidirectional converter in the output of the battery is used both to supply the load in instant loading conditions and also to recover regenerative braking energy.

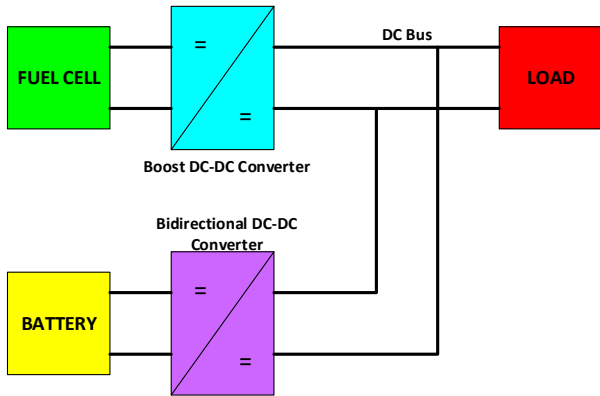

Fig. 1 The block shape of the PEM FC/ battery hybrid system

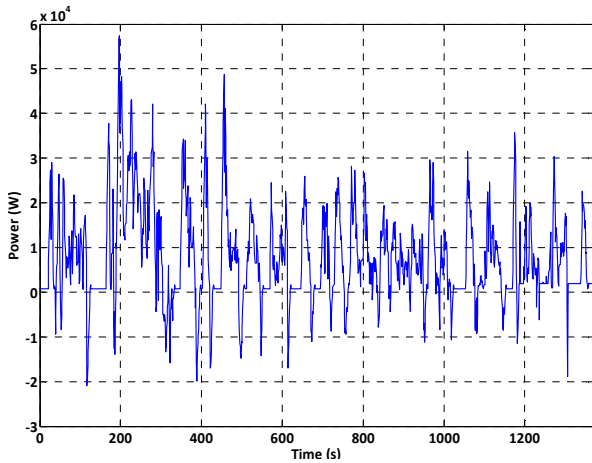

Fig. 2 A lightweight EV power demand by the UDSS

The maximum power demand is 57.4 kW as seen from Fig. 2. PEM FC that is the most suitable FC structure for EVs is chosen as the main source [8].

PEM FC is supported by a lithium-ion battery in order to overcome sudden load demands. The initial state of charge (SoC) value of Lithium-ion battery is 70%. A boost DC-DC converter shown in Fig. 3, is used to raise and regulate the voltage of the FC. The boost converter parameters used in simulation studies are shown in Table I.

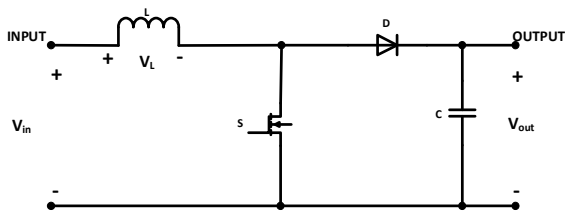

Fig. 3 Boost DC-DC converter

Current control technique in this converter, shown in Fig. 4, is used to limit current.

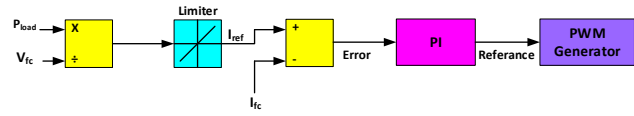

Fig. 4 The control technique of the boost DC-DC converter

Boost DC-DC converter operates with current control and reference current value is calculated from the division of load powers and FC voltage. A current limiter is used to prevent sudden current changes by this way reference current is generated. Reference current is compared with measured FC current and the difference between these currents generates the error value that is processed in PI block and signals which are necessary for PWM generator are generated. Parameters of the boost DC-DC converter is given in Table I.

TABLE I
PARAMETERS OF THE BOOST CONVERTER

Parameters	Value
Converter Inductance	1 [mH]
Converter Capacitance	1 [mF]
Semi-Conductor Type	MOSFET
Average Switching Frequency	20 [kHz]
Proportional gain of the PI current control system	0.01
Integral gain of the PI current control system	0.001

A bidirectional DC-DC converter that shown in Fig. 5, is used to recover the regenerative braking energy to charge the battery and keep the bus voltage constant on 900 V. Bidirectional converter works voltage-controlled. In forward direction, when the DC bus voltage less than 900 V, bidirectional converter works as a boost converter and energy flow is from the battery to DC bus. In the reverse direction, when the bus voltage is more than 900 V, it works as a buck converter and charges the battery.

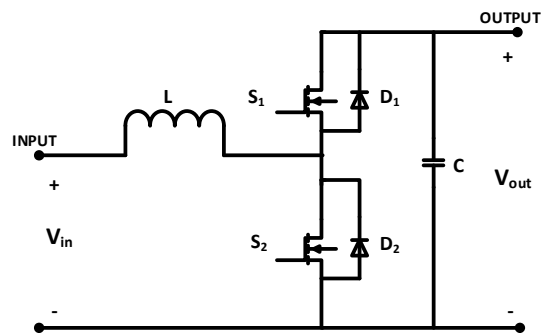

Fig. 5 Bidirectional DC-DC converter

The boost converter parameters used in simulation studies are shown in Table II.

The control technique of the bidirectional DC-DC converter is shown in Fig. 6. Due to the fact that bidirectional converter works voltage-controlled; DC bus voltage is measured and

compared with 900 V. The difference between these values generates error value that is processed in PI blocks. There are two PI blocks because of each one is used for one direction.

TABLE II
PARAMETERS OF THE BIDIRECTIONAL CONVERTER

Parameters	Value
Converter Inductance	1 [mH]
Converter Capacitance	5 [mF]
Semi-Conductor Type	MOSFET
Average Switching Frequency	5 [kHz]
Proportional gain of the PI voltage control system	0.05
Integral gain of the PI voltage control system	0.01
Reference voltage	900 V

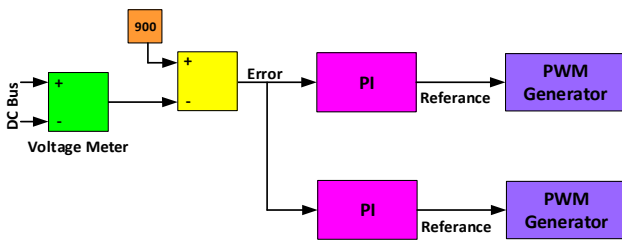

Fig. 6 Bidirectional DC-DC converter's control technique

III. RESULTS

The simulation runs for 1370 seconds with 5 μs sampling time. As described in "Simulation Studies" section, load sharing is provided so as the majority of the vehicle's power demand will be supplied by the FC and instant and negative powers will be supplied by the battery. Under this circumstances, total power and power change of the FC is shown in Fig. 7.

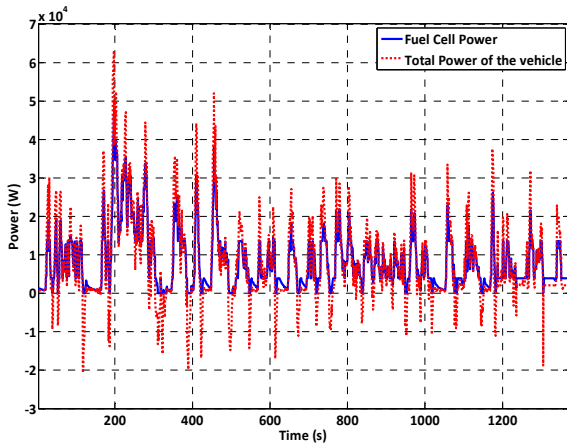

Fig. 7 Graph of total power and power change of the FC

FC power followed the total power demand as shown. However, at the points where the instant changes happened, due to the fact that power change rate is limited; a portion of the power demand was supplied by the battery. The changes in the total power and battery power are shown in Fig. 8.

Although the change in the energy stored by the battery is

very low (72Wh), instant power demands are supplied by the battery. Through the proposed system instant power demands are supplied with the energy gained by regenerative braking. This situation can be observed in Fig. 9 from the same start and end values of the charging rate of the battery.

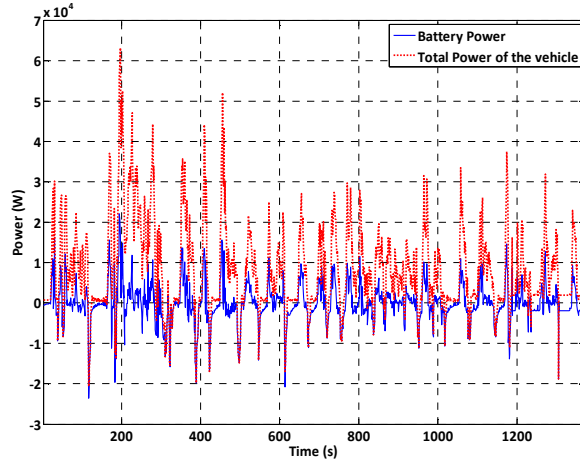

Fig. 8 The power of the battery and changes of total power

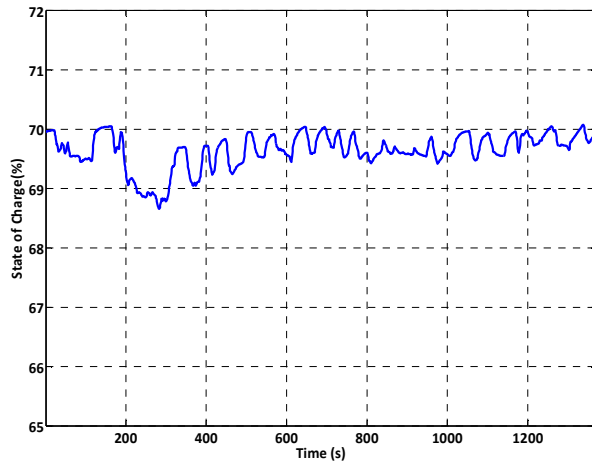

Fig. 9 SoC of the battery during the cycle

The variations in the current and voltage value of the FC during the cycle are shown in Fig. 10. As seen in the figure, when the value of the drawn current is high, FC's voltage is decreasing depending on losses. Thus, at the second 196 where the maximum power is demanded, 73.35 A is drawn from the FC and accordingly voltage of the FC decreases to 633.28 V value.

Similarly, current and voltage changes of the battery are shown in Fig. 11. At the maximum power point in UDDS, battery's current is 42.8 A which is the maximum current value of the battery and battery's voltage is 516 V which is the minimum value of the battery.

Therewithal, while providing power management, DC bus voltage value is maintained at about 900 V, as shown in Fig. 12. Being constant DC voltage will lead to increase the

performance of the power electronics components that connected to the bus.

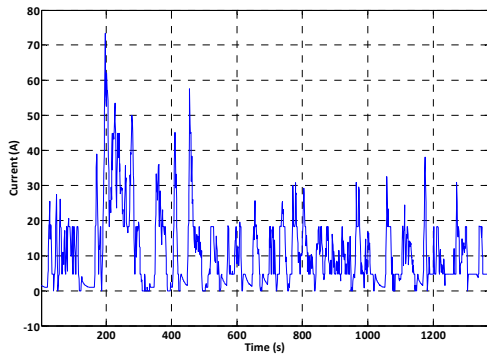

(a)

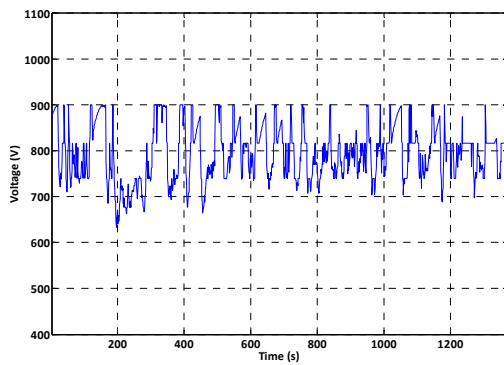

(b)

Fig. 10 Current (a) and voltage (b) of the FC

In order to maintain constant voltage at the DC bus, bidirectional converter that is connected to the battery is forced to drawn current at high frequencies from battery due to the sudden power demand changes. This situation is observed at Fig. 13. The boost converter connected to the fuel cell, supply the bulk of the load current and low frequency current changes can be observed from Fig. 13.

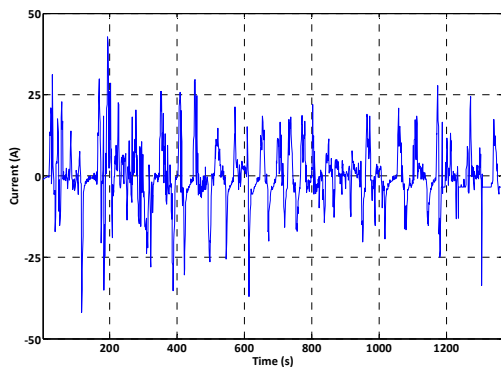

(a)

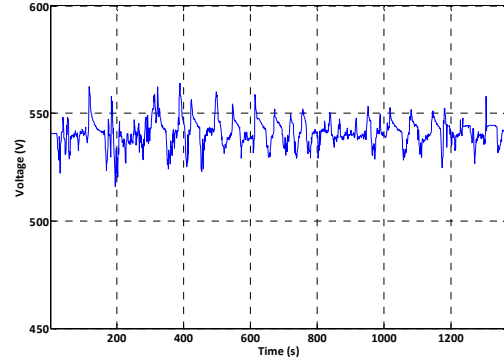

(b)

Fig. 11 Current (a) and voltage (b) of the battery

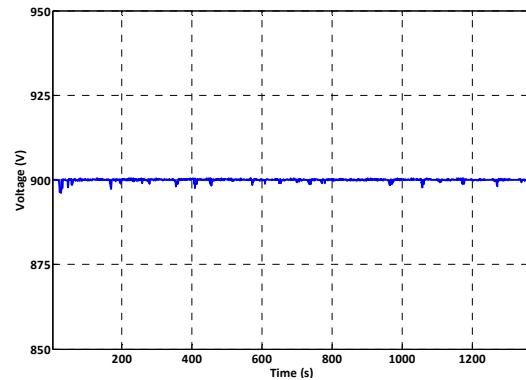

Fig. 12 DC Bus Voltage

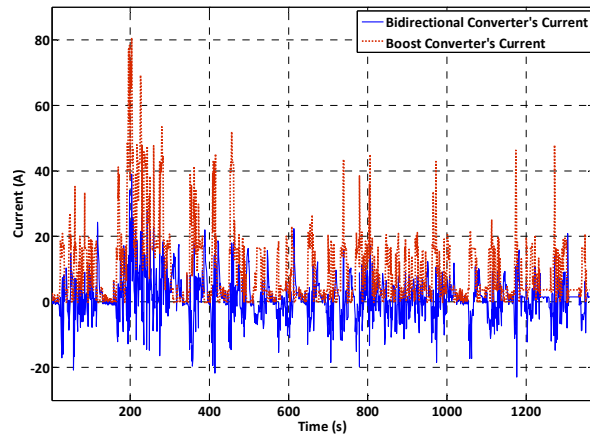

Fig. 13 Current changes of bidirectional and boost converters

IV. CONCLUSION AND SUGGESTIONS

There are many studies about decreasing range problems and increasing performance and efficiency of EVs. The focus of these studies is acquisition of braking energy and providing energy management.

In this study, an energy management strategy which adapted to PEMFC/BAT hybrid electrical vehicle system is carried out. In this system, FC is used to supply main load demand of the system and the battery is used to gain braking energy and supply instant load changes.

When all studies done and obtained results are evaluated, the following suggestions can be done for future studies about EVs;

- In EVs, instead of using FC alone, without an energy storage unit, it is more appropriate using FC with a battery.
- In order to recover braking energy, a bidirectional DC-DC converter is required with the battery. Bidirectional DC-DC converter must be run in at least two modes according to voltage levels.
- In order to increase the lifetime and the efficiency of the energy storage unit in EVs, power sharing should be provided.

REFERENCES

- [1] J. Larminie and J. Lowry, *Electric Vehicle Technology Explained*. West Sussex: John Wiley&Sons, 2003, ch.1.
- [2] B. Vural, "In electric vehicles, the effects of energy management strategies, power converters and hybrid connection topologies on performance and efficiency," Master Thesis, İstanbul, Yildiz Technical University Institute of Science, 2010.
- [3] F. Keskin, "Providing energy management of a fuel cell-battery hybrid electrical vehicle," Master Thesis, İstanbul, Yildiz Technical University, Institute of Science, 2014.
- [4] B Vural, AR Boynuegri, I Nakir, O Erdinc, A Balıkcı, M Uzunoglu, H Gorgun and S Dusmez, "Fuel cell and ultra-capacitor hybridization: A prototype test bench based analysis of different energy management strategies for vehicular applications", *International Journal of Hydrogen Energy*, vol. 35, no. 20, pp. 11161-11171, Oct. 2010.
- [5] N. Bizon, "A new topology of fuel cell hybrid power source for efficient operation and high reliability," *Journal of Power Sources*, vol.196, no.6, pp. 3260-3270, Mar. 2011.
- [6] B. Akin, "Comparison of Single Phase Power Factor Correction Boost Converters for Fast and Efficient Charge of Li-ion Batteries Used in Electrical Cars", *The Journal of Electrical, Electronics, Computer and Biomedical Engineering*, vol. 2, no. 4, pp. 87-93.
- [7] O. Erdinc, "Modeling and analysis of fuel cell/ultra-capacitor hybrid vehicular system using wavelet transform/fuzzy logic based energy management strategy", İstanbul, Yildiz Technical University, Institute of Science, 2008.
- [8] F. Barbir, "*PEM Fuel Cells (Theory and Practise)*", California, Elsevier Academic Press, 2005.

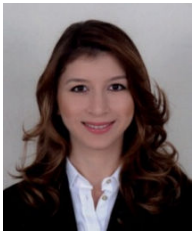

F. Keskin Arabul was born in İstanbul on July 2, 1989, received the Bachelor's degree in electrical engineering and the Master's degree in electric machinery and power electronics from the Department of Electrical Engineering, Yildiz Technical University, İstanbul, Turkey in 2011 and 2014, respectively, where she is currently working toward Ph.D. in electrical engineering.

Since 2013, she has been a Research Assistant in the Electrical Engineering Department, Yildiz Technical University. Her research interests include transformers, electric vehicles and renewable energy systems.