

The Potential of 48V HEV in Real Driving

Mark Schudeleit, Christian Sieg, Ferit Küçükay

Abstract—This paper describes how to dimension the electric components of a 48V hybrid system considering real customer use. Furthermore, it provides information about savings in energy and CO₂ emissions by a customer-tailored 48V hybrid.

Based on measured customer profiles, the electric units such as the electric motor and the energy storage are dimensioned. Furthermore, the CO₂ reduction potential in real customer use is determined compared to conventional vehicles. Finally, investigations are carried out to specify the topology design and preliminary considerations in order to hybridize a conventional vehicle with a 48V hybrid system. The emission model results from an empiric approach also taking into account the effects of engine dynamics on emissions. We analyzed transient engine emissions during representative customer driving profiles and created emission meta models. The investigation showed a significant difference in emissions when simulating realistic customer driving profiles using the created verified meta models compared to static approaches which are commonly used for vehicle simulation.

Keywords—Customer use, dimensioning, hybrid electric vehicles, vehicle simulation, 48V hybrid system.

I. INTRODUCTION

DUE to the limited availability of fossil fuel resources and negative influences of the growing transport sector, legal regulations have been approved to reduce emissions of passenger cars. These targets can be reached by partially electrifying the vehicle's drivetrain. Hybrid Electric Vehicles (HEV) also allows meeting future requirements and they are expected to bridge the gap to Battery Electric Vehicles. For this reason, there are many types of HEV with very different drivetrain layouts. Existing HEV commonly show a high degree of hybridization, e.g. Full HEV or Plug-In HEV, and are based on existing vehicle designs. They enable high electric ranges and offer different operating modes. Although these HEV are ecologically beneficial and possess high driving dynamics, they are not competitive with conventional vehicles since their development and fabrication processes are more expensive. Electrical components as well as batteries have to be integrated into the vehicle. In addition, an operating strategy has to be developed. Thus, it is impossible to retain the vehicle design and the price at the same time.

A low priced system that offers most of the functionalities of a Full HEV/ PHEV seems to be very advantageous since it is expected to show a high potential of CO₂ emission reduction. It is integrated into the vehicle in the form of an

M.Sc. Mark Schudeleit is with the Institute of Automotive Engineering, Braunschweig University of Technology, 38106, Braunschweig, (corresponding author, phone: 0049-531-391-2656; e-mail: m.schudeleit@tu-bs.de).

B.Sc. Christian Sieg and Prof. Dr.-Ing. Ferit Küçükay are with the Institute of Automotive Engineering, Braunschweig University of Technology, 38106, Braunschweig, Germany, (e-mail: c.sieg@tu-bs.de, f.kuecuekay@tu-bs.de).

add-on. Some components are available at component suppliers, others only have to be developed and produced. Hence the vehicle can be developed and produced in an economical way.

To be able to use different operating modes, e.g. load point shift or braking energy recuperation, the vehicle's board net needs to be modified. An additional voltage level of 48V is recommended to ensure adequate braking energy recuperation at high efficiency [1]. A voltage below 60V is chosen to avoid high extra cost due to safety measures regarding regulation ECE-R-100 [2]. Furthermore, an electrical supply system operating at 48V offers higher maximum power compared to a conventional 12V supply system [2], which is reaching its limits as a result of an increasing demand of additional safety and comfort features.

It is known that various ideas pursuing different approaches of 48V HEV already exist. They mainly differ in the positioning of the Starter Generator (SG). Either a belt-driven system [3] or a crankshaft mounted concept is possible [4]. Furthermore, the electric motor can be integrated into the transmission [5].

The purpose of this study was to be able to build up a demonstration vehicle by developing a 48V HEV layout. Data from test drives in customer use were analyzed in order to correctly dimension the electric components. A simulation model in MATLAB / Simulink was created to determine the vehicle's emissions and fuel consumption in cycle and customer use in detail.

II. DETERMINATION OF REQUIREMENTS AND POTENTIALS OF A 48V HYBRID SYSTEM BASED ON MEASUREMENT DATA ANALYSIS OF REAL CUSTOMER USE

A. Approach

Research has shown that the pulley starter generator is beneficial for add-on concepts. In order to dimension the key components of this system as well as identifying the CO₂ reduction potential in customer use, an analysis of customer measurement data is necessary.

First, the energy demand to overcome driving resistances is calculated for different driving cycles. This allows to identify the theoretical recuperation potential for a medium-sized vehicle and to define requirements for the 48V hybrid system as well as the powertrain concept (combustion engine, transmission and driving axle).

The gained knowledge of the vehicle parameters enables to dimension the electric motor on the maximum recuperation power and the capacity of the battery to optimally exploit the recuperation potentials in real customer use. In consideration of all findings, the theoretical CO₂ reduction potentials are calculated for the various hybrid functions of the 48V system.

B. Preliminary Considerations of the Recuperation Potential in the 3D Parameter Space

The 3D parameter space consists of the three parameters driver, driven vehicle and driving environment. The drivers are divided into a mild, average and sporty driving style, where the driving environment distinguishes between urban,

extra-urban and freeway and mountain roads. Furthermore, the weight of the driven vehicle can be changed from light to middle, full or fully loaded with trailer. This concludes in 48 combinations, which span an area of use. In this paper, the measurements were done for nine different, but most common combinations, which will be analyzed.

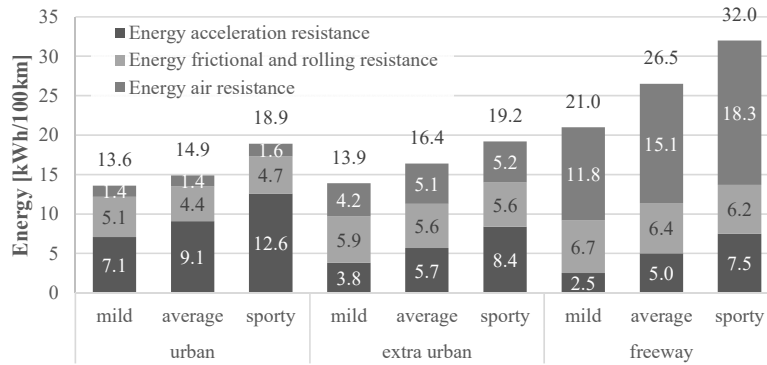

Fig. 1 Cycle-dependent energy demand in the traction phase due to driving resistances

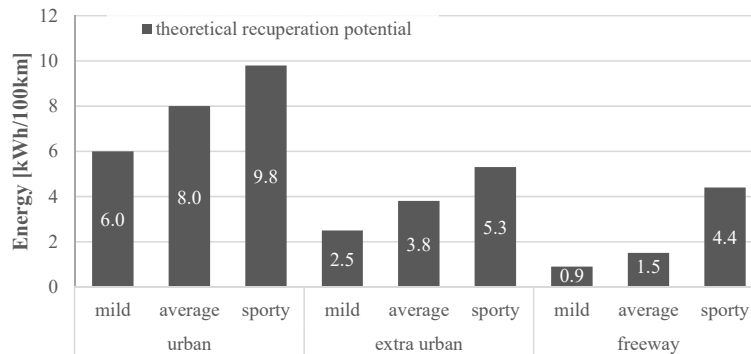

Fig. 2 Theoretical recuperation potential in customer use

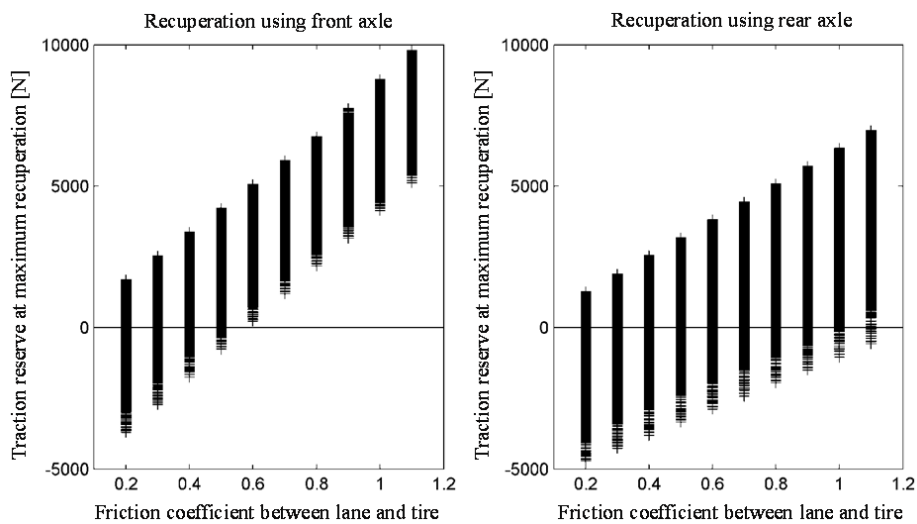

Fig. 3 Comparison of the traction reserve in urban driving with various friction coefficients [6]

From measured data and vehicle parameters (Table I), the energy demand to overcome the driving resistances as well as

the traction force demand can be calculated. The results are presented in Fig. 1.

TABLE I
VEHICLE PARAMETERS

Parameter	Symbol	Quantity
Vehicle mass	m	1500 kg
Drag coefficient	$c_d \times A$	$0.3 \times 2.3 \text{ m}^2 = 0.69 \text{ m}^2$
Factor for additional rotational mass	λ	1.1
Rolling resistance coefficient	f_r	9×10^{-3}
Frictional force (wheel bearings and residual torque)	F_{FR}	40 N

Fig. 1 illustrates that the energy demand of the individual and the total driving resistances in the traction phase of the vehicle depends significantly on the respective customer.

The highest energy demand occurs for freeway driving, among other reasons due to the high value of air resistance. Due to the frequent starts and acceleration maneuvers in urban driving, the relative shares as well as the absolute shares of the acceleration energy are the highest there. A sporty driving style in urban areas particularly results in an acceleration energy share of 67%. The frictional and rolling resistance losses in the traction phase differ slightly due to the different share of traction and thrust phase for each customer – assuming that the frictional and rolling resistances remain always the same in both phases. From this data, the theoretical recuperation potentials of the considered customers can be derived (Fig. 2). The theoretical recuperation potential is the acceleration energy in the traction phases minus the irreversible driving resistances in the thrust phases.

The results reveal that the urban driving cycles have the highest recuperation potential, from 6.0 kWh/100km to 9.8 kWh/100km (44% to 53% of the energy used for propulsion). In contrast, the energy which can be theoretically recuperated on freeways is between 4% and 14% of the entire energy on wheel level which is 0.9 kWh/100km to 4.4 kWh/100km. From this analysis it can be concluded that the quantifiable benefit of the recuperation function of hybrid vehicles heavily depends on the customer and the purpose the vehicle is used for – where the potentials are the highest in the city and while driving sporty. The customer-oriented dimensioning of the drivetrain described in the following is based on these results.

C. The Concept Car

Analyses show that particularly vehicles of the C and D segment with turbocharged gasoline engines and double clutch transmission are suitable for 48V hybridization. For the selection of the drive topology (front axles vs. rear axle), it is important to analyze the maximum transmittable force for recuperation between tire and road while taking the dynamic axle load distribution during deceleration into account.

Fig. 3 shows the comparison of the traction force reserve for deceleration in a real urban cycle with varying friction coefficients. Low coefficients of friction result in exceeding the maximum traction force potential (below 0) on both axles and, therefore, a loss in the recuperation potential due to ABS intervention. Considering that the front drive reaches the traction force limit with friction coefficients under 0.5 (aquaplaning) whereas the rear drive exceeds it at $\mu < 1.1$ (dry

road, asphalt), the front wheel drive is more suitable when braking recuperative.

III. DIMENSIONING OF THE ELECTRICAL COMPONENTS OF THE 48V HYBRID SYSTEM

On the basis of the analysis of the theoretical recuperation potential, the size of the electric motor can be calculated. The additional 48V system components (battery, controller, inverter, cable) are assumed to be about 50 kg.

A. Electric Motor

About 50% of the recuperative braking energy should be recuperated by the 48V system in customer use to enable full 48V functionalities. In the calculation, the reduction of the potential due to the engine drag torque must be considered, resulting in (1) and (2). Furthermore, recuperation does not take place at a vehicle speed below 3 m/s as the clutches will be opened.

$$P_{brake} = -P_{acc} - (P_{air} + P_{frict} + P_{drag}) \quad (1)$$

$$W_{brake} = \int_0^T P_{brake} * dt \quad (2)$$

Table II shows the results of the recuperative braking energy and the required motor power for the nine selected customers.

TABLE II
BRAKING ENERGY AND REQUIRED POWER FOR RECUPERATION

Driving environment	Driving style	Braking energy W_{brake} [kWh/100km]	Required power for recuperation (50%) [kW]
urban	mild	3.17	6
	average	4.17	7.1
	sporty	4.81	11.1
extra urban	mild	1.34	8.5
	average	2.32	12.3
	sporty	2.96	22.8
freeway	mild	0.5	11.8
	average	0.95	19.4
	sporty	3.5	54

The highest potential of braking energy recuperation is expected for urban driving. Moreover, the driving profile “freeway, sporty driving” lead to high braking power and energy due to high deceleration. However, a 54 kW motor is necessary in order to recuperate this energy, whereas during mild urban driving only a 6kW motor is needed to recuperate 50% of the braking energy. The mean value of 11.8 kW seems to be realistic as a maximum motor power for 48V motors.

B. Dimensioning of the 48V Battery

Another important component to focus on is the 48V battery. Due to the high costs for batteries and the increasing weight and installation space according to its capacity, the traction battery should be as small as possible. At the same time, it needs to be considered that the capacity available is sufficient to store as much braking energy as possible during recuperation, to exploit the full fuel saving potential by using

it for starting and creeping electrically as well as boosting. Thus, different customer simulations were done with battery capacities varying between 0.1 kWh and 0.5 kWh.

Based on time data of the SOC (maximum and minimum), the required capacity can be determined. The approach is pictured in Fig. 4 for an average urban driver.

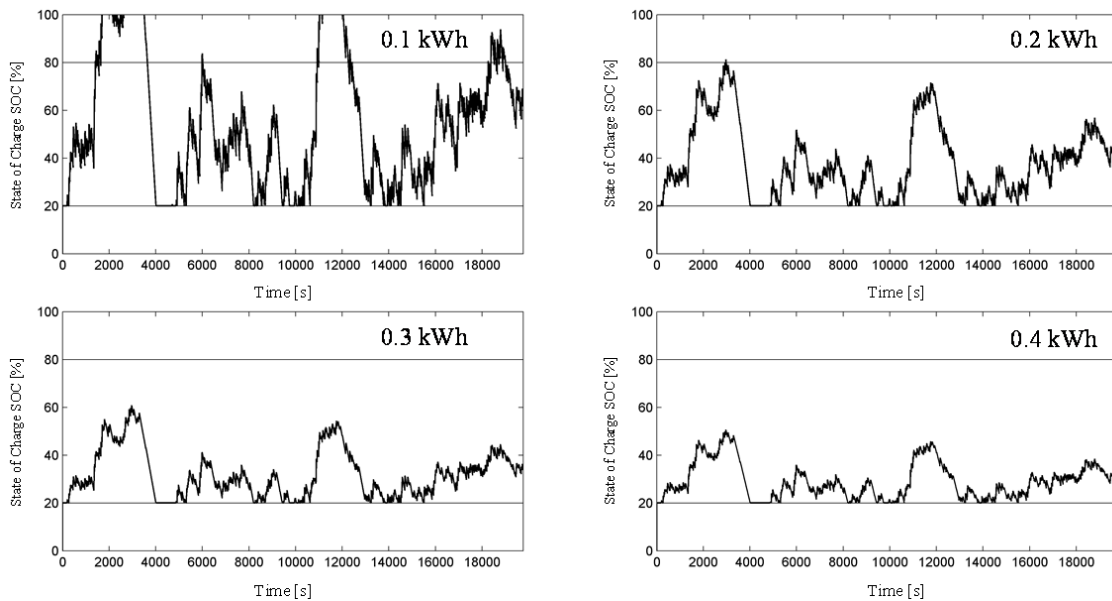

Fig. 4 Time data of the SOC for different battery capacities (urban environment, average driver) [6]

The required battery capacities for all considered driving profiles is illustrated in Table III.

TABLE III
REQUIRED BATTERY CAPACITY FOR VARIOUS CUSTOMER DRIVING PROFILES

Driving environment	Driving style	0.1 kWh	0.2 kWh	0.3 kWh	0.4 kWh	0.5 kWh
urban	mild	X	✓	✓	✓	✓
	average	X	✓	✓	✓	✓
	sparty	✓	✓	✓	✓	✓
extra urban	mild	X	✓	✓	✓	✓
	average	X	X	X	X	✓
	sparty	✓	✓	✓	✓	✓
freeway	mild	✓	✓	✓	✓	✓
	average	X	✓	✓	✓	✓
	sparty	X	✓	✓	✓	✓

The profile “extra-urban, average driver” is the most critical due to the dimensioning of the battery. The trade-off of high costs for batteries and a nonetheless adequate energy storing reserve for long recuperation phases results in a minimum capacity of about 0.3 kWh.

IV. EVALUATION OF THE CO₂ REDUCTION POTENTIAL IN CUSTOMER USE DUE TO A 48V SYSTEM

When determining the CO₂ reduction potential of a 48V hybrid system by simulation, the hybrid functions recuperation, engine start-stop and coasting play an important role. Minor potentials, such as load point shift, are not considered.

TABLE IV
CO₂ REDUCTION POTENTIAL OF ENGINE START-STOP

Driving environment	Driving style	Idling time	Reduction	
		(v=0)/100 km [s]	Liter/100 km	g CO ₂ /km
urban	mild	2618	0.58	13.4
	average	4351	0.97	22.3
	sparty	3209	0.71	16.5
extra urban	mild	306	0.07	1.6
	average	486	0.11	2.5
	sparty	757	0.17	3.9
freeway	mild	122	0.03	0.6
	average	139	0.03	0.7
	sparty	59	0.01	0.3

A. CO₂ Reduction Potential Due to Engine Start-Stop

Measurements show that the fuel consumption at idle (1.4l, 90kW) can be assumed as 0.8 l/h. Using the CO₂ equivalent of 2.309g CO₂/liter, the CO₂ reduction is calculated as shown in Table IV. As expected, engine start-stop offers the highest reduction potential in urban environments due to the high percentage of idling. In extra urban and freeway use, the fuel savings are rather small.

B. CO₂ Reduction Potential Due to Coasting

Coasting with switched off engine is another available function of a 48V hybrid. The theoretical CO₂ reduction potential is calculated in the same way as the engine start-stop potential. In MATLAB, the cycle-related time is calculated in which the vehicle moves at a speed above 0 without any engine load and without brake actuation. The results are shown in Table V. Coasting time is identified to be between 1933s/100km in urban use and 226s/100km on freeways. This

leads to a CO₂ reduction from 9.9g CO₂/km (urban environment) to 1.2g CO₂/km (freeway).

TABLE V
CO₂ AND FUEL REDUCTION POTENTIAL DUE TO COASTING FUNCTION

Driving environment	Driving style	Coasting time (v>0)/100 km [s]	Reduction	
			Liter/100 km	g CO ₂ /km
urban	mild	1367	0.3	7
	average	1933	0.43	9.9
	sporty	1489	0.33	7.6
extra urban	mild	624	0.14	3.2
	average	706	0.16	3.6
	sporty	538	0.12	2.8
freeway	mild	226	0.05	1.2
	average	360	0.08	1.8
	sporty	389	0.09	2

C. CO₂ Reduction Potential Due to Recuperation

According to the results of Section IV, where a 12kW starter generator is found to be the most suitable for the 48V hybrid system, the real cycle-related CO₂ recuperation potential of a 48V hybrid can be calculated. Assuming an average combustion engine efficiency of about 30% and a gasoline engine density of 8.75 kWh/l leads to the results illustrated in Table VI for the different customer cycles. In an urban driving environment, up to 3 kWh/100km can be saved by recuperating the braking energy with a 12kW starter generator (over 20g CO₂/km) when using it for propulsion afterwards. In an extra-urban environment, the 48V hybrid system reduces emissions up to 10g CO₂/km (average driver), whereas on freeways an improvement of less than 5g CO₂/km can be expected.

D. Full CO₂ Reduction Potential

Fig. 5 shows the full CO₂ reduction potential of a 48V hybrid system as a sum of the potential of engine start-stop, coasting and recuperation. In real customer driving, the range of CO₂ reduction goes from 4.1 g CO₂/km (mild driver on freeway) to 58.5 g CO₂/km (average driver in urban areas). This is equal to fuel reduction between 0.18l/100km and 2.53l/100km. On average – assuming that all driving styles and driving environments have the same share – 22.8g CO₂/km can be saved (0.99l/100km gasoline). Solely the hybrid functions of recuperation and coasting lead to savings about 15.9g CO₂/km (0.69l/km gasoline). Related to the considered conventional vehicle with a consumption of 7.01l/100km (with start-stop) in real driving, the 48V hybrid system allows additional savings in fuel of about 10% in real customer use.

TABLE VI
CO₂ AND FUEL REDUCTION POTENTIAL DUE TO RECUPERATION FUNCTION
(12KW STARTER GENERATOR)

Driving environment	Driving style	Recuperation potential [kWh/100 km]	Reduction	
			Liter/100 km	g CO ₂ /km
urban	mild	2.46	0.94	21.7
	average	2.98	1.14	26.3
	sporty	2.32	0.88	20.3
extra urban	mild	0.87	0.33	7.6
	average	1.14	0.43	9.9
	sporty	0.93	0.35	8.1
freeway	mild	0.26	0.1	2.3
	average	0.33	0.13	3
	sporty	0.52	0.2	4.6

V. EVALUATION OF A 48V HYBRID ELECTRIC VEHICLE REGARDING ENERGY CONSUMPTION AND POLLUTANT EMISSIONS IN CYCLE AND CUSTOMER USE

In this chapter, simulation results are presented. The use of a conventional vehicle and a 48V HEV with a belt-driven starter generator was simulated. To determine savings in energy consumption and emissions provided by a 48V HEV, the operation of a conventional vehicle was additionally simulated. Both drivetrain concepts were compared and saving potentials in emissions, fuel and energy consumption were determined.

First, the vehicles' energy consumption (tank-to-wheel) was divided into the amount of energy to overcome driving resistances and to compensate drivetrain losses. The energy needed to overcome driving resistances can be further broken down and the cycle-specific theoretical and practical recuperation potential can be examined.

Second, the vehicle's CO₂ emissions in cycle and customer use were determined.

A. Energy Consumption

By simulating cycle and customer use, both vehicles' energy consumption was determined. To be able to evaluate the efficiency of both drivetrain concepts, the energy to compensate drivetrain losses and the energy to overcome driving resistances are displayed and compared for each driving cycle. Since the 48V HEV is able to partially recuperate braking energy, the energy consumption (tank-to-wheel) can be lowered by a certain recuperation potential. Before simulation results are presented, the following section describes how the 48V HEV's recuperation potential can be determined.

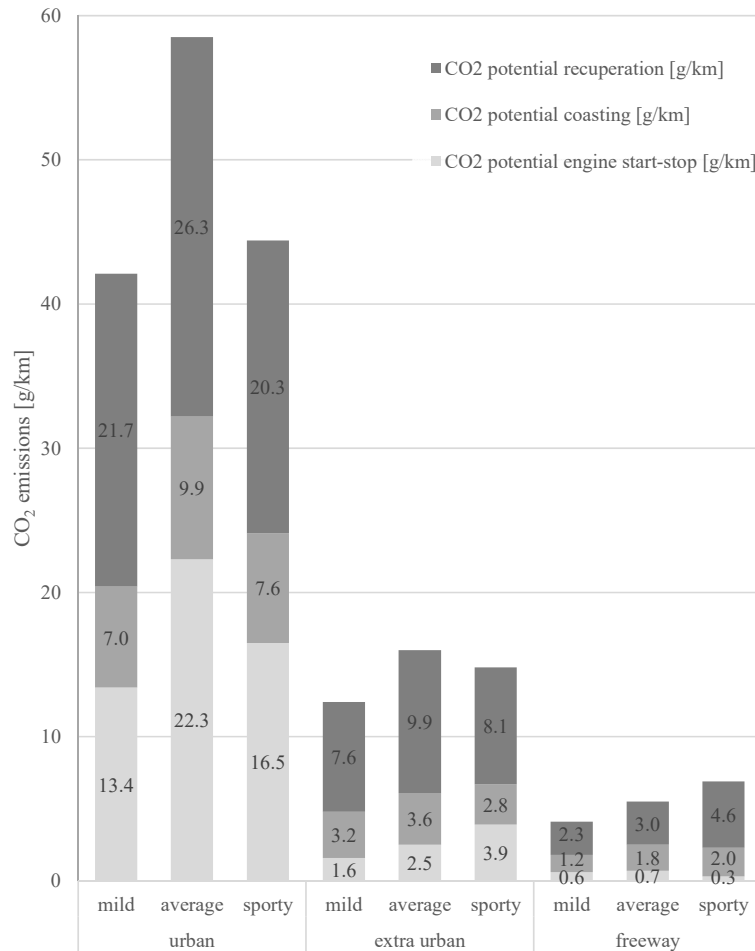

Fig. 5 Full CO₂ reduction potential of a 48V hybrid system in customer use

B. Determination of the Practical Recuperation Potential of 48V HEV

The 48V HEV's recuperation potential is influenced by the shares of energy needed to overcome driving resistances. This energy can be broken down into four shares: energy to overcome air, acceleration, rolling and frictional resistance. When braking, it is possible to recuperate a certain amount of energy since the electric motor, then serving as a generator, can apply a braking torque resulting in a negative acceleration. The amount of energy which can be recuperated is not equal to the share of energy needed to overcome the acceleration resistance in traction phase since air, rolling and frictional resistance in the thrust phase add to the deceleration of the vehicle and therefore lower the vehicle's theoretical recuperation potential.

The theoretical recuperation potential described above can partially be stored in a battery so that it can be retrieved later. Due to resistive and mechanical losses between electric motor and battery, it is not possible to store the complete theoretical recuperation potential in the battery. When this energy is retrieved from the battery and used for propulsion, it is lowered by mechanical and resistive losses again. The resulting amount of energy is called practical recuperation

potential and should be taken into account when comparing energy balances of different vehicles.

C. Energy Consumption (Tank-to-Wheel): Cycle Operation

Fig. 6 displays the energy consumption (tank-to-wheel) for the 48V HEV and the conventional vehicle in cycle operation. This energy can be divided up into a share to overcome driving resistances and a share necessary to compensate drivetrain losses.

The 48V HEV's share of energy required to overcome driving resistances slightly differs from the conventional vehicle's share since it depends on vehicle parameters such as vehicle mass or air drag coefficient. As a result of an additional mass of 50 kg, the 48V HEV consumes more energy to overcome driving resistances when its practical recuperation potential is not taken into account.

Since the 48V HEV's drivetrain operates with a higher efficiency, the share of drivetrain losses decreases compared to a conventional vehicle. Hybrid functions such as load-point-shift or electric drive either allows to increase the internal combustion engine's efficiency or to propel the vehicle only by an electric motor operating with a notably higher efficiency and therefore lowering drivetrain losses.

In the NEDC, an energy consumption of 41.6 kWh/100km is achieved by the 48V HEV though consumption increases by 2.8 kWh/100km in case of a conventional vehicle. A reduction of about 15% which equals 7.1 kWh/100km can be expected in the FTP75 when hybridizing the drivetrain. Operating in the

JP015mode, the 48V HEV consumes 38.8 kWh/100km (or 13.6%) less energy than the conventional vehicle. In the WLTP, the energy consumption of the 48V hybrid is 6.9% lower than of a comparable conventional vehicle.

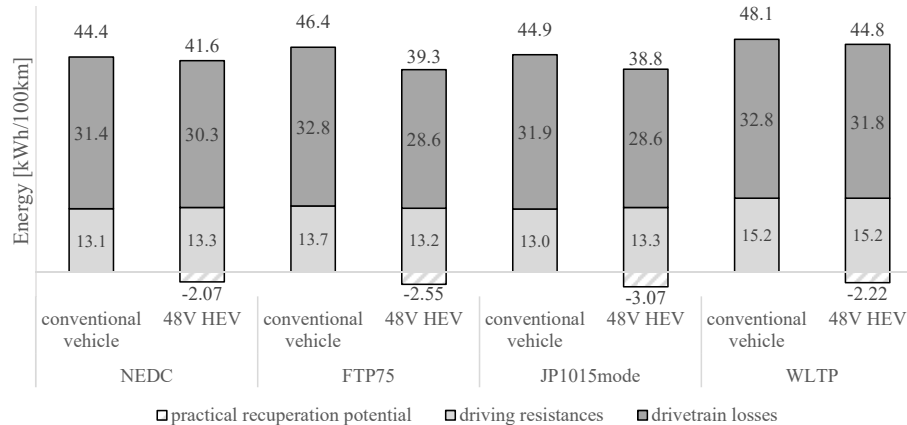

Fig. 6 Energy consumption (tank-to-wheel) of conventional vehicle and 48V HEV in cycle operation

D. Energy Consumption (Tank-to-Wheel): Customer Use

In Fig. 7, the energy to overcome driving resistances and drivetrain losses is subsumed under the energy consumption (tank-to-wheel) for customer use for both a 48V HEV and a conventional vehicle. Depending on driving environment and driving style, the energy saving potential differs among all cycles.

Whereas the 48V HEV consumes significantly less energy than the conventional vehicle under urban driving conditions, the saving potential of energy consumption (tank-to-wheel) decreases when driving extra urban. On freeways, the 48V HEV requires a slightly higher share of energy to compensate drivetrain losses leading either to an increased or only slightly decreased demand of energy. In case of an extra urban driving environment, the shares of energy lost in the drivetrain is lower than in urban driving cycles supposing the driving style remains equal. We can conclude that the driving environment has a strong influence on the saving potential of energy consumption.

The influence of the driving style differs among all driving environments. Under urban driving conditions, the driving style's influence on the energy consumption (tank-to-wheel) is most obvious. The energy required to overcome driving resistances increases from a mild to a sporty driving style due to a higher share of energy necessary to overcome acceleration resistances. At the same time, this increased acceleration resistance leads to a higher recuperation potential. The energy needed to compensate drivetrain losses increases from a mild to a sporty driver.

Considering extra urban driving cycles, the driving style has a minor effect on the saving potential of energy consumption compared to urban driving cycles.

Since the overall energy consumption (tank-to-wheel) regarding freeway driving cycles only marginally differs, the driving style does not affect the corresponding savings of energy consumption.

From Fig. 7, it can be inferred that 48V hybridisation is most beneficial in urban driving environments since the vehicle's drivetrain is able to operate with a higher efficiency. Thus, the share of energy required to compensate drivetrain losses notably declines compared to a conventional vehicle. In addition, the 48V hybrid offers the highest practical recuperation potential under urban driving conditions due to a higher number of acceleration and braking maneuvers. When driving extra urban, the 48V HEV's energy consumption is lower, but the savings in energy consumption decrease. In case of driving on freeways, a 48V hybridization of the drivetrain is not beneficial regarding energy consumption.

E. CO₂ Emissions

The overall emissions of carbon dioxide (CO₂) were determined in cycle and customer use for both vehicles and are compared in the following section.

F. Evaluation of CO₂ Emissions in Cycle Operation

Fig. 8 shows the CO₂ emissions of a conventional vehicle in comparison to a 48V hybrid in the NEDC, FTP75, JP1015mode and WLTP cycles. In general, the conventional vehicle produces more emissions of carbon dioxide than a 48V HEV regarding all driving cycles. The highest savings in emissions can be achieved in the Federal Test Procedure 75 cycle where approximately 15.4% less CO₂ is emitted. Operating in the WLTP, the 48V HEV's emissions are about 6.8% lower compared to a conventional vehicle whereas about 6.3% and 13.5% of savings can be expected in the NEDC and JP1015mode.

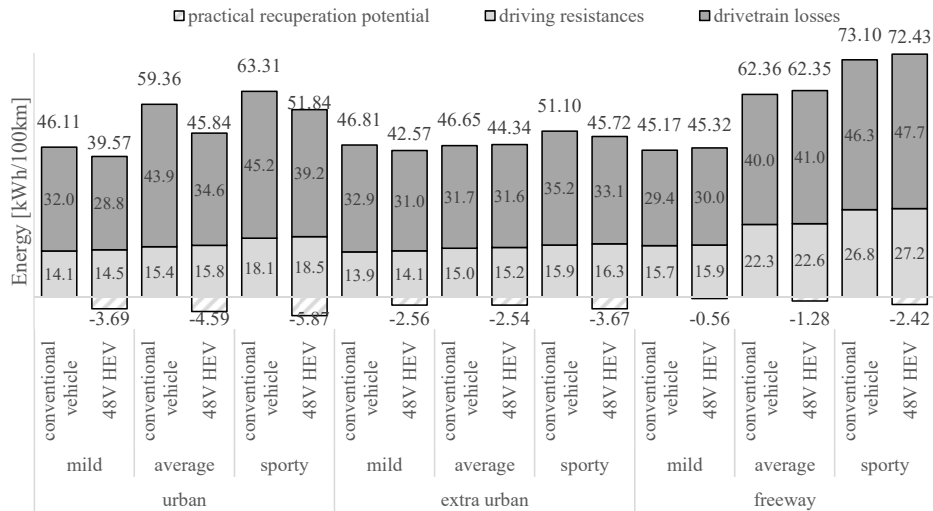

Fig. 7 Comparison of energy consumption (tank-to-wheel) for 48V HEV and conventional vehicle

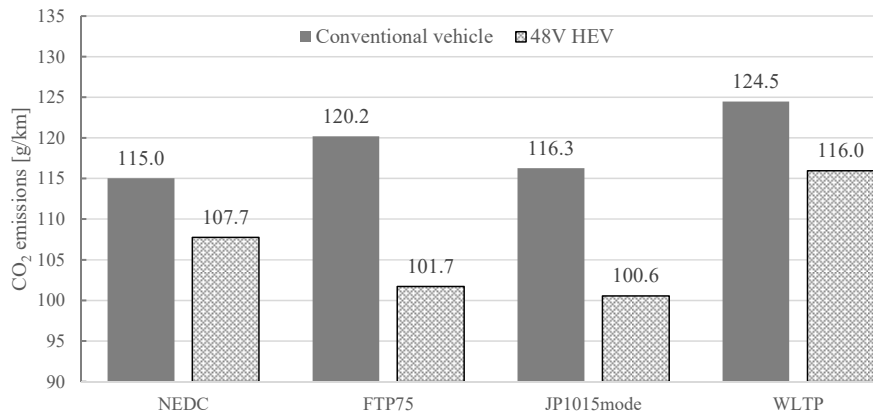

Fig. 8 Emissions of carbon dioxide for 48V HEV and conventional vehicle in cycle operation

The main reason for lower overall CO₂ emissions of the 48V HEV is the electric drive allowing cutting off the ICE and driving locally emission-free for short times. Another reason is that the combustion engine is running with a higher efficiency when performing a load point shift so that less CO₂ is emitted.

The ratios of savings in carbon dioxide emissions among these driving cycles differ.

G. Evaluation of CO₂ Emission in Customer Operation

Emissions of carbon dioxide in customer operation are shown in Fig. 9. In general, the conventional vehicle's level of CO₂ emissions is higher, but the savings achieved with a 48V HEV distinctly differ among the driving cycles. Whereas the 48V hybrid operating under urban driving conditions emits approximately 14% to 23% less CO₂ than a conventional

vehicle, only marginal savings of CO₂ emissions can be expected when driving on freeways. In case of a mild driving style, the CO₂ emissions slightly increase when driving on freeways. The main reason for this is that electric drive is available more often in cycles with lower speeds and less required driving power.

VI. CONCLUSION

This paper introduced a method to evaluate the potential of 48V system in vehicles in customer use by analyzing customer measurement data while driving.

Based on the results of customer data for a pulley starter add-on concept, a size of the electric motor and the 48V battery is proposed.

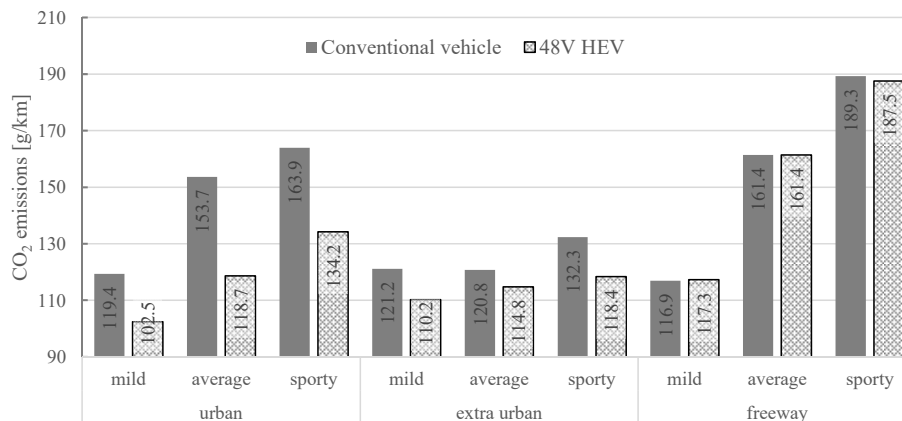

Fig. 9 Carbon dioxide emissions in customer use for 48V HEV and conventional vehicle

It has been found that the theoretical recuperation potential (without efficiency losses), which results from braking, is the highest when driving in urban areas. Depending on the driving style (mild, average, sporty), 6.0 kWh/100km to 9.8 kWh/100km (44% to 53% of the energy used for propulsion) has been calculated. In contrast, 0.9 kWh/100km to 4.4 kWh/100km can be expected on the freeway, which is between 4% and 14% of the entire energy at the wheel. Based on this, the optimal size of the electric motor and the 48V battery was determined.

In order to recuperate 50% of the theoretical braking energy, between 6kW (mild driver, urban roads) and 54kW (sporty driver, freeway) are necessary. The first one would not exploit the saving potentials in different customer uses, whereas the latter one would lead to an over-dimensioning of the vehicle. Thus, the mean power of all customers – 11.8 kW – has been taken as a basis, as it recuperates more than 50% of the braking energy on urban roads with a mild driving style.

The 48V battery size has been identified by simulating the vehicle and varying the capacity of the battery. Hence, the minimum capacity, also for long recuperation phases, results in about 0.3 kWh.

In cycle operation, the highest savings in CO₂ emissions can be achieved in the FTP75 where approximately 15.4% less CO₂ is emitted compared to operating in the WLTP, the 48V HEV's emissions are about 6.8% lower compared to a conventional vehicle whereas about 6.3% and 13.5% of savings can be expected in NEDC and JP1015mode.

Whilst the 48V hybrid operating under urban driving conditions emits approximately 14% to 23% less CO₂ than a conventional vehicle, only marginal savings of CO₂ emissions can be expected when driving on freeways.

To sum it up, 48V systems in vehicles can lead to significant savings in fuel economy and CO₂ emissions while being highly affordable. In customer use, depending on the driving style and the driving environment in which the vehicle is operated, the saving potential can be even higher compared to legislated driving cycles.

APPENDIX: SIMULATION MODEL

The simulation model in MATLAB/Simulink consists of the sub-models *driver*, *driving environment* and *driven vehicle*, which interact with each other.

A. Driver Model and Environment Model

The driving specifications in customer use, such as target speed (also known as orientation speed profile) and speed gradients are generated by a statistical orientation speed generator using the 3D database. The statistical driver model tries to reach this given orientation speed profile (OSP) – a rectangle course – by using the driving pedals. The driver model also comprises a statistical database with vehicle, driving style and route specific actions of the driver, like driving pedal gradients and its final position during a maneuver [7].

In cycle simulation, the driver and driving environment models are replaced by a driving guideline model, which contains a driving speed controller. Its purpose is to control the accelerator and braking pedal position according to the speed difference of the actual and the desired speed, in order to follow the given speed-time course of a driving cycle.

B. Vehicle Model

The modeled vehicle used for the studies is a 48V hybrid electric vehicle (HEV) with parallel, torque adding topology and front-wheel-drive (Fig. 10). In addition to an internal combustion engine (ICE) and a non-manual transmission, the drivetrain consists of an electric motor (EM) integrated into the combustion engine's belt drive serving as a starter generator.

C. Operating Strategy

The operating strategy of the simulated HEV is displayed in Fig. 11. It selects the actual operating mode according to the state of charge (SOC) of the battery, the driving power (P) and the vehicle's speed (v). Available hybrid operation modes are recuperation, electric driving (EM), ICE driving (ICE) and load point shift (LPS). In the latter mode, an intelligent fuzzy logic controller controls the torque distribution between ICE and EM through numerous rules depending on various input

parameters and fulfills the load point shifting as well as boosting. Since ICE and EM are permanently connected, the EM needs to overcome the ICE's drag torque during electric driving; thus, this operating mode is only available at low speed. Transition areas with a hysteresis are implemented to avoid alternating between two operating modes.

- [6] J. Mohrmann, "Design of a 48V Micro Hybrid System", master thesis, Braunschweig University of Technology, Institute of Automotive Engineering, 2014.
- [7] J. P. Müller-Kose, "Representative Load Spectra for Vehicle Gearboxes", Shaker Verlag, Aachen, 2002.

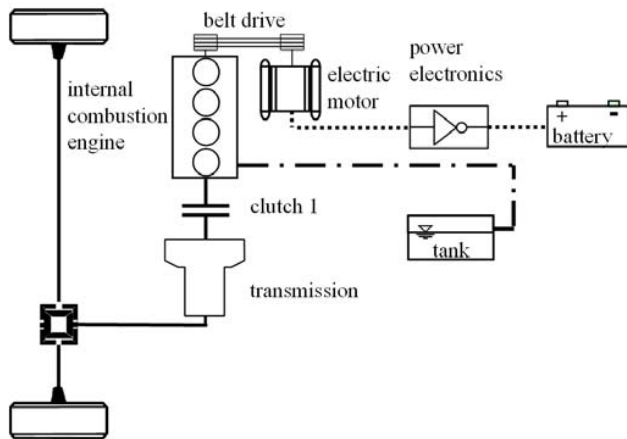

Fig. 10 48V HEV topology

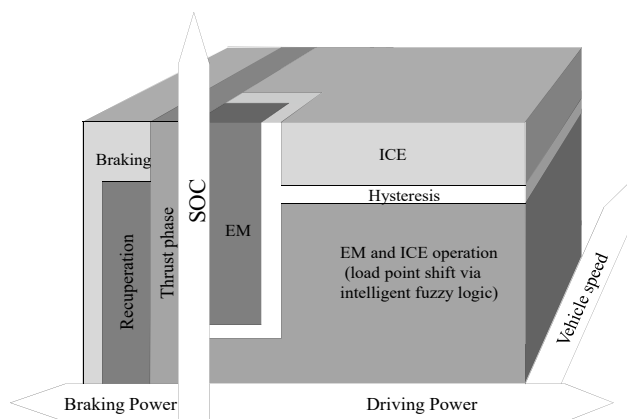

Fig. 11 Operating strategy based on driving power, SOC and vehicle speed

REFERENCES

- [1] M. Nalbach, A. Körner, C. Hoff, "Potential and Components of 48V Low Cost Hybrid Vehicles", Intelligent Transport Systems, 10th Symposium Hybrid and Electric Vehicles, Braunschweig, 2013.
- [2] T. Dörsam, S. Kehl, A. Klinkig, A. Radon, O. Sirch, "Die neue Spannungsebene 48V im Kraftfahrzeug", in ATZelektronik, vol. 7, no. 1, pp. 20-25, 2012.
- [3] R. Schmid, W. Hackmann, P. Birke, M. Schiemann, "Design of a 48V-Belt driven Starter Generator-System drawing special system requirements into account", Intelligent Transport Systems, 10th Symposium Hybrid and Electric Vehicles, Braunschweig, 2013.
- [4] A.K. Jain, S. Mathapati, V.T. Ranganathan, V. Narayanan, "Integrated Starter Generator for 42-V Powernet Using Induction Machine and Direct Torque Control Technique", IEEE Transactions on Power Electronics, vol. 21, no. 3, pp. 701-710, 2006.
- [5] U.C. Blessing, J. Meissner, M. Schweiher, T. Hoffmeister, "Scalable Hybrid Dual-clutch Transmission", in ATZ worldwide, vol. 116, no. 12, pp. 4-9, 2014.