

# A Consideration on the Offset Frontal Impact Modeling Using Spring-Mass Model

Jaemoon Lim

**Abstract**—To construct the lumped spring-mass model considering the occupants for the offset frontal crash, the SISAME software and the NHTSA test data were used. The data on 56 kph 40% offset frontal vehicle to deformable barrier crash test of a MY2007 Mazda 6 4-door sedan were obtained from NHTSA test database. The overall behaviors of B-pillar and engine of simulation models agreed very well with the test data. The trends of accelerations at the driver and passenger head were similar but big differences in peak values. The differences of peak values caused the large errors of the HIC36 and 3 ms chest g's. To predict well the behaviors of dummies, the spring-mass model for the offset frontal crash needs to be improved.

**Keywords**—Chest g's, HIC36, lumped spring-mass model, offset frontal impact, SISAME.

## I. INTRODUCTION

OFFSET frontal impact testing has conducted worldwide as an assessment of the frontal crashworthiness of vehicles. The offset frontal crash test is now conducted in Europe (EuroNCAP), Australia (ANCAP), Japan (JNCAP) and Korea (KNCAP), etc. The offset frontal crash test has added to the KNCAP to complement the full frontal crash test since 2009 [1]. The full frontal crash test and the offset frontal crash test could complement each other; the full frontal crash test is especially demanding of restraints, while the offset frontal crash test is demanding of the structural integrity of a vehicle.

Crashworthiness evaluation is ascertained by a combination of tests and analytical methods. As the cost-effective alternatives to full-scale vehicle tests, finite element analysis (FEA) has been widely adopted in the vehicle development process. However, simulations using FEA are still time consuming and expensive because of requiring powerful hardware and software.

Mathematical model, with all its limitations, can provide quick assessment of various design concepts and explore new design directions [2]. Kamal developed the Lumped Mass-Spring (LMS) model consisted of three rigid masses and eight nonlinear springs for the analysis of vehicle frontal impact [3]. Pawlus et al. presented various research results related to the lumped parameter mathematical models using the vehicle to pole collision test results of Ford Fiesta 1987 model [4]. Lim proposed the LMS model to obtain the occupant's injury using the SISAME and the full-scale frontal crash test data from the National Highway Traffic Safety Administration (NHTSA) database [5]-[7].

For the offset frontal impact test, the car strikes the 40%

offset deformable barrier head-on at 56 kph in case of UN Regulation No. 94 or 64 kph in case of NCAP. The 40% offset is an overlap percentage of the car width with the deformable barrier. The offset frontal test forces a smaller portion of the vehicle's front end to manage crash energy, there is more localized deformation on the tested vehicle than seen in full frontal tests [11]. Therefore, the construction of LMS model for the offset frontal crash may be difficult than for the full frontal crash.

Carrera et al. developed the LMS model for the offset frontal impacts consisted of five masses and fourteen springs using the SISAME [8]. Cheva et al. developed LMS model for the offset frontal crash consisted of ten masses and twenty springs using nonlinear finite element analysis [9]. Han et al. developed the LMS model for the offset frontal impact analysis consisted of eleven masses and twenty three springs using the crushing characteristics of the tube-type members [10].

This study proposes the LMS modeling method on the offset frontal impact for obtaining the occupant's injuries as well as crash pulse. For this purpose, the SISAME software and full-scale offset frontal crash test data were used for the LMS model construction.

## II. SPRING-MASS MODEL CONSTRUCTION

The SISAME (Structural Impact Simulation And Model Extraction) is a general purpose tool for extracting and simulating one-dimensional nonlinear lumped parameter structural models [5]. The procedures to construct the simulation model using the SISAME comprised of two stages. In the first stage, the weights of the mass elements are extracted using accelerations and forces from the test data. In the second stage, the load-paths of spring elements are extracted using the weights of mass elements obtained from the first stage and the accelerations from the test data. The weights of mass elements and the load-paths of spring elements are optimally extracted that the motions of masses satisfy the accelerations and the forces of the test data.

The lumped spring-mass models developed in this study are represented in Figs. 1 and 2. The model configuration 1 represented in Fig. 1 is the developed model by the Carrera et al. and dummy parts are added in this study [6], [8]. The model configuration 2 presented in Fig. 2 is simplified model of the model configuration 1. The upper parts of dummies are considered to obtain the injuries of occupants.

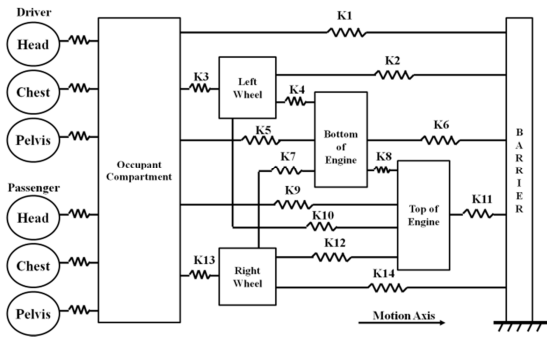

Fig. 1 Lumped spring-mass model configuration 1

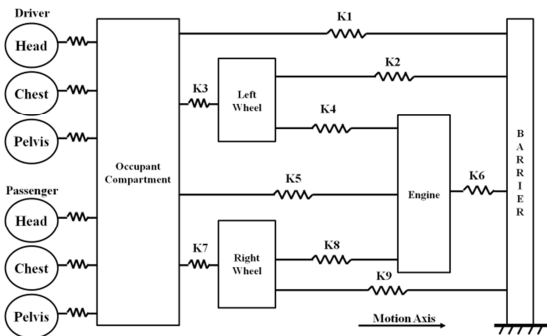

Fig. 2 Lumped spring-mass model configuration 2

III. DATA EXTRACTION

The data on 56 kph 40% offset frontal vehicle to deformable barrier crash test of a MY2007 Mazda 6 4-door sedan were obtained from NHTSA and used for the construction of the spring-mass models [7], [13]. The weight of tested vehicle was 1,599 kg. Barrier force and accelerations of Mazda 6 for constructing the spring-mass model are represented in Figs. 3~9. In the first stage, the extracted weights of mass elements are represented in Table I. The weights of mass elements except dummies were extracted in the first stage. The weights of dummy parts were obtained from HUMANETICS [12].

Barrier force represented in Fig. 3 was averaged from ninety load cells data. The accelerations of B-pillar represented in Fig. 4 were averaged and the averaged acceleration was used in the model extraction process of configuration 1 and configuration 2. The accelerations of Engine bottom and top represented in Fig. 5 were used for the model configuration 1. The averaged acceleration of Engine bottom and top was used for the model configuration 2. The cutoff frequencies of 60 Hz for the vehicle body parts, 1,000 Hz for the dummy head and 180 Hz for the dummy chest and pelvis were used for obtaining the reasonable results during the model extraction processes and the simulation runs.

TABLE I  
WEIGHTS OF MASS ELEMENTS

Model	Occ. Comp.	Wheel	Engine	Head	Chest	Pelvis
1	708.06 kg	23.0 kg	600/155.4kg	4.54 kg	17.19 kg	23.04 kg
2	649.96 kg	45.6 kg	768.3 kg	4.54 kg	17.19 kg	23.04 kg

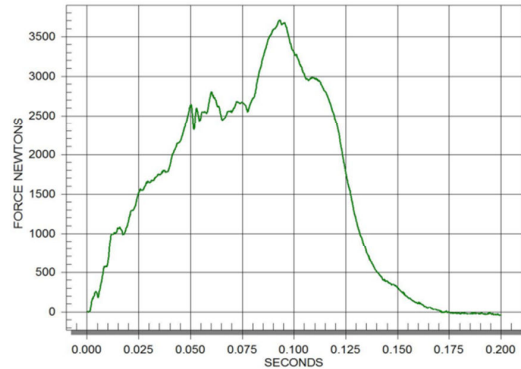

Fig. 3 Barrier force from load cells

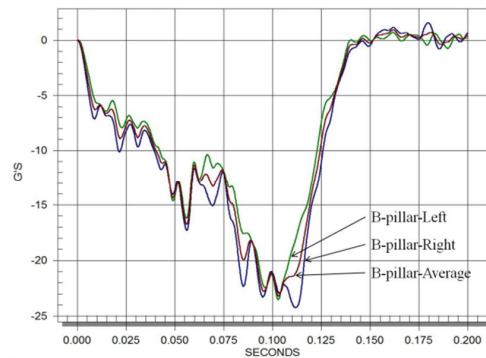

Fig. 4 Accelerations at the B-pillar L/R

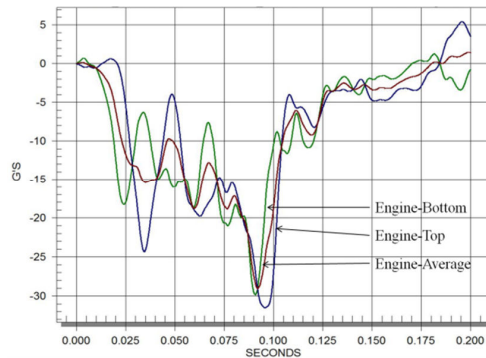

Fig. 5 Accelerations at the engine

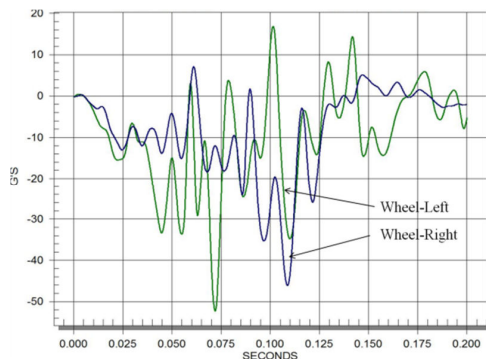

Fig. 6 Accelerations at the wheels L/R

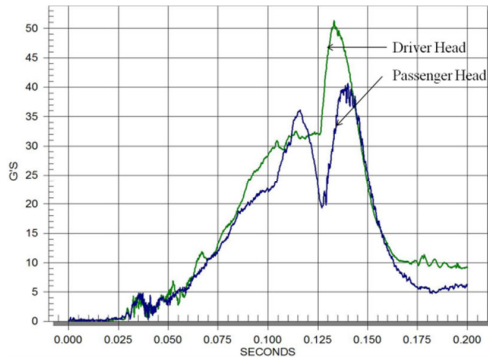

Fig. 7 Accelerations at the dummy head

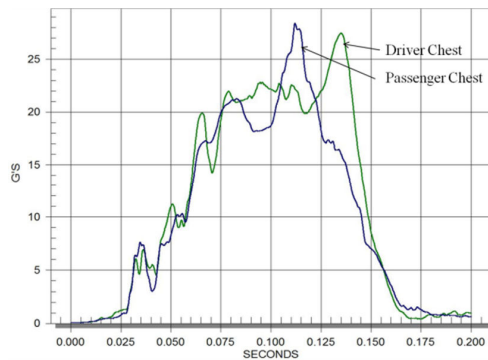

Fig. 8 Accelerations at the dummy chest

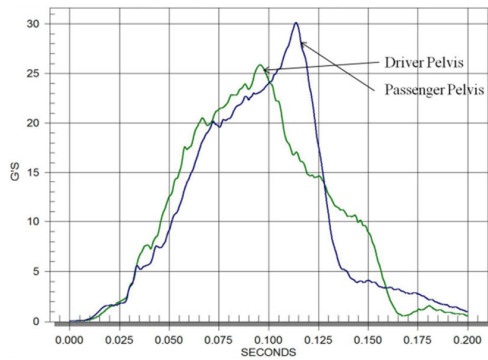

Fig. 9 Accelerations at the dummy pelvis

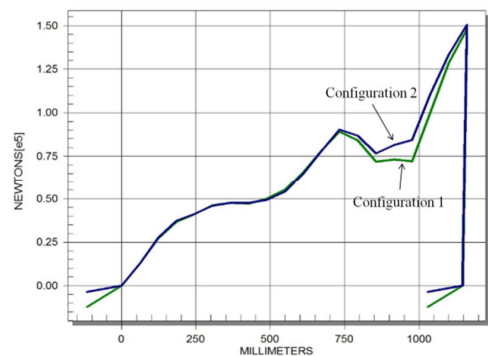

Fig. 10 Load-paths for spring K1

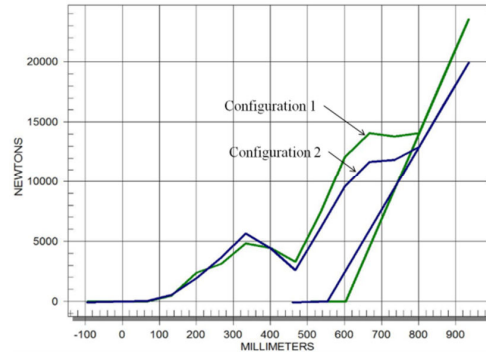

Fig. 11 Load-paths for spring K2

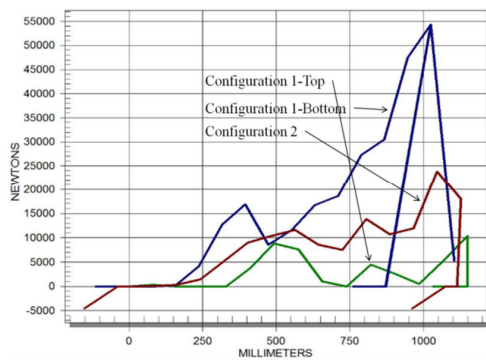

Fig. 12 Load-paths for K6/K11

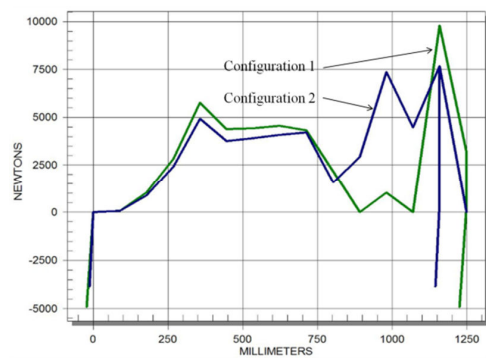

Fig. 13 Load-paths for K14/K9

In the second stage, some of the extracted load-paths of spring elements are represented in Figs. 10~13. Fig. 10 shows the load-paths of spring K1 which connects the barrier to the occupant compartment. Fig. 11 shows the load-paths through the left wheel. Fig. 12 shows the load-paths through the engine. Fig. 13 shows the load-paths through the right wheel.

#### IV. RESULTS AND DISCUSSIONS

To investigate the effectiveness of the spring-mass models for the offset frontal crash, the accelerations of body parts and dummy parts are compared with the test results represented in Figs. 14~23. The test data were truncated to 200 ms due to head contact with B-pillar at about 220 ms [13]. As shown in Fig. 14, the overall behaviors of simulations models agreed very well

with that of the test result. The accelerations of the model configuration 1 and configuration 2 were exactly agreed until 130 ms. As represented in Figs. 15~17, the accelerations at the engine agreed very well with test except the peak values. As represented in Figs. 18 and 19, the trends of accelerations of wheels were similar but big differences in peak values.

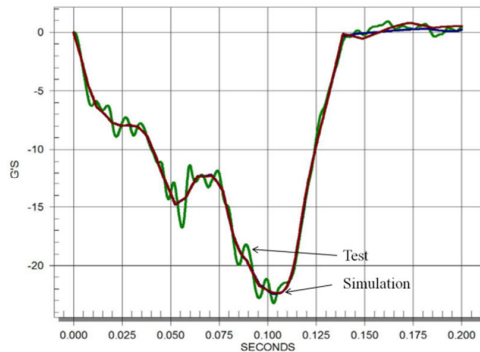

Fig. 14 Accelerations at B-pillar

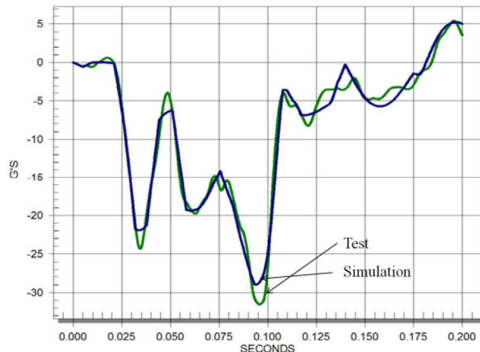

Fig. 15 Accelerations at the engine bottom (Configuration 1)

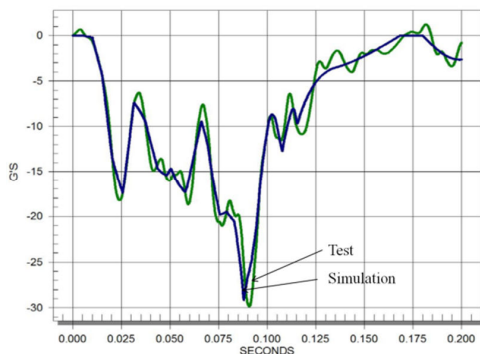

Fig. 16 Accelerations at the engine top (configuration 1)

There were no differences between the simulation results of dummy parts for the configuration 1 and configuration 2, as shown in Figs. 20~23. The behavior of dummy head of driver position at 135 ms is represented in Fig. 24.

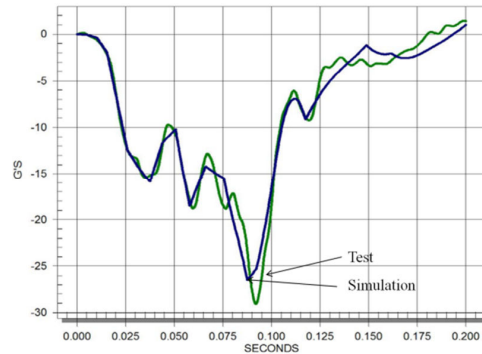

Fig. 17 Accelerations at the engine (Configuration 2)

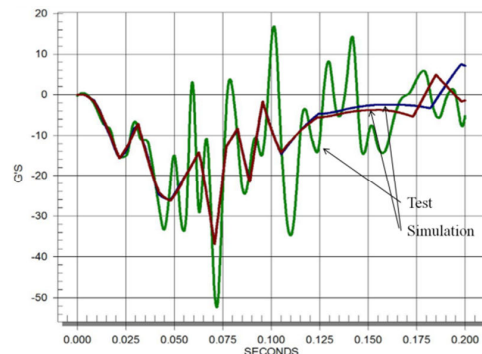

Fig. 18 Accelerations at the left wheel

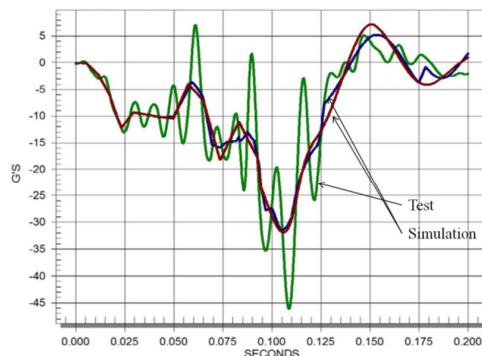

Fig. 19 Accelerations at the right wheel

The trends of accelerations at the driver and passenger head were similar but big differences in peak values, as shown in Figs. 20 and 21. As shown in Fig. 24, the dummy head is contacted to the left side of airbag. As the dummy head approached the steering wheel, the peak acceleration of dummy head at the driver seat suddenly increased around 135 ms. It may be very difficult to simulate this phenomenon using the one-dimensional spring-mass model. These differences in peak values could cause the simulation error for the HIC36.

The accelerations of driver and passenger chest were very similar to the test except peak value. The peak differences could cause the simulation error for the 3 ms chest g's.

The HIC36 and 3 ms chest g's are represented in Tables II and III. The errors of HIC36 for the passenger head and 3 ms chest g's for the driver chest were around 10%. The errors of

HIC36 for the driver head and 3 ms chest g's for the passenger chest are about 28% and 16% respectively due to the big differences of peak values.

Considering the model configuration 1 and 2, the results between model configurations were little difference. Although the separate of engine parts into bottom and top on the model configuration 1 increased the complexity of spring-mass model, the accuracies for the dummy behaviors did not improved. Compared to the model configuration 1, the model configuration 2 was simple but relatively effective.

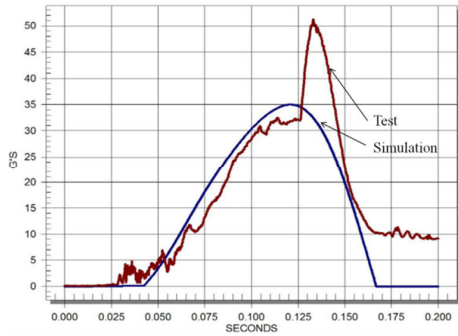

Fig. 20 Accelerations at the driver head

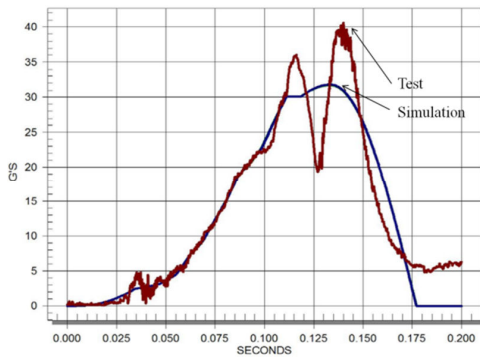

Fig. 21 Accelerations at the passenger head

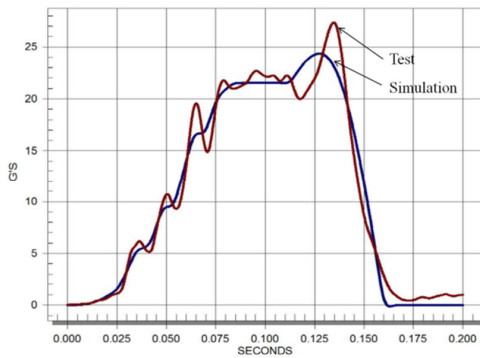

Fig. 22 Accelerations at the driver chest

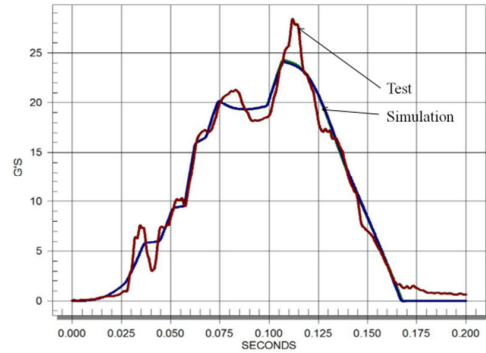

Fig. 23 Accelerations at the passenger chest

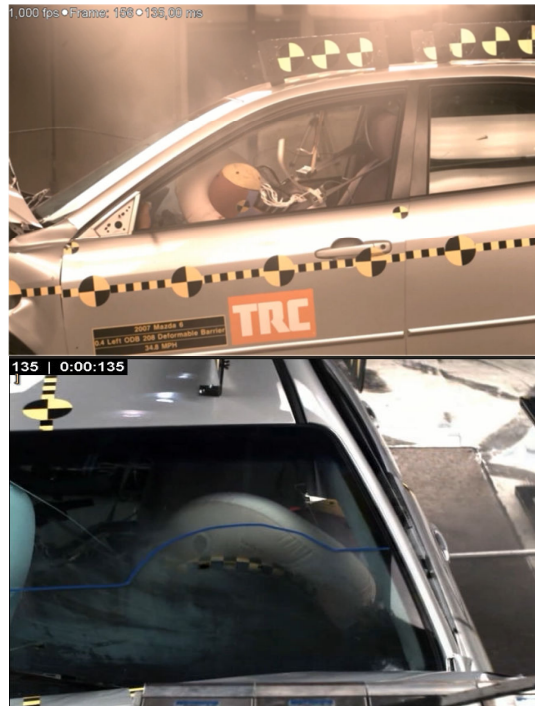

Fig. 24 Driver head behavior at 135 ms

TABLE II  
COMPARISON OF TEST AND SIMULATION RESULTS FOR THE HIC36

Model	Driver			Passenger		
	Test	Analysis	Err. (%)	Test	Analysis	Err. (%)
Model 1	323	234	27.6	209	189	10.6
Model 2		233	27.9		189	10.6

TABLE III  
COMPARISON OF TEST AND SIMULATION RESULTS FOR THE 3MS CHEST G'S

Model	Driver			Passenger		
	Test	Analysis	Err. (%)	Test	Analysis	Err. (%)
Model 1	27.0	24.4	9.6	27.8	24.2	12.9
Model 2		24.2	10.4		24.0	13.7

V. CONCLUSION

To construct the lumped spring-mass model considering the occupants for the offset frontal crash, the SISAME software and the NHTSA test data were used. The weights of mass elements and the load-paths of spring elements were directly

extracted from the test data. The behaviors of the body parts and dummy parts of the simulation models were very similar to the test results except peak values. The overall behaviors of B-pillar and engine of simulation models agreed very well with the test data. The differences of peak values caused the large errors of the HIC36 and 3 ms chest g's. It is still difficult to predict well the behaviors of dummies under the offset frontal crash scenario using the one-dimensional spring-mass model. To predict well the behaviors of dummies, the spring-mass model for the offset frontal crash needs to be improved.

## REFERENCES

- [1] J. M. Lim, D. J. Lee and G. H. Kim, "Frontal crash protection results considering the full frontal and offset frontal crash in KNCAP," in *Proc. FISITA World Automotive Congress 2010*, Paper No. F2010-D-046, Budapest, Hungary, May 30 - June 4, 2001.
- [2] P. Du Bois, C. C. Chou, B. B. Fileta, T. B. Khalil, A. I. King, H. F. Mahmood, H. J. Mertz and J. Wismans, *Vehicle Crashworthiness and Occupant Protection*. American Iron and Steel Institute, 2004.
- [3] M. M. Kamal, "Analysis and simulation of vehicle to barrier impact," *SAE Paper*, No. 700414, 1970.
- [4] W. Pawlus, H. R. Karimi and K. G. Robbersmyr, "Investigation of vehicle crash modeling technique," *Int. J. Adv Manufacturing Technology*, vol. 15, No. 6, pp. 965-993, 2014.
- [5] S. G. Mentzer, *The SISAME Program: Structural Crash Model Extraction and Simulation*, DOT HS Final Report, 2007.
- [6] J. M. Lim, "A lumped mass-spring model construction for crash analysis using full frontal impact test data," *Int. J. Automotive Technology*, submitted for publication, 2015.
- [7] NHTSA, *Vehicle Crash Test Database*, <http://www-nrd.nhtsa.dot.gov/database/veh/veh.htm>.
- [8] A. C. Carrera, S. G. Mentzer and R. R. Samanda, "Lumped-parameter modeling of frontal offset impacts," *SAE Paper*, No. 950651, 1995.
- [9] W. Cheva, T. Yasuki, V. Gupta and K. Mendis, "Vehicle development for frontal/offset crash using lumped parameter modeling," *SAE Paper*, No. 960437, 1996.
- [10] B. K. Han, H. Jung and J. H. Kim, "Developing the LMS model for frontal offset impact analysis," *Trans. of the KSAE*, Vol. 11, No. 1, pp. 211-216, 2003 (Korean).
- [11] J. M. Nolan and A. K. Lund, "Frontal offset deformable barrier crash testing and its effect on vehicle stiffness," in *Proc. The 17<sup>th</sup> International Technical Conference on the Enhanced Safety of Vehicles (ESV)*, Paper No. 487, Amsterdam, The Netherlands, June 4-7, 2001.
- [12] HUMANETICS, <http://www.humanetics.com/>.
- [13] W. D. Dudek, *Final Report of a 40% Frontal Offset Vehicle to Deformable Barrier Crash Test of a 2007 Mazda 6 4-door sedan*, NHTSA No. R75400, November 2006.