

Seismic Behavior of Three-Dimensional Steel Buildings with Post-Tensioned Connections

M. E. Soto-López, I. Gaxiola-Avendaño, A. Reyes-Salazar, E. Bojórquez, S. E. Ruiz

Abstract—The seismic responses of steel buildings with semi-rigid post-tensioned connections (PC) are estimated and compared with those of steel buildings with typical rigid (welded) connections (RC). The comparison is made in terms of global and local response parameters. The results indicate that the seismic responses in terms of interstory shears, roof displacements, axial load and bending moments are smaller for the buildings with PC connection. The difference is larger for global than for local parameters, which in turn varies from one column location to another. The reason for this improved behavior is that the buildings with PC dissipate more hysteretic energy than those with RC. In addition, unlike the case of buildings with WC, for the PC structures the hysteretic energy is mostly dissipated at the connections, which implies that structural damage in beams and columns is not significant. According to these results, steel buildings with PC are a viable option in high seismicity areas because of their smaller response and self-centering connection capacity as well as the fact that brittle failure is avoided.

Keywords—Inter-story drift, Nonlinear time-history analysis, Post-tensioned connections, Steel buildings.

I. INTRODUCTION

SEVERE damage to welded connections in steel buildings subject to cyclic loading occurred in the 1994 Northridge Earthquake. Since then, several alternative connections have been proposed to improve the behavior of steel buildings in high seismicity areas. Research on the seismic behavior of steel moment resisting frames (MRF) with semi-rigid post-tensioned connections (PC) has been recently developed [1]-[7]. They are structural elements which include energy dissipating elements and high strength strands, in addition to beam and columns. The structures with PC have the potential to minimize residual drifts and reduce structural damage under strong earthquakes. In addition, the PC has remarkable energy dissipation and self-centering (SC) capacity. After the action of a severe earthquake, the beams and columns can return to their original location. The PC also improves the behavior of steel buildings by reducing inter-story drifts, which is a widely used parameter to evaluate the performance of structures.

Early research about the study of PC structures were oriented to experimental tests of connections to calibrate design models and perform analysis of MRF which were

compared with analysis of steel MRF with rigid (welded) connections (RC) [1], [2]. In subsequently studies design parameters were evaluated and a design procedure was proposed [6], [7]. Recently, the behavior of steel frames with post-tensioned connections has been improved by adding friction devices in beams, which provides additional energy dissipation capacity [8], [9]. In another studies, it was concluded that the maximum and residual inter-story drifts in steel buildings with PC are lower than the corresponding drifts of buildings with RC [10]. The distribution of dissipated hysteretic energy through the height of regular steel frames with RC and PC was evaluated to propose simplified mathematical expressions which estimate distribution factors [11].

The general conclusions in most of the mentioned studies are that the responses of the frames with PC are smaller than those of the frames with RC, that the frames were able to undergo large inelastic deformations (drifts larger than 4%) with minimum damage in beams or columns and consequently minimum residual drift and strength degradation. In spite of the important contributions of these studies, most of them were limited to structural sub-assemblages or to plane models. In seismic design of steel buildings with perimeter MRF, it is common to model the three-dimensional (3D) structure as a plane structure. Modeling these buildings as plane (2D) frames may not represent the real behavior of the structure, since the participation of some elements is not considered and the contribution of some vibration modes is ignored. Besides, the properties in terms of stiffness, mass distribution, natural frequencies and energy dissipation characteristics for the 2D and 3D models of the buildings can be quite different. Moreover, results in terms of local response parameters, namely, axial load or bending moment at particular beam or beam-columns elements have not been considered. In this paper, the nonlinear seismic responses of steel buildings with PC are estimated and compared with those of corresponding steel buildings with typical welded (RC). The comparison is made in terms of global (interstory shears, interstory displacements, roof displacements) and local (axial loads and bending moments at some columns) response parameters, first for 3D representations of the buildings and then for 2D representations. Finally a comparison is made between the results of 3D and 2D models.

II. CONNECTION MODEL

The connection used in this research consists of two angles bolted to the beam and column flanges. The beams are post-tensioned to columns by using high strength steel strands

M. E. Soto-López, A. Reyes-Salazar and I. Gaxiola-Avendaño, Facultad de Ingeniería, Universidad Autónoma de Sinaloa, Calzada de la Américas y Boulevard Universitarios s/n, Ciudad Universitaria, Culiacán, Sinaloa, C.P. 80040 México (e-mail: nety_99@hotmail.com, reyes@uas.edu.mx, israelgaxiola@hotmail.com).

S. E. Ruiz, Instituto de Ingeniería, Universidad Nacional Autónoma de México, Coyoacán, C.P.04510, México, D.F. (e-mail: sruizg@iingen.unam.mx).

which are anchored to the exterior column flange (Fig. 1 (a)). The strands are designed to remain elastic under the action of the design seismic loads while the damage is confined to the bolted angles. Due to the fact that the angles are easy to replace, the structure can be easily restored at low costs after a strong earthquake. The angles and strands work as springs in parallel and the flexural strength of the connection is coming from the contribution of the high strength strands and that of the bolted angles

The Ruamoko Computer Program [12] is used in the study to estimate the seismic responses of some steel building models. The PC are represented by the flag-shaped bi-linear hysteresis model considered in the program. The flexural behavior of the PC is characterized by a gap opening and closing at the beam-column interface under cyclic loads. The moment at which the connection just starts opening is called decompression moment (M_d) and the moment in which the gap is closed is de closing moment (M_c).

A. The Richard Model

Fig 1 (b) shows a semi-rigid (SR) connection with top and seat angles. The SR connections properties can be represented by their moment-relative rotation curves ($M-\theta$). The relative rotation (θ) represents the angle change formed between the beam and column and M is the bending moment at the end of the beam. Several analytical expressions have been proposed to represent moment-relative rotation curves for SR connections. Some of these models are the piecewise linear, the polynomial, the exponential, the B-spline, and the Richard models. The Richard Model [13] is used in this study to represent the $M-\theta$ hysteresis rule of bolted angles.

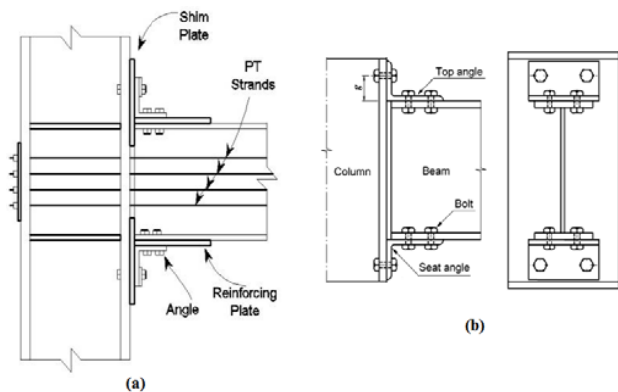

Fig. 1 (a) Semi-rigid PT connection and (b) Semi-rigid connection of top and seat angles

The Richard model is a four-parameter model which was developed using actual worldwide test data. A commercially available computer program, known as PRCONN, is available to generate the appropriate $M-\theta$ curve. According to the model, the $M-\theta$ curve is given by

$$M = \frac{(k-k_p)\theta}{\left(1 + \left|\frac{(k-k_p)\theta}{M_o}\right|^N\right)^{\frac{1}{N}}} + k_p\theta \quad (1)$$

where k is the initial or elastic stiffness, k_p is the plastic stiffness, M_o is the reference moment, and N is the curve shape parameter. These parameters are shown in Fig. 2.

B. Combined Model for Strands and Angles

A feasible way to model PC results from the combination of the flexural strength contribution individual of angles and strands. Experimental studies [5], [6] proposed equations to quantify the linear contributions of strands. In summary this contribution can be stated by the following expression

$$M_s = M_d + k_{s\theta}\theta \quad (2)$$

In (2), $k_{s\theta}$ is the contribution of the strands to the rotational stiffness of the connection M_d and θ were defined before. Equations (1) and (2) can be easily combined to represent the complete behavior of a semi-rigid PC.

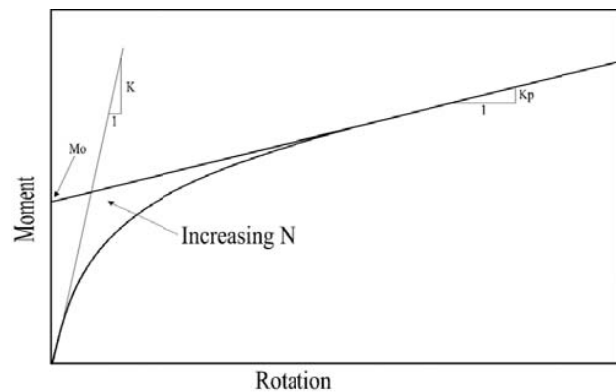

Fig. 2 Parameters of Richard model

III. STRUCTURAL MODELS

Several steel model buildings with MRFs were considered in the SAC steel project [14]. The models were designed by three consulting firms of United States according to the specifications of the following three cities codes: Los Angeles [15], Seattle [15] and Boston [16]. The 3- and 10-level buildings located in the Los Angeles area are considered in this study. They will be denoted hereafter as Models RC1 and RC2, respectively. The fundamental periods of Model RC1 are estimated to be 1.03, 0.99 and 0.07 sec., in the X (horizontal), Y (horizontal) and Z (vertical) directions, respectively. The corresponding values for Model RC2 are 2.22, 2.11 and 0.16 sec. The damping is considered to be 3% of the critical damping. The elevations of the models are given in Figs. 3 (a) and (d) and their plans in Figs. 3 (b) and (e). In these figures, the perimeter MRF are represented by continuous lines and the interior gravity frames (GF) by dashed lines.

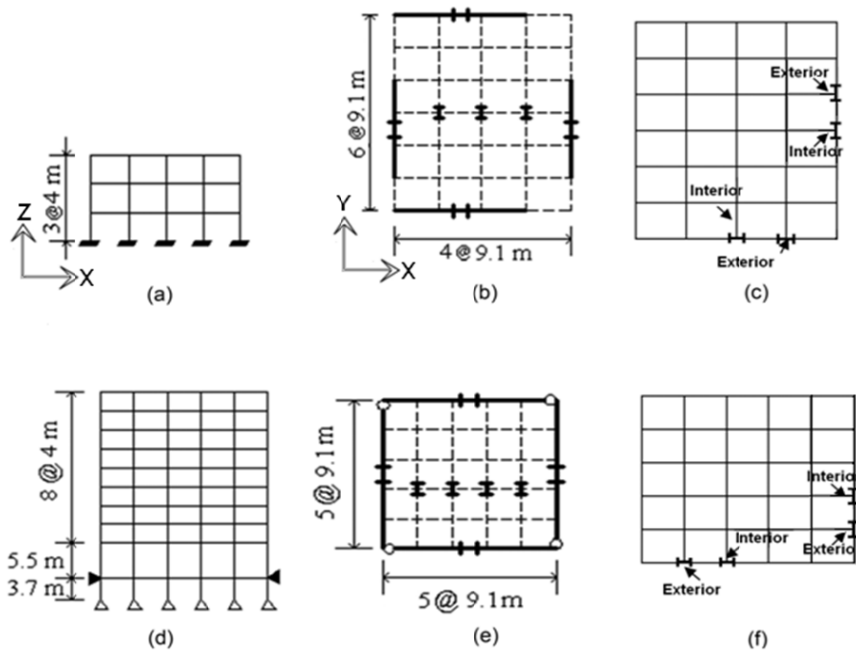

Fig. 3 (a) and (b) elevation and plan for Model RC1, (d) and (e) elevation and plan for Model RC2, (c) and (f) studied elements for Models RC1 and RC2

TABLE I
BEAM AND COLUMNS SECTIONS FOR MODELS 1 AND 2

Model	Story	Moment resisting frames			Gravity frames		
		Columns		Girders	Columns		Girders
		Exterior	Interior	Below	Penthouse	Others	
1	1\2	W14×257	W14×311	W33×118	W14×82	W14×68	W18×35
	2\3	W14×257	W14×311	W30×116	W14×82	W14×68	W18×35
	3\Roof	W14×257	W14×311	W24×68	W14×82	W14×68	W16×26
2	-1\1	W14×370	W14×500	W36×160	W14×211	W14×193	W21×44
	1\2	W14×370	W14×500	W36×160	W14×211	W14×193	W18×35
	2\3	W14×370	W14×500, W14×455	W36×160	W14×211, W14×159	W14×193, W14×145	W18×35
	3\4	W14×370	W14×455	W36×135	W14×159	W14×145	W18×35
	4\5	W14×370, W14×283	W14×455, W14×370	W36×135	W14×159, W14×120	W14×145, W14×109	W18×35
	5\6	W14×283	W14×370	W36×135	W14×120	W14×109	W18×35
	6\7	W14×283, W14×257	W14×370, W14×283	W36×135	W14×120, W14×90	W14×109, W14×82	W18×35
	7\8	W14×257	W14×283	W30×99	W14×90	W14×82	W18×35
	8\9	W14×257, W14×233	W14×283, W14×257	W27×84	W14×90, W14×61	W14×82, W14×48	W18×35
9\Roof	W14×233	W14×257	W24×68	W14×61	W14×48	W16×26	

Resultant forces are estimated for some particular columns, which are located at the ground floor level and are shown in Figs. 3 (c) and (f), for Models RC1 and RC2, respectively. The sizes of beams and columns are given in Table I for the two models. In all these frames, the columns are made of Grade-50 steel and the girders are of A36 steel. The design of the PC models starts with the design of the steel frames as usually is done (considering RC). Recommendations to design the frames with PC, which satisfy the requirements of the serviceability and resistance conditions, are proposed by [6]. According to these requirements, the properties of the bolted angles are proposed and their contribution to flexural strength

is calculated. Then, the properties and the number of strands as well as their contribution to flexural strength are estimated.

If the resulting PC has a hysteresis curve with low energy dissipation or problems with the closing moment another connection properties are tried. This procedure is repeated several times until reach the connection with the desired hysteresis curve.

TABLE II
EARTHQUAKE LOADINGS

No	Place	Date	Station	T (sec.)	ED (km)	M	PGA (cm/sec ²)
1	Landers, California	28/06/1992	Fun Valley, Reservoir 361	0.11	31	7.3	213
2	MammothLakes, California	27/05/1980	Convict Creek	0.16	11.9	6.3	316
3	Victoria	09/06/1980	Cerro Prieto	0.16	37	6.1	613
4	Parkfield, California	28/09/2004	Parkfield,JoaquinCanyon	0.17	14.8	6.0	609
5	PugetSound, Washington	29/04/1965	Olympia Hwy Test Lab	0.17	89	6.5	216
6	Long Beach, California	10/03/1933	UtilitiesBldg, Long Beach	0.20	29	6.3	219
7	Sierra El Mayor, Mexico	04/04/2010	El centro, California	0.21	77.3	7.2	544
8	Petrolia/Cape Mendocino, California	25/04/1992	Centerville Beach, Naval Facility	0.21	22	7.2	471
9	Morgan Hill	24/04/1984	GilroyArraySta #4	0.22	38	6.2	395
10	Western Washington	13/04/1949	Olympia Hwy Test Lab	0.22	39	7.1	295
11	San Fernando	09/02/1971	Castaic - Old Ridge Route	0.23	24	6.6	328
12	MammothLakes, California	25/05/1980	Long Valley Dam	0.24	12.7	6.5	418
13	El Centro	18/05/1940	El Centro - ImpVallIrrDist	0.27	12	7.0	350
14	Loma Prieta, California	18/10/1989	Palo Alto	0.29	47	6.9	378
15	Santa Barbara, California	13/08/1978	UCSB Goleta FF	0.36	14	5.1	361
16	Coalinga, California	02/05/1983	ParkfieldFaultZone 14	0.39	38	6.2	269
17	Imperial Valley, California	15/10/1979	Chihuahua	0.40	19	6.5	262
18	Northridge, California	17/01/1994	Canoga Park, Santa Susana	0.60	15.8	6.7	602
19	Offshore Northern, California	10/01/2010	Ferndale, California	0.61	42.9	6.5	431
20	Joshua Tree, California	23/04/1992	Indio, Jackson Road	0.62	25.6	6.1	400

IV. EARTHQUAKE LOADINGS

The structural models previously described were excited by twenty earthquake records with different frequency contents recorded around Los Angeles area. The characteristics of these earthquake time histories are given in Table II. Their predominant periods, vary from 0.11 to 0.62 sec. The earthquake time histories were obtained from the Data Sets of the National Strong Motion Program (NSMP) of the United States Geological Surveys (USGS). Additional information on these earthquakes can be obtained from this source. The earthquakes are scaled in such a way that the models undergo a similar level of deformation for each of the earthquakes. The drifts (interstory displacements) are used for this purpose. Values of 1%, 2%, and 3% were considered. For drift values of 1% moderate yielding occurred in most of the cases, but for values of 2% and 3% significant yielding occurred in many cases

V. METHODOLOGY

As previously mentioned, the responses of traditional welded and post-tensioned three-dimensional buildings are estimated and compared in this paper. The structural models were excited by twenty earthquake records. The responses are estimated using incremental nonlinear dynamic analysis. The RUAUMOKO program [12] was used for this purpose. The results are expressed in terms of interstory drifts, roof displacements, interstory shears and axial forces and bending moments in some particular members. The comparison is made for target deformation levels of the models in terms of drifts of 1%, 2% and 3%.

VI. RESULTS IN TERMS OF GLOBAL RESPONSE PARAMETERS

The seismic responses, in terms of global response parameters, for the 3D representation of the steel building models with RC are estimated and compared with those of the corresponding buildings with PC. Results in terms of interstory shears, for both, *N-S* and *E-W* directions, are presented first. The ratio given by the expression is used for this purpose.

$$V = \frac{V_{RC}}{V_{PC}} \quad (3)$$

V_{RC} and V_{PC} represent the interstory shear for the steel buildings with welded and post-tensioned connections, respectively. Results for V are presented in Fig. 4 for the 3-level model, *N-S* directions and drifts of 1%, 2% and 3%. The corresponding results for the 9-level model are given in Fig. 5. In this figures, the word "ST" stands for the story level. It can be observed that the V values significantly vary from one earthquake to another without showing any trend, even though the models were deformed to a similar level of deformation. It reflects the effect of the earthquake frequency contents and the contribution of several modes on the structural responses. The most important observation that can be made is that the values of V are larger than unity indicating that the interstory shears are larger for the models with RC, values of up to 1.5 are observed in some cases for the 3-level building. The values of V are significantly larger for the 9-level building, values of up to 1.8 are observed. The reason for this is that more hysteretic energy is dissipated in the buildings with PC. Moreover, the energy dissipated in beam and columns is negligible, implying minimum structural damage.

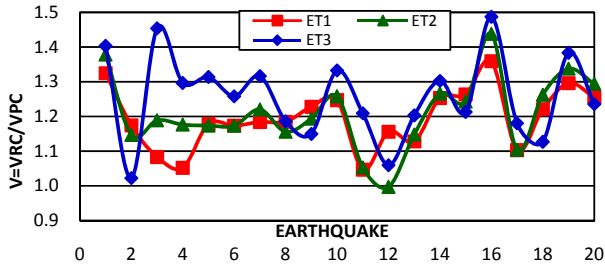

(a)

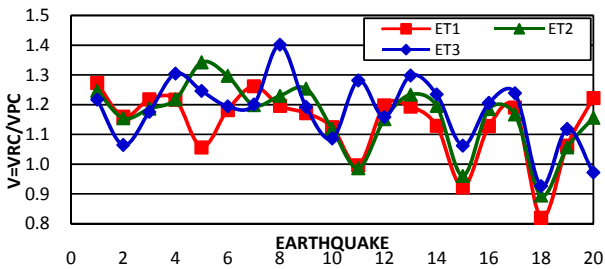

(b)

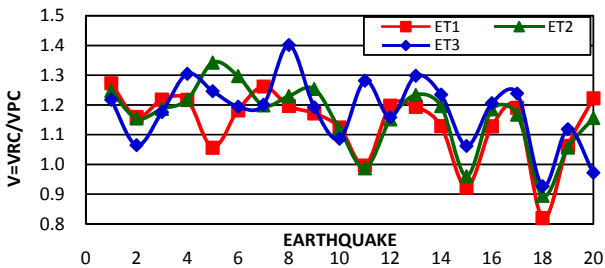

(c)

Fig. 4 Values of the V parameter, 3-level model, N-S direction (a) 1%, (b) 2%, and (c) 3%

Results for the E-W direction were also estimated but are not shown. For a given model, no significant differences are observed between the results of the N-S and the E-W directions.

Similar ratios to those of interstory shears are also calculated for interstory displacements. Most of the observations made for interstory shears are also valid for interstory displacements: the ratio values significantly vary from one earthquake to another without showing any trend, the values are larger than unity indicating that the interstory displacements are larger for the models with RC and the values are significantly larger for the 9-level than for the 3-level building. For a given model the magnitude of the ratios are quite similar for interstory shears and displacements.

The roof displacements for the models with RC and PC are now estimated. The displacement ratio given by

$$D = \frac{D_{RC}}{D_{PC}} \quad (4)$$

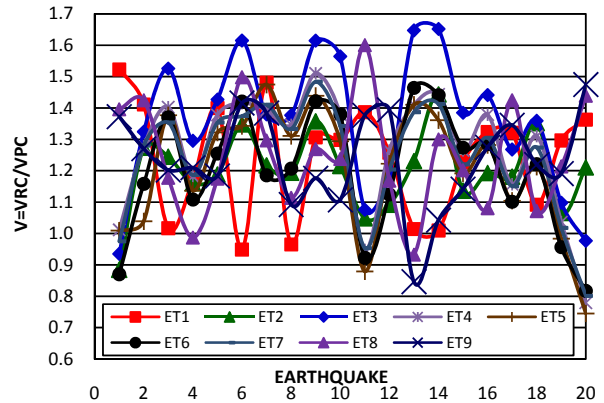

(a)

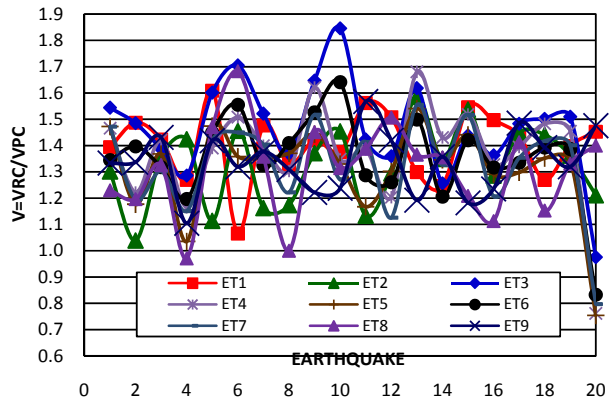

(b)

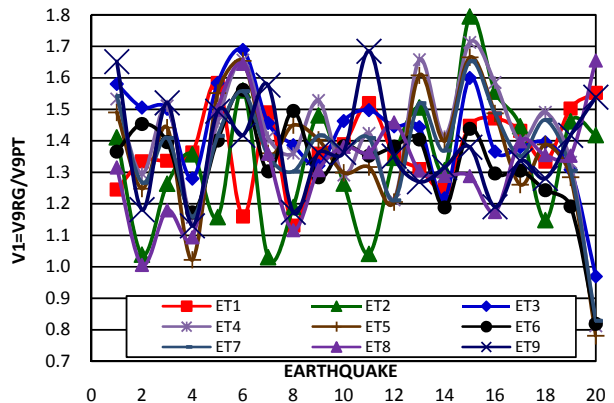

(c)

Fig. 5 Values of the V parameter, 9-level model, N-S direction (a) 1%, (b) 2%, and (c) 3%

is used to make the comparison, where D_{RC} and D_{PC} represent the same as before, except that now roof displacements are used instead.

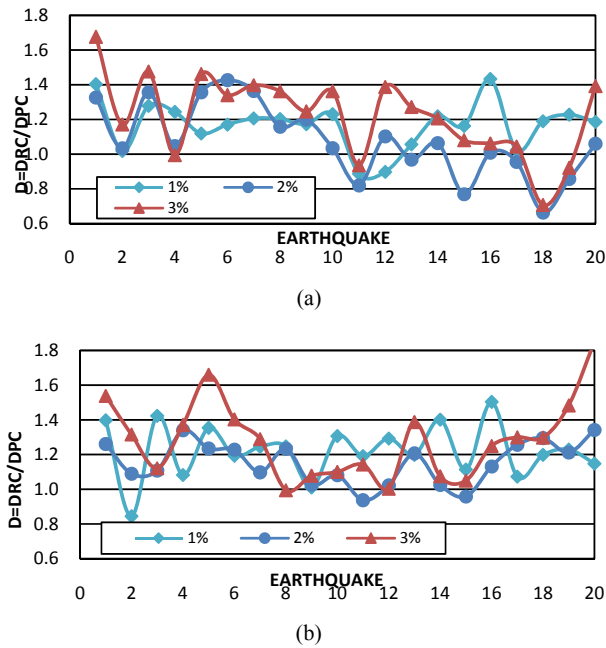

Fig. 6 Values of the D parameter, 3-level model, (a) N-S, (b) E-W

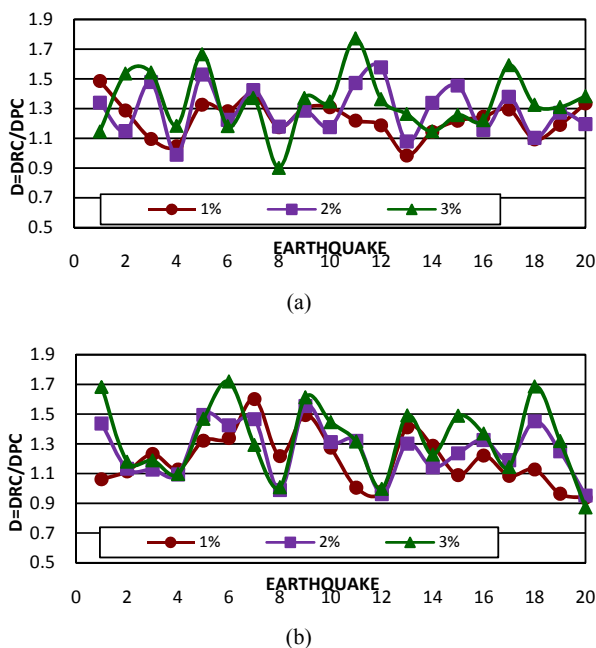

Fig. 7 Values of the D parameter, 9-level model, (a) N-S, (b) E-W

The results are given in Fig. 6 for the 3-level model, the N-S and E-W directions and drifts of 1%, 2% and 3%. The corresponding results for the 9-level model are given in Fig. 7. As for the case of shear, it is observed that the D values significantly vary from one earthquake to another, that they are similar for the N-S and E-W directions, that the values are larger than unity indicating larger roof displacements for the frames with WC, and that values are larger for the 9-level model. The only additional observation that can be made is

that D , in general, tend to increase as the target drift displacement increases.

VII. RESULTS IN TERMS OF LOCAL RESPONSE PARAMETERS

Similar ratios to those of interstory shear and roof displacements are also calculated for local response parameters for the case of axial loads and bending moments (A and M) at some columns of the base. The results for Axial loads are presented in Figs. 8 and 9 for the 3- and the 9-level buildings, respectively. The results are similar in one sense to those of global response parameters but different in another: the values of A significantly vary from one earthquake to another and are larger than unity in most of the cases. However, they are smaller for local response parameters. For a given model and amount of damping the A parameter significantly vary from one column location to another without showing any trend. The interstory shears and displacements, roof displacement, axial load and bending moment ratios, were also estimated for the 2D structural representation of the buildings but are not shown. Results indicate that the values of these ratios, in general, are larger for the 3D models.

VIII. CONCLUSIONS

The seismic responses of steel buildings with semi-rigid post-tensioned connections (PC) are estimated and compared with those of steel buildings with typical welded (rigid) connections (RC). Two steel buildings with perimeter moment resisting frames, which were used in the SAC steel project, and twenty strong motions are considered in the study. The comparison is made in terms of global (interstory shears and interstory and roof displacements) and local (axial loads and bending moments) response parameters. The results indicate that the seismic response in terms of interstory shears, roof displacements, axial load and bending moments are smaller for the buildings with PC connection. The difference is larger for global than for local response parameter, which in turn varies from one column location to another. The reason for this improved behavior is that the buildings with PC dissipate more hysteretic energy than those with RC. In addition, unlike the case of buildings with RC, the hysteretic energy is mostly dissipated at the PC which implies that structural damage in beams and columns is not significant. According to this results, steel buildings with PC are a viable option in high seismicity areas because of their smaller response and self-centering connection capacity, and also due to the fact that brittle failure is avoided.

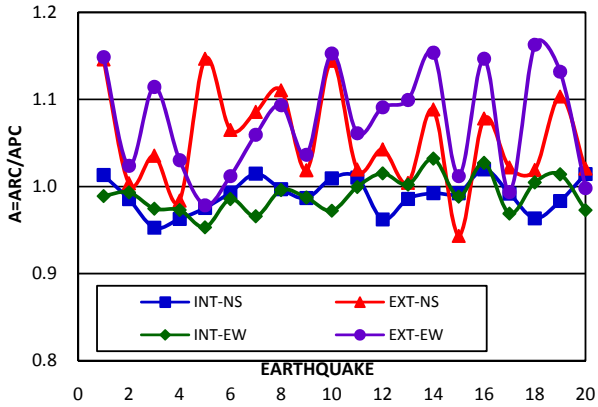

(a)

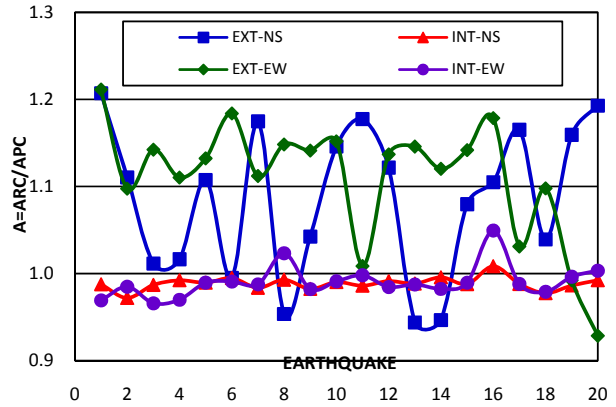

(a)

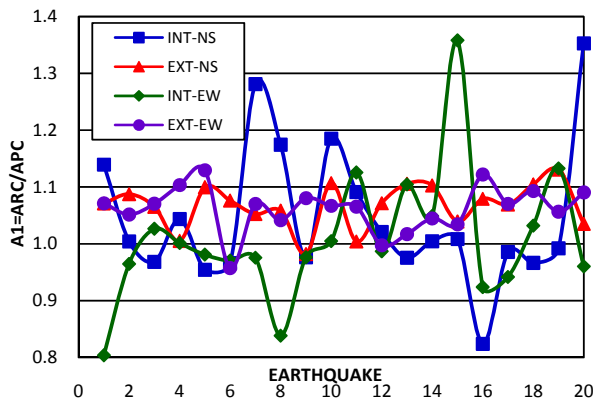

(b)

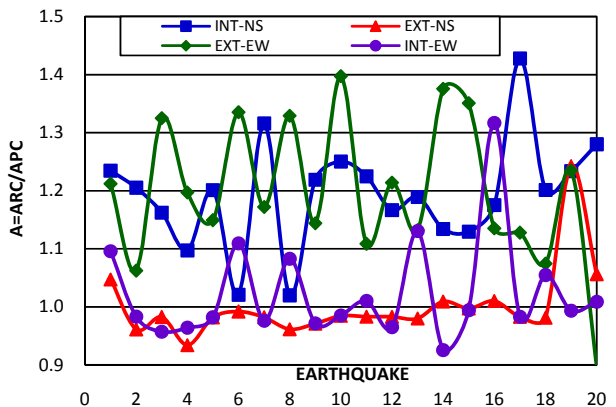

(b)

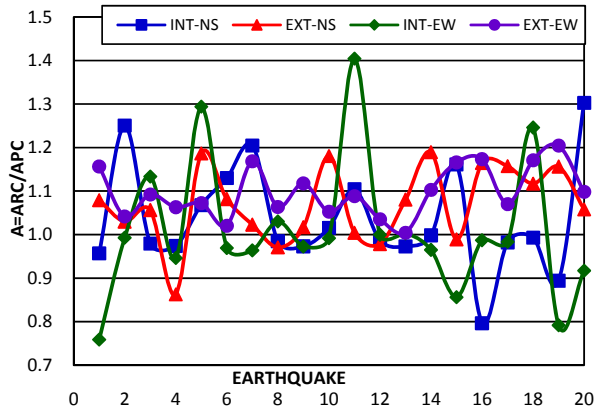

(c)

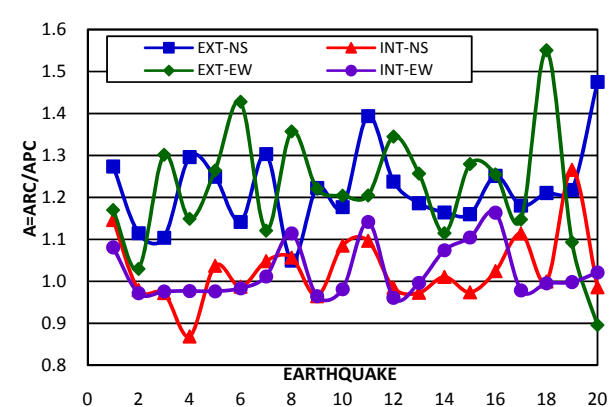

(c)

Fig. 8 Values of the A parameter, 3-level model, (a) 1%, (b) 2%, (c) 3%

Fig. 9 Values of the A parameter, 9-level model, (a) 1%, (b) 2%, (c) 3%

REFERENCES

- [1] Ricles, J.M., Sause, R., Garlock, M.M. and Zhao, C. 2001. Post-tensioned seismic-resistant connections for steel frames, *ASCE Journal of Structural Engineering*, Vol. 127, No. 2, p. 113-121.
- [2] Ricles, J.M., Sause, R., Peng, S.W. and Lu, L.W. 2002. Experimental evaluation of earthquake resistant post-tensioned steel connections, *ASCE Journal of Structural Engineering*, Vol. 128, No. 7, p. 850-859.

- [3] Christopoulos, C., Filiatrault, A. &Uang, C.M. 2002a. Self-centering post-tensioned energy dissipating (PTED) steel frames for seismic regions, *University of California*, Report No. SSRP-2002/06.
- [4] Christopoulos, C. &Filiatrault, A.. 2002b. Seismic response of post-tensioned energy dissipating moment resisting steel frames, *Proceedings of the 12th European Conference on Earthquake Engineering*, London, UK, paper No. 61.
- [5] Garlock, M, Ricles, J., &Sause, R. 2005. Experimental studies on full-scale post-tensioned steel connections. *Journal of Structural Engineering*, ASCE, v 131, n 3, p438-448.
- [6] Garlock, M, Sause, R. &Ricles, J. 2007. Behavior and design of post-tensioned steel frames system. *Journal of Structural Engineering*, ASCE v 133, n 3, p 389.
- [7] Garlock, M, Sause, R. &Ricles, J. 2008. Influence of design parameter on seismic response of post-tensioned steel MRF systems. *Engineering Structures*, Vol. 30, pp.1037-1047.
- [8] Ricles, J.M., Sause, R., Lin, Y.-C. andSeo, C.-Y. (2010). "Self-Centering Moment Connections for Damage-Free Seismic Response of Steel MRFs", *2010 Structures Congress*, p. 955-966.
- [9] Rojas, P., Suárez, D.C., Ricles, J.M. and Sause, R. (2012). "Seismic evaluation of an eight story building with self-centering steel moment resisting frames and flange friction devices", *15WCEE Lisboa 2012*.
- [10] López-Barraza, A., Ruiz, S. E., Bojórquez, E. & Reyes-Salazar, A. (2012a). "Seismic performance of steel frames with post-tensioned connections", *15WCEE Lisboa 2012*.
- [11] López-Barraza, A., Ruiz, S. E., Bojórquez, E. & Reyes-Salazar, A. (2012b). "Seismic energy demands on steel framed structures with rigid and, alternatively, with post-tensioned semi-rigid connections", *Stessa 2012*.
- [12] Carr A. RUAUMOKO (2011), *Inelastic Dynamic Analysis Program*, University of Cantenbury, Department of Civil Engineering
- [13] Richard, R.M. (1993), "Moment-rotation curves for partially restrained connections", PRCONN, RMR Design Group, Tucson, Arizona.
- [14] FEMA 350 (2000), *Federal Emergency Management Agency*, Report 350 "Recommended seismic design criteria for new steel moment-frame buildings", Washington, D.C.
- [15] UBC (1994), *Structural Engineering Design Provisions, Uniform Building Code, Volume 2, International Conference of Building Officials*.
- [16] BOCA (1993), *12th Edition Building Officials & Code Administration International Inc., National Building Code*.