

Dynamics Characterizations of Dielectric Electro-Active Polymer Pull Actuator for Vibration Control

A. M. Wahab, E. Rustighi

Abstract—Elastomeric dielectric material has recently become a new alternative for actuator technology. The characteristics of dielectric elastomers placed between two electrodes to withstand large strain when electrodes are charged has attracted the attention of many researcher to study this material for actuator technology. Thus, in the past few years Danfoss Ventures A/S has established their own dielectric electro-active polymer (DEAP), which was called PolyPower.

The main objective of this work was to investigate the dynamic characteristics for vibration control of a PolyPower actuator folded in 'pull' configuration. A range of experiments was carried out on the folded actuator including passive (without electrical load) and active (with electrical load) testing. For both categories static and dynamic testing have been done to determine the behavior of folded DEAP actuator.

Voltage-Strain experiments show that the DEAP folded actuator is a non-linear system. It is also shown that the voltage supplied has no effect on the natural frequency. Finally, varying AC voltage with different amplitude and frequency shows the parameters that influence the performance of DEAP folded actuator. As a result, the actuator performance dominated by the frequency dependence of the elastic response and was less influenced by dielectric properties.

Keywords—Dielectric Electro-active Polymer, Pull Actuator, Static, Dynamic, Electromechanical.

I. INTRODUCTION

A material that has human muscle characteristics potentially could provide an effective alternative to conventional actuator technology. Energy density, strain, actuation pressure, response time and efficiency are the important elements of an actuator material that need to be considered. In addition, the environmental tolerance, fabrication complexity, and reliability also need to be considered [1]. Thus, rapid developments and researches of so called artificial muscle led to the design of electro active polymers (EAPs). These materials can undergo large deformation, respond quickly and have high energy density hence they are also called artificial muscles [2]. Other attributes of dielectric elastomer include fast response, no noise, lightweight and low cost [3].

The ability of dielectric electro active polymers (DEAP) to

deform by applying voltage is similar to the deformation shown by any dielectric material subjected to electric field. However, the corresponding deformation is markedly enhanced by the softness of polymer itself, as well as compliance of the electrodes. These two key-features distinguish actuating devices made of dielectric elastomer from those based on different electric-field-driven electrics, such as piezoelectric and electrostrictive materials [4]. Ronald and Kornbluh suggested that, the dielectric elastomer shows the promising potential for being used not only as actuator but as well as sensor and generator, or it may be used to replace existing impractical technologies [5].

The unique features of DEAP, led Danfoss Ventures A/S to develop their own DEAP called PolyPower. PolyPower has improved actuator efficiency by solve the problem of previous DEAP, which elongated in two directions. A corrugated profile and metallic electrodes have been applied to enable the PolyPower to actuate in one direction only. The details specification of DEAP PolyPower actuator has been explained by [6]. PolyPower actuators are designed to act in a push or pull configuration. Previous studies focused on push actuators [7]. PolyPower folded pull actuator uses similar material as their previous push actuators. There are no changes in the material properties such as dielectric constant and elastic modulus. However, with different geometry it can lead to different actuator performance.

The purpose of the present study is to investigate the dynamic characteristics of folded PolyPower pull actuator. Experimental works have been done to determine the mechanical properties as well as electromechanical characteristics. The experiments reveal the nonlinearity in the folded PolyPower pull actuator and the parameters that dominate its performance.

II. PULL ACTUATOR

The DEAP material in a push actuator configuration is generally under compression when it is not actuated. Actuator produces force to lift the mass or load by pushing up. In the pull configuration the DEAP material is generally under extension. The actuator is stretched down as mass or force is hanging. The force produced by the actuator lifts up the mass by pulling up.

Fig. 1 shows a single degree of freedom model of the DEAP actuator to illustrate the differences between push and pull DEAP actuators. The ideal spring has an equilibrium length. At equilibrium, in Fig. 1 (a) spring is compressed. On the

Wahab, A.M. is with the Intelligent Dynamic System i-Khoza, Japan International Institute of Technology (MJIT), Universiti Teknologi Malaysia Kuala Lumpur, Jalan Semarak, 54100 Kuala Lumpur, Malaysia (phone: +60 0322031487; e-mail: abdulmalekabdulwahab@gmail.com).

Rustighi, E. is with the Institute of Sound and Vibration, Faculty of Engineering and the Environment, University of Southampton, SO171BJ, Southampton, United Kingdom (e-mail: er@isvr.soton.ac.uk).

other hand, the spring in Fig. 1 (b) is stretched. According to Hooke's Law, the force (F) exerted by a spring on objects attached to its ends is proportional to the spring's change in length (x) away from its equilibrium length and is always directed towards its equilibrium position, $F = -kx$. The negative sign shows that the force of the spring exerts on the object is in a direction opposite to the displacement of the free end and k represents the stiffness of the spring. Hooke's Law equation shows that the condition of material in either compression or extension does not affect the force/displacement relationship. The displacement and force produced by the material only depends on the stiffness of material

Fig. 2 shows the DEAP PolyPower pull actuator. The DEAP sheet is folded to form a flat structure.

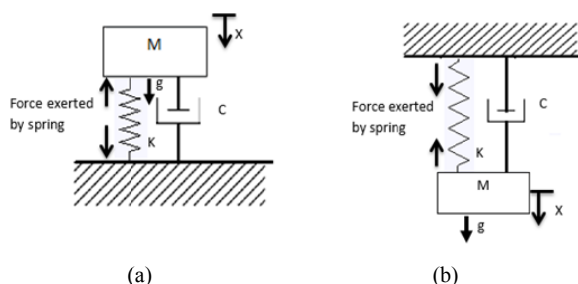

Fig. 1 Mass, spring and damper for (a) compression (push actuator) (b) stretching (pull actuator)

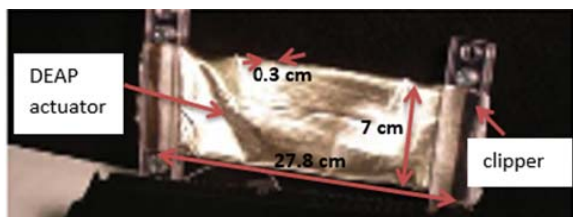

Fig. 2 Geometry of flat DEAP PolyPower pull actuator

III. MECHANICAL CHARACTERIZATION EXPERIMENT

Mechanical experiments include static and dynamic testing. Static experiment determines the stiffness of flat DEAP Polypower pull actuator. While dynamics testing determines natural frequency and loss factor of flat DEAP PolyPower pull actuator. All the mechanical characteristic experiment has been conducted in ISVR Dynamic Group while electromechanical characteristic experiment have been conducted in Tony Davies High Voltage lab (TDHV) University of Southampton since involving a high voltage amplifier.

A. Static Force-Displacement

The experiment relating stretching and force has been conducted to show the stiffness of the actuator. A test bench for determining relationship between forces and stretching displacement on flat DEAP Polypower pull actuator has been built as diagram in Fig. 3. In this experiment flat DEAP pull actuator with code number 1098 was used. The width of

actuator is 7 cm and the length is 27.8 cm. The thickness of actuator is around 0.3 cm. On the other hand the total weight of actuator is 274.5g where the weight of each clipper approximately 105g. The measurement is recorded at normal condition without any force applied. The measurement cannot be done during flat DEAP PolyPower pull actuator in hanging condition because the weight of clipper stretches the actuator and different measurement will occur. Fig. 2 shows the details of flat DEAP pull actuator.

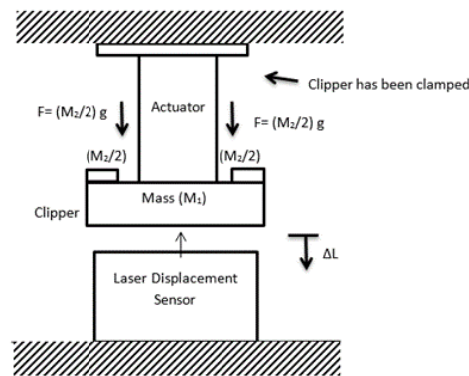

Fig. 3 Force-Displacement set up for flat DEAP pull actuator

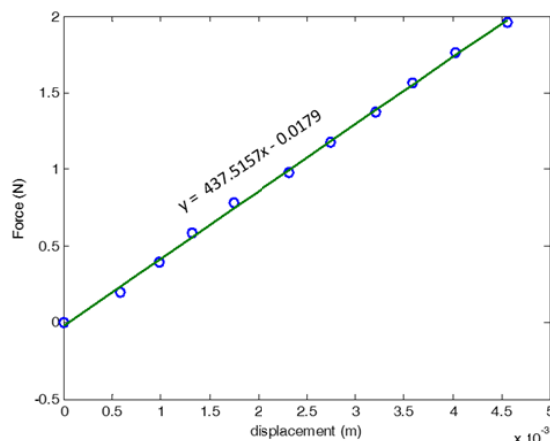

Fig. 4 Force-Displacement relationship 'o' are the data collected and straight line is interpolating of data. The gradient of the straight line represent the stiffness of the actuator, $\Delta F/\Delta d=k$

Fig. 3 shows the flat DEAP pull actuator hanged (rigidly fixed) at one end and free at the other end. The flat DEAP PolyPower pull actuator is fixed rigidly by clamping the clipper attached to actuator to static iron beam with G clamp. M is the mass of clipper attached to actuator. The equilibrium state is at pre stretch of actuator due to the mass of the clipper, M₁. In this experiment, gravitational force (F= mg) has been used as external force. The external forces have been applied by attaching mass M₂ at the clipper of actuator and gradually increasing in step 20g from 0g to 200g. A Kenya Laser displacement meter was used to record the stretch displacement of flat DEAP pull actuator due to external force, F (refer appendix A for details of laser displacement meter). It has been located around 3cm to 4cm under the actuator. This

range of distance was set up to ensure laser displacement meter working properly. During the experiment, the stretch displacements of flat DEAP PolyPower pull actuator subject to external force were recorded. Graph Force-Displacement was plotted from displacement and external force data recorded as shown in Fig. 4.

As a result, Fig. 4 shows the stretch displacement of actuator is proportional to force applied. The Hooke model is properly fit for the entire curve. Hooke model is linear, predicting that the force F is proportional to the change in length, ΔL . The mathematical representation of this behavior is

$$F = k(L - L_0) = k\Delta L \quad L > L_0 \quad (1)$$

k is the stiffness of the material, L_0 is the original length of actuator and L is the length of actuator due to external force. The stiffness of flat DEAP PolyPower pull actuator is determined by interpolating all the force-displacement data. Fig 4 shows the interpolation data produce linear relation, $y = 437.5157 x + 0.0179$. Since the value of y at x equal to zero is small, this value can be neglected which produced $y = 437.5157 x$. Assuming y equal to external force (F) and x is stretch displacement (L), the gradient of the equation is the stiffness (k) value of flat DEAP pull actuator, 437.5157 N/m. This condition is in line with [8] who indicated that DEAP actuator fit Hooke model at 10% of strain. Then the combination result of Young Modulus, E and crossing area due to external force, A_i of flat DEAP pull actuator can be estimated by,

$$EA_i = \frac{F}{\Delta L} L_i \quad (2)$$

L_i is the total displacement subjected to force applied. The relation between EA_i and L_i is plotted as in Fig. 5.

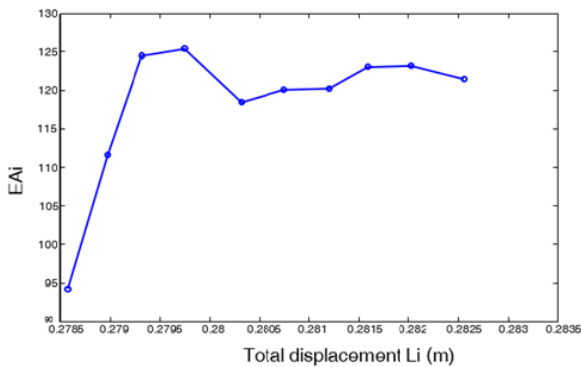

Fig. 5 Plotting of EA versus total length L_i

The EA of flat DEAP PolyPower pull actuator is rapidly increasing at the beginning of elongation. Perhaps, this is because increasing elongation all the sheets are gradually engaged. However, according to [6], the composite material initially has inherent constraints that have to be eliminated before force characteristic are observed in actuator. After this

initial increase, EA start decreasing. According to [8], the volume of the DEAP actuator is constant during deformation. In order for volume remains constant increasing in length means a decrease in A . Therefore, it can be concluded that the thickness of flat DEAP PolyPower pull actuator decreases in order for volume remain constant during deformation.

B. Dynamic Testing

In order to determine the natural frequency and loss factor of flat DEAP PolyPower pull actuator, dynamic testing has been conducted. The actuator was excited and Frequency Response Function (FRF) was plotted. In this testing accelerance has been measured in term of FRF. Fig. 6 shows the diagram and the setting of equipment for the experiment. One end of flat DEAP pull actuator was clamped and another end was hung freely. The accelerometer was positioned directly on the structure, attached at the clipper of the actuator. At the same time, the force transducer was at the end of the stinger, in contact with the clipper actuator. In this way only the exciting force was measured. Electro-magnetic shaker was used to excite the actuator. The electromechanical shaker used in the tests was able to act in only one direction, so that the modal response in just that direction could be obtained. Stinger was used to attach shaker and actuator.

The signal used to drive the shaker in the tests was set to pseudo-random. The transfer function of accelerance has been recorded by spectrum analyzer for 30s, rectangular windowed, with a frequency resolution of 3200 lines and over an average of 75 times.

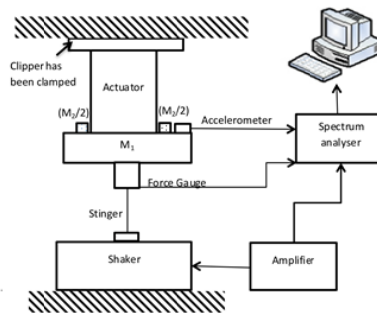

Fig. 6 Dynamic testing for DEAP Polypower pull actuator

The accelerance of actuator at mass M was plotted and indicated, as accelerance at M . Mass M is the mass of clipper. The pre stretch condition of flat DEAP pull actuator due to mass M was assumed as equilibrium condition. Then the effect of mass has been investigated by attaching mass M_2 at actuator in step of 20 g up to 200 g.

Figs. 7 (a) and (b) show the accelerance graph and corresponding phase angle of pull actuator for additional mass M_2 respectively. It can be seen that the accelerance graph has one peak (resonance) around 13Hz for mass M only and decreasing as mass M_2 is added. In addition, Fig. 7 (c) shows the relationship between total mass m_{total} and natural frequency. The decreasing of natural frequency value is expected since resonance frequency is inversely proportional with mass. This behaviour shows by:

$$f = 2\pi \sqrt{\frac{k}{m_{total}}} \quad (3)$$

f is natural frequency, k is stiffness and m_{total} is additional of M and M_2 of the system. Resonance frequency (natural frequency) of actuator depends on m_{total} attached and its stiffness. Resonance frequency is important in many applications since it dictates the bandwidth (the range of operation frequency) of actuator in successfully attenuates vibration.

dissipate energy. When these materials are deformed, internal friction causes high-energy losses to occur. The loss factor is used to quantify the level of hysteretic damping of a material. The loss factor (η) is the ratio of energy dissipated from the system to the energy stored in the system for every oscillation.

The damping ratio (ζ) of the DEAP actuator can be estimated using half power bandwidth method as (4).

$$\zeta = \frac{\omega_u - \omega_l}{2\omega_r} \quad (4)$$

ω_u is half-power upper frequency and ω_l is the half-power lower frequency. ω_r is the resonance frequency. Thus loss factor of the actuator can be determined by,

$$\eta = 2\zeta \quad (5)$$

In this experiment m_{total} is sum of M_1 and M_2 . Fig. 8 shows the loss factor of flat DEAP PolyPower pull actuator decreases as mass attached to it increasing. The highest loss factor occurred at mass M_2 equal to 0.02 kg. Then it decreases as mass M_2 is added. The increasing value of loss factor at the end of experiment, is perhaps due to the actuator starting flipping in horizontal direction.

On the other hand, the viscous damping factor has influence on amplitude at resonance. As a result, increasing damping factor reduces amplitude of resonance as shown in Fig. 7 (a).

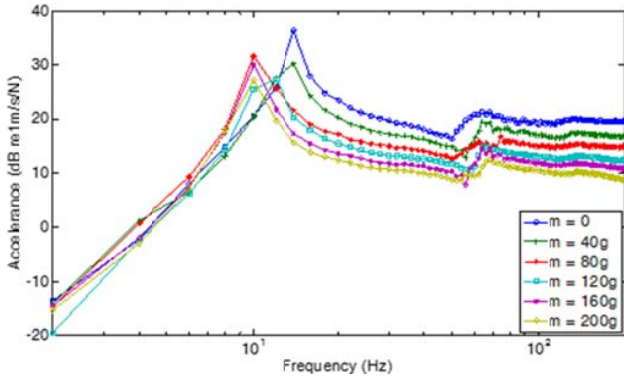

(a)

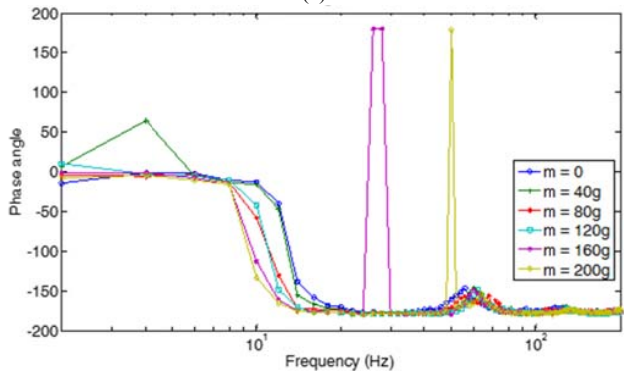

(b)

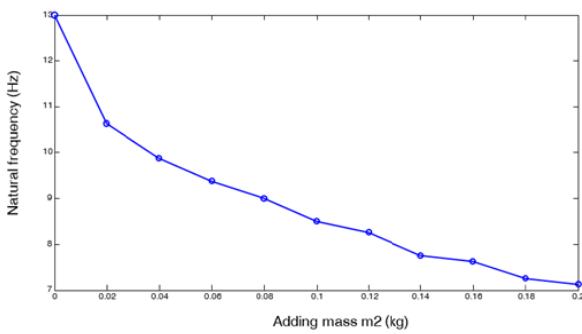

(c)

Fig. 7 (a) Changes of natural frequency as M_2 increasing (b) Phase angle (c) Relationship total mass and natural frequency

Most elastomeric engineering materials for vibration isolation use a mechanism known as hysteretic damping to

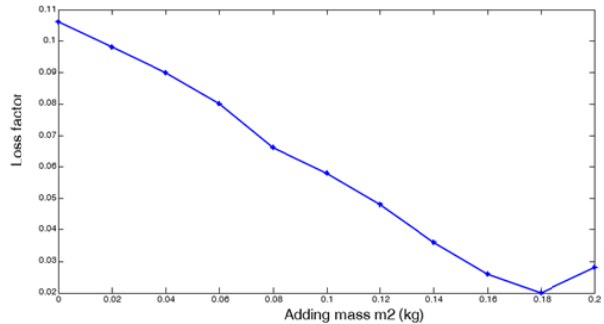

Fig. 8 Loss factor – Mass

IV. ELECTROMECHANICAL TESTING

The electromechanical (active) characteristics of DEAP actuators are of primary importance because these characteristics contain information about the actuation range and force, speed, stroke, efficiency and effectiveness of the actuators. This section explains the electromechanical characteristics of flat DEAP PolyPower pull actuator. The static electromechanical experiment showed the relationship between voltage and the displacement or deformation of actuator. In this experiment DC voltage was applied and deformation of flat DEAP PolyPower pull actuator was recorded. Graph Voltage–Displacement was plotted to show the relationship between voltage and displacement of actuator. Before that, the effect of voltage to natural frequency and damping loss was investigated. In this experiment, flat DEAP

PolyPower pull actuator was supplied by voltage during dynamic testing. Accelerance due to voltage was recorded and compared with accelerance without any voltage applied.

In addition, the dynamic electromechanical characteristic was investigated by applying AC voltage to the actuators and recording the changes in displacement (deformation). Fast Fourier Transform (FFT) was required to investigate the amplitude and phase changes during the dynamic electromechanical experiments. For this experiment Trek model P0621N high voltage amplifier was used for the high voltage supply.

A. Charge Dynamic Characteristics

The charge dynamic testing has been conducted to observe the effect of voltage to DEAP PolyPower pull actuator characteristic. Fig. 4 shows the diagram and the setting of equipment for the experiment.

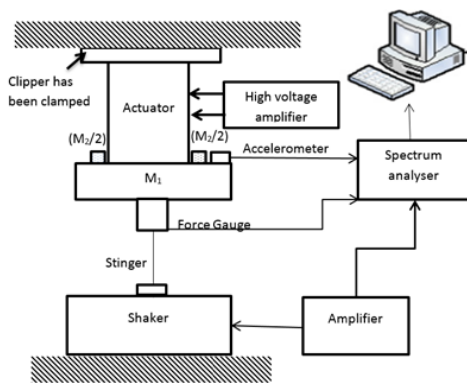

Fig. 9 Charge dynamic testing for Polypower DEAP pull actuator

DC voltage has been applied to the actuator. The applied voltage increased in step of 500V up to 2000V by Trek high voltage amplifier. Due to safety reason, it was not possible to attach the shaker to the DEAP actuator while high voltage was supplied to it. For this reason, the following process needed to be followed. First the elongation of actuator due to voltage was recorded. Then high voltage amplifier was switched off and a weight was used to achieve a similar elongation as recorded. Next shaker was attached to actuator and weight dismount from actuator. The corresponding voltage was applied and shaker was activated. In addition mass M_2 was attached to the actuator to investigate the effect of the mass to the system.

The effect of voltage to the dynamic characteristic of flat DEAP PolyPower pull actuator was investigated by comparing the accelerance during voltage applied and without applying voltage. Fig. 10 (a) shows the accelerance graph for voltage supplied at 0 V, 500 V, 1000V and 2000 V. There was no additional mass ($M_2 = 0g$) applied. Figs. 10-12 show the effect of voltage supplied to accelerance and phase angle for different additional mass, M_2 .

From the observation, there are no large changes in amplitude and phase of the accelerance as voltage is applied. Therefore, it can be concluded that voltage does not change

the dynamic characteristics of flat DEAP pull actuator.

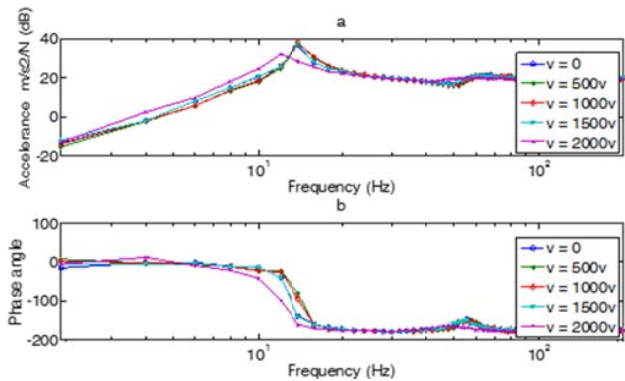

Fig. 10 (a) Accelerance and (b) Phase angle not changing for additional constant mass $M_2 = 0g$ and varying voltages, 0V, 500V, 1000V, 1500V and 2000V

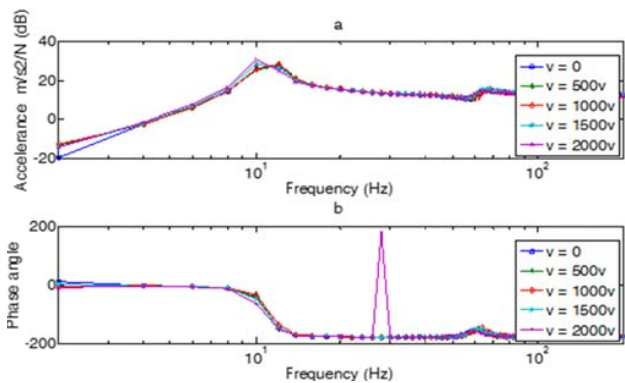

Fig. 11 (a) Accelerance and (b) Phase angle not changing for additional constant mass $M_2 = 120g$ and varying voltages, 0V, 500V, 1000V, 1500V and 2000V

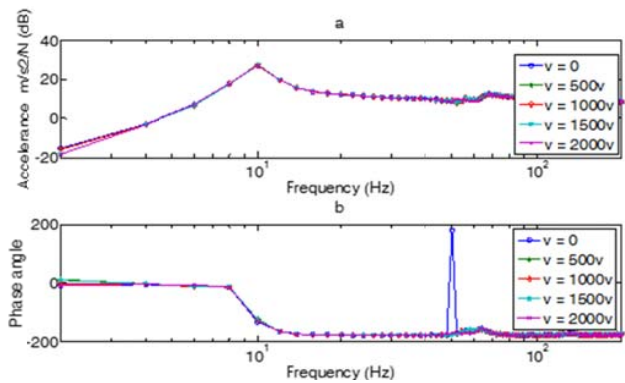

Fig. 12 (a) Accelerance and (b) Phase angle not changing for additional constant mass $M_2 = 200g$ and varying voltages, 0V, 500V, 1000V, 1500V and 2000V

Changes in resonance frequency and accelerance magnitude above the resonance frequency are shown in Figs. 13-15. These are due to the changes in the suspended mass, in line with single-degree-of-freedom models.

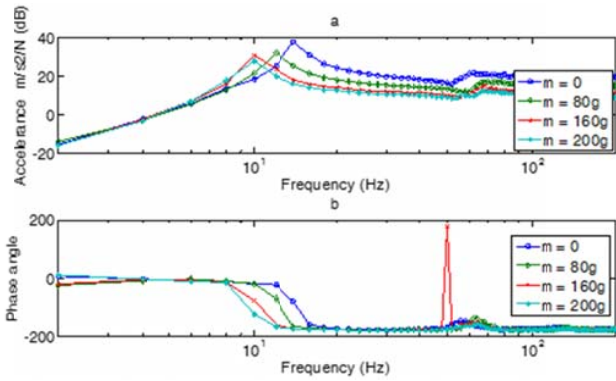

Fig. 13 (a) The natural frequency and (b) phase angle of actuator decreasing due varies mass M_2 , 0g, 80g,160g and 200g at 500V DC voltage supplied

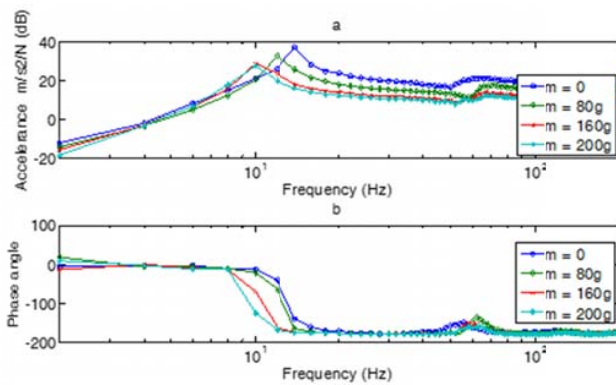

Fig. 14 (a) The natural frequency and (b) phase angle of actuator decreasing due varies mass M_2 , 0g, 80g,160g and 200g at 1500V DC voltage supplied.

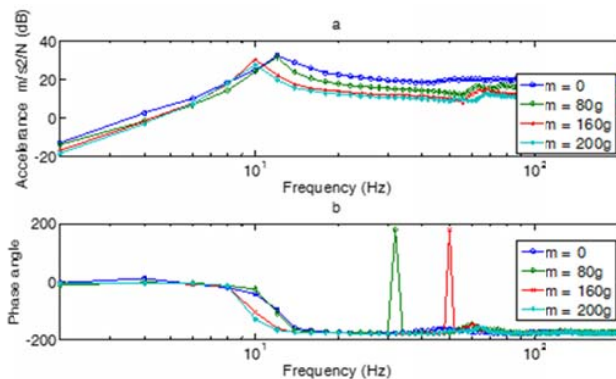

Fig. 15 (a) The natural frequency and (b) phase angle of actuator decreasing due varies mass M_2 , 0g, 80g,160g and 200g at 2000V DC voltage supplied

B. Electromechanical Characteristics

The electromechanical characteristics of flat DEAP PolyPower pull actuator were investigated by analyzing the relationship between voltage and deformation (displacement) of actuator. Fig. 16 shows the experiment setting. In this experiment, DC voltage was applied by Trek high voltage amplifier and displacement of actuator was recorded. The

applied voltage increased in step of 500V up to 2000V by Trek high voltage amplifier. The elongation of actuator due voltage applied was recorded and graph voltage-deformation was plotted to show the relationship. Keyence laser displacement sensor was used to measure the displacement occurred. Fig. 17 shows the diagram for this experiment.

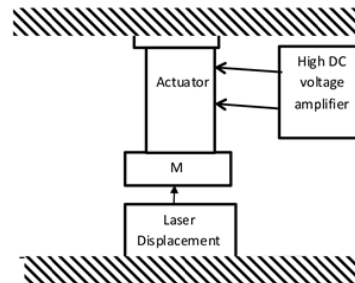

Fig. 16 Voltage-Deformation experiment for DEAP Polypower pull actuator

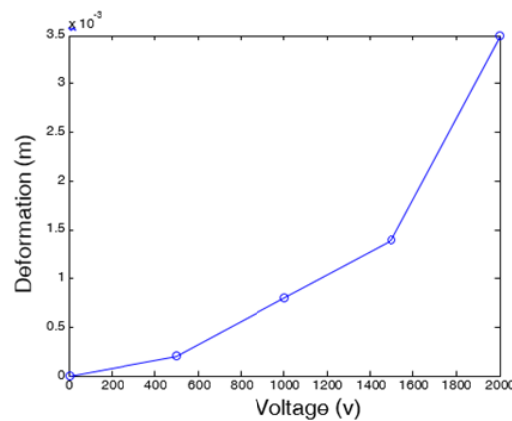

Fig. 17 Voltage-Displacement characteristic of DEAP Polypower pull actuator

Fig. 17 shows the relationship between displacements of flat DEAP PolyPower pull actuator and voltage. It can be seen that, the voltage has non-linear relationship with deformation. This result is in line with [6] who proved that deformation of DEAP actuator is nonlinear. Voltage is quadratic proportional with displacement hence, proved that flat DEAP PolyPower pull actuator is a nonlinear electromechanical device.

C. Dynamic Electromechanical Characteristics

Harmonic electrical inputs have been used to stimulate the DEAP actuator to achieve harmonic condition. The output displacement of DEAP PolyPower actuator strongly depends on stimulus amplitude, bias level and frequency due to the nonlinear electromechanical coupling.

The setup of Fig. 18 is used to investigate flat DEAP PolyPower pull actuator characteristics for harmonic electrical stimuli. The actuator is stimulated with sinusoidal input voltages with peak-to-peak values at 500V, 1000V, 1500V and 2000V. Frequency for each value of voltage has been changing in step of 3Hz up to 21Hz. The coefficient for each

data has been determined by Fourier series calculation and graph Amplitude-Frequency for each voltage has been plotted.

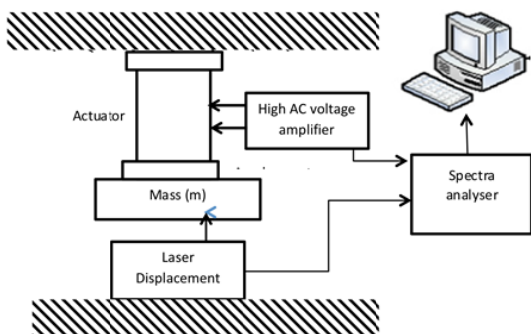

Fig. 18 AC voltage harmonic testing for flat DEAP pull actuator

Figs. 19-22 show the coefficient and phase angle of flat DEAP pull actuator for voltages at 500V, 1000V, 1500V and 2000V at varying frequency. It can be seen that the highest magnitude cross the frequency for each voltage occurs at around 12 Hz. This is the natural frequency of flat DEAP PolyPower pull actuator that has been determine during dynamic testing. In this experiment the magnitude for first coefficient give the maximum value. Therefore, value for first coefficient is used to compare the magnitude produced by flat DEAP pull actuator at varying voltage.

Fig. 23 shows that the stroke reducing across the frequency but increasing near to natural frequency. Beyond the natural frequency, amplitude decreases for similar voltage (constant input amplitude). It can be seen that at lower frequency the stroke amplitude of actuator higher compare to high frequency.

On the other hand, higher voltage gives higher amplitude but only before natural frequency. At higher frequency the amplitude is low and almost similar for different voltage. From this result, it can be concluded that, the amplitude of DEAP PolyPower folded actuator was dependent more on frequency of voltage supplied rather than the amplitude of the voltage supplied. This result is in line with [9] who suggested that the performance of elastomer actuator was dominated by the frequency dependence of the elastic response and was less influenced by dielectric properties. In fact dielectric constants remain roughly constant in all materials over the frequency range considered.

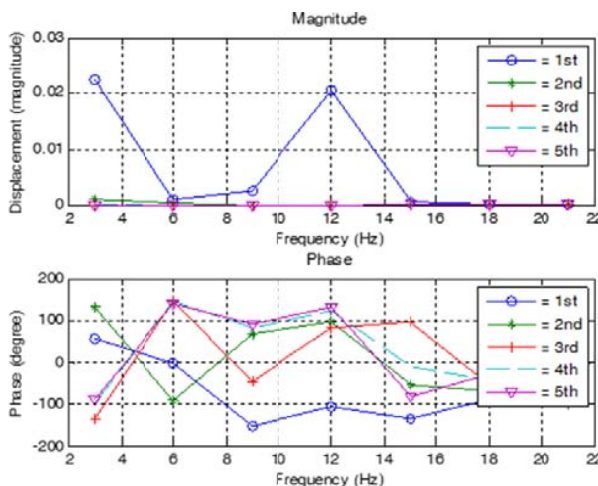

Fig. 19 Magnitude displacement and phase angle for 500 V at varies frequency

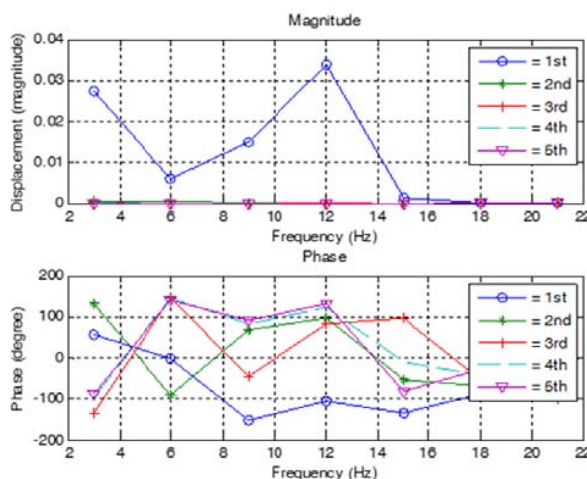

Fig. 20 Magnitude displacement and phase angle for 1000 V at varies frequency

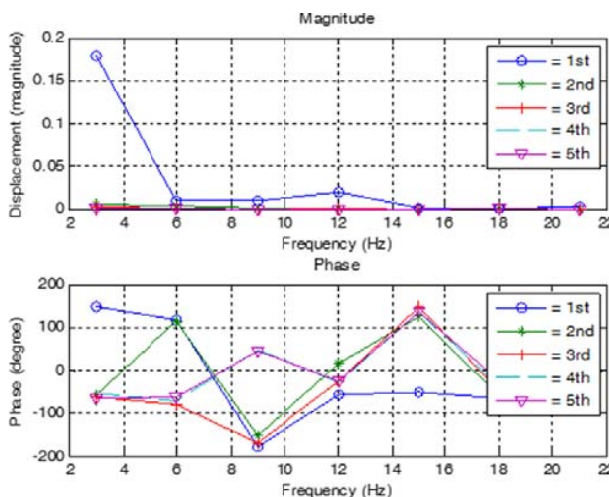

Fig. 21 Magnitude displacement and phase angle for 1500 V at varies frequency

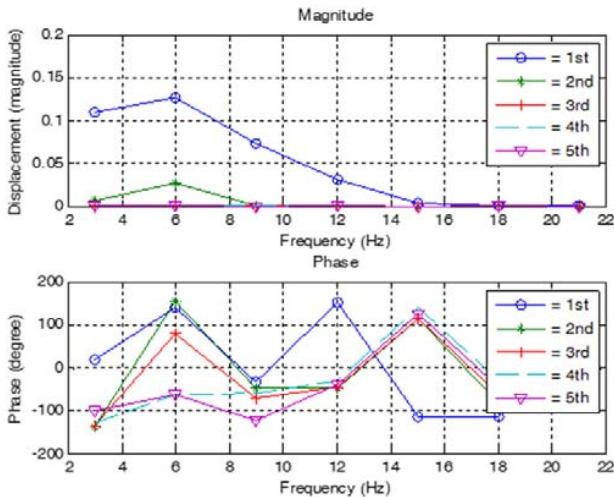

Fig. 22 Magnitude displacement and phase angle for 2000 V at varies frequency

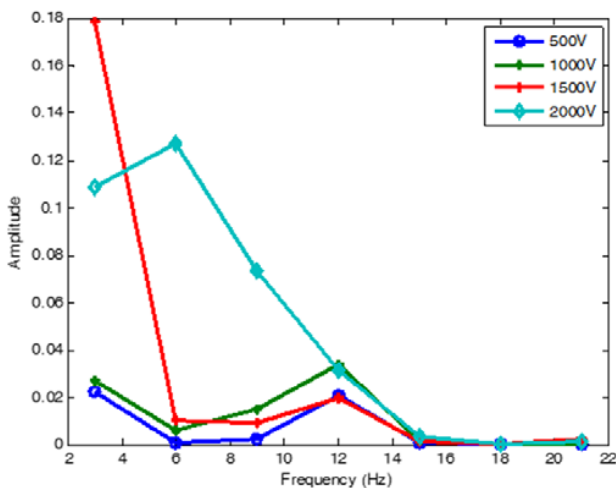

Fig. 23 Amplitude-Frequency graph plotted for first harmonic response of DEAP PolyPower pull actuator

V. CONCLUSION

The main objective of this work was to investigate the characterization of PolyPower folded actuator as a 'pull' actuator for vibration control. A range of experiment was carried out on folded actuator including passive (without electrical stimulation) and active (with electrical stimulation) testing. For both categories static and dynamic testing have been done to determine the behavior of folded DEAP PolyPower actuator.

The Force-Strain experiment has been conducted to estimate the stiffness of the actuator. In this work Hooke model has been used with good approximation. As a result natural frequency of the actuator can be calculated based on vibration theory. Thus, dynamic testing has been conducted to determine natural frequency and loss factor of actuator. The mass effect to this characteristic also has been investigated which is in line with vibration theory. This experiment has

been done without any voltage stimuli (passive). This result is important to determine the range of bandwidth for DEAP PolyPower folded actuator working.

On the other hand, Voltage-Strain experiment determines that DEAP PolyPower pull actuator is non-linear system. The voltage supplied has no effect on natural frequency that shows by active dynamic testing. Finally, varying amplitude and frequency of the AC voltage highlighted the parameters that influence the performance of DEAP pull actuator. As a result, the actuator performance is dominated by the frequency dependence of the elastic response and less influenced by dielectric properties.

Since this DEAP folded will be used as pull actuator, the hysteresis and Force-Voltage need to be examined. This experiment will look the efficiency and the force that can be produced by this actuator as voltage applied. Also, the mathematical modeling for active testing need to be considers in future for better understanding. In addition, the ability of this actuator as active control needs to be studied to determine the effectiveness of DEAP folded actuator as pull actuator in vibration control system. There are also some modifications to be done to the experimental rig in order to increase accuracy, especially a stable area for the mass to be attached.

APPENDIX

List of Devices

Accelerometer	PCB Piezotronics 352C22 (serial n. 652), PCB Piezotronics 352C22 (serial n. 657)
Actuator	DEAP PolyPower (serial n. 1098)
Amplifier	Sky Tronic Mini AV Digital Surround Amplifier (serial n. 103100)
Analyzer	Dp Physics connected with a DELL Core Two
Force Transducer	PCB Piezotronics ICP – 208 C 01 (serial n. 651)
Oscilloscope	Gold Star OS 9020 A
Shaker	LDS Model NV 201 (serial n. 71520-1)
CCd Laser Displacement Sensor	Lk-G series –Keyence
High-voltage power dc amplifier-	model (P0621N)-Trek

ACKNOWLEDGMENT

The authors would like to thank Danfoss PolyPower A/S who supplied the folded pull actuators. The authors would also like to acknowledge the Institute of Sound and Vibration Research (ISVR) and Tony Davies High Voltage at the University of Southampton where the dynamics and electromechanical experiments were carried out.

REFERENCES

- [1] R. Pelrine, R. Kornbluh, J. Joseph, R. Heydt, Q. Pei, and S. Chiba, "High-field deformation of elastomeric dielectrics for actuators," *Mater. Sci. Eng. C*, vol. 11, no. 2, pp. 89–100, 2000.
- [2] U. Berardi, B. Mace, E. Rustighi, and R. Sarban, "Dynamic Testing and Modelling of DEAP Push Actuators," in *Proc. ACTUATOR*, 2010, vol. 10.
- [3] Z. Suo, "Theory of dielectric elastomers," *Acta Mech. Solida Sin.*, vol. 23, no. 6, pp. 549–578, 2010.
- [4] F. Carpi, G. Frediani, A. Mannini, and D. De Rossi, "Contractile and buckling actuators based on dielectric elastomers: devices and applications," *Adv. Sci. Technol.*, vol. 61, pp. 186–191, 2009.
- [5] R. D. Kornbluh, R. Pelrine, J. Joseph, R. Heydt, Q. Pei, and S. Chiba, "High-field electrostriction of elastomeric polymer dielectrics for

- actuation,” in 1999 Symposium on Smart Structures and Materials, 1999, pp. 149–161.
- [6] R. Sarban, R. W. Jones, E. Rustighi, and B. R. Mace, “Active vibration isolation using a dielectric electro-active polymer actuator,” *J. Syst. Des. Dyn.*, vol. 5, no. 5, pp. 643–652, 2011.
- [7] R. Sarban and S. U. M. C. Institutet, *Active Vibration Control Using DEAP Transducers: PhD Thesis*. Mads Clausen Institute for Product Innovation, University of Southern Denmark, 2011.
- [8] G. Kofod, “Dielectric elastomer actuators,” *Chemistry (Easton)*, 2001.
- [9] M. Molberg, Y. Leterrier, C. J. G. Plummer, C. Walder, C. Löwe, D. M. Opris, F. A. Nüesch, S. Bauer, and J.-A. E. Manson, “Frequency dependent dielectric and mechanical behavior of elastomers for actuator applications,” *J. Appl. Phys.*, vol. 106, no. 5, p. 54112, 2009.