

Design and Control of an Integrated Plant for Simultaneous Production of γ -Butyrolactone and 2-Methyl Furan

Ahtesham Javaid, Costin S. Bildea

Abstract—The design and plantwide control of an integrated plant where the endothermic 1,4-butanediol dehydrogenation and the exothermic furfural hydrogenation is simultaneously performed in a single reactor is studied. The reactions can be carried out in an adiabatic reactor using small hydrogen excess and with reduced parameter sensitivity. The plant is robust and flexible enough to allow different production rates of γ -butyrolactone and 2-methyl furan, keeping high product purities. Rigorous steady state and dynamic simulations performed in AspenPlus and AspenDynamics to support the conclusions.

Keywords—Dehydrogenation and hydrogenation, Reaction coupling, Design and control, Process integration.

I. INTRODUCTION

COUPLING of exothermic and endothermic reactions is one of the methods for process intensification in which both material and energy can be utilized. Coupling could be hydrogenation with dehydrogenation, oxidation with reduction, or hydration with dehydration. Size of equipment can be reduced by reaction coupling. Researchers have studied the possibility of coupling for many reactions in the same units, which resulted in simpler reactor of reduced size and energy savings [1]. These energy savings combined with reduced reactor investment must outweigh cost of required additional units for separation [2]. Extensive reviews of different catalytic reactors used for coupling exothermic and endothermic reactions, in particular hydrogenation and dehydrogenation are provided [3], [4] respectively. Researchers worked extensively in this field, found this new process intensification very useful but their study is limited to reactor only. However, in few studies the interaction between reactor and separator (effect of recycle) is explored, by considering hypothetical system ($A \rightarrow P$, $B \rightarrow Q$). There were no studies or research regarding design and plantwide control of complete plant. Thus, this research is an attempt to fill that gap.

γ -butyrolactone (GBL) and 2-methylfuran (2-MF) are important intermediate chemicals. GBL is a versatile solvent and a raw material for the synthesis of herbicides, pyrrolidone, n-vinylpyrrolidone, n-methylpyrrolidone and rubber additives [5]. GBL can be manufactured in multi-tubular fixed-bed reactors by two methods: hydrogenation of maleic anhydride

(MA) and dehydrogenative cyclization of 1,4-butanediol (BDO). In particular, the BDO dehydrogenation is dominant in commercial applications [6]. The dehydrogenative cyclization of BDO to GBL in homogeneous [7] and heterogeneous catalyst systems [8] has been investigated previously. The catalytic dehydrogenation of BDO to GBL is an endothermic process shown as:

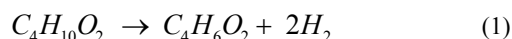

Reaction 2 shows the catalytic hydrogenation of furfural (FAL) in vapor phase to 2-methylfuran (2-MF) [9]. 2-MF is mainly used for the synthesis of perfume intermediates, cysanthemate pesticides, and chloroquine lateral chains in medical intermediates [10].

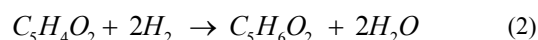

This reaction is highly exothermic and the temperature control of this process is very difficult, which leads to hot spots [9]. The yield of 2-MF is also affected by the non-uniform temperature profile in the reactors [11].

The coupling of BDO dehydrogenation and FAL hydrogenation in one integrated system has been suggested as a suitable way for proper utilization of hydrogen and to control the reaction temperature [10]-[12]. In the new coupled process, the heat released by FAL hydrogenation can be used for BDO dehydrogenation and hydrogen released by dehydrogenation of BDO can be utilized for the hydrogenation of FAL, with the result of much easier temperature control, better hydrogen mass balance and improved yield of 2-MF. In practice, this combined process can be carried out over the same Cu-Zn catalyst and under similar reaction conditions [13], [14]. The possibility of coupling BDO dehydrogenation and FAL hydrogenation in a single reactor is established in previous studies, but the design of the entire plant is missing. Therefore, this is the first instance of studying this coupled system in a complete plant. This article presents the design and plantwide control of an integrated plant. The proposed plant is robust and flexible to change the production rate of GBL and 2-MF.

The goal was achieved by assessing the possibility of carrying on two reactions simultaneously, in a stand-alone adiabatic reactor. Once succeeded, the detailed design of an integrated plant including sensitivity analysis was performed.

A. Javaid and C. S. Bildea are with University Politehnica of Bucharest, Strada Gh. Polizu 1-7, 011061 Romania (phone: +40 21 4023903; e-mail: ahteshamjavaid@hotmail.com, s_bildea@upb.ro).

The coupled plant was assessed in steady state using AspenPlus [15] and analyzed dynamically using AspenDynamics [16].

II. DESIGN PROCEDURE

The design of an integrated process is achieved using AspenPlus. By specifying recovery of light key & heavy key components, short-cut model for distillation column (DSTWU) is used to calculate the minimum number of trays N_{min} and the minimum reflux ratio R_{min} . The number of trays was set 2 N_{min} and the corresponding reflux ratio (R) was calculated, together with the feed tray and the distillate to feed ratio (D/F). These specifications are used by rigorous distillation model (RADFRAC). Small adjustments of R and D/F are made by means of the "Design Specification" option provided by the simulator for the required distillate and bottoms purities. The mixers, vapor-liquid or vapor-liquid-liquid separators are designed assuming residence time of 10 minutes and height to diameter ratio of 2:1.

Table I presents the main physical properties of the chemical species involved in the combined GBL and 2-MF process.

TABLE I
PHYSICAL PROPERTIES OF CHEMICAL SPECIES

Species	Boiling Point [°C]	Sol. In Water [g/l]	Destination
Hydrogen / [H ₂]	-253	-	Recycle
2-MF / [C ₅ H ₆ O]	66	3	Product
Water / [H ₂ O]	100	-	Product
FAL / [C ₃ H ₄ O ₂]	162	83	Recycle
FOL / [C ₃ H ₆ O ₂]	170	Miscible	Recycle
GBL / [C ₄ H ₆ O ₂]	204	Miscible	Product
BDO / [C ₃ H ₁₀ O ₂]	235	Miscible	Traces

Vapor-liquid separator is used to separate hydrogen from rest of the mixture, after purging hydrogen is recycled. 2-MF and water are separated from the mixture by first distillation setup. As the solubility of 2-MF in water is negligible so these two components get separated by simple liquid-liquid split. GBL is separated from the FOL in second distillation setup, as

a bottom product.

The kinetic parameters for BDO hydrogenation to GBL, on a CuO/Al₂O₃-ZnO-ZrO₂ catalyst, were taken from [17]:

$$r_{BDO} = k \cdot c_{BDO} \quad (3)$$

$$k = 468 \cdot \exp\left(-\frac{11525 \text{ kcal/kmol}}{RT}\right) \quad (4)$$

For furfural hydrogenation using Cu/SiO₂ as catalyst, the following kinetic parameters are taken from [18]:

$$k_1^* = 4.395 \times 10^{-6} \exp\left(-4049 \cdot \left(\frac{1}{T} - \frac{1}{543}\right)\right) \quad (5)$$

$$k_2^* = 1.488 \times 10^{-7} \exp\left(-4255 \cdot \left(\frac{1}{T} - \frac{1}{543}\right)\right) \quad (6)$$

It should be remarked that FAL hydrogenation is a highly exothermic process. For a H₂ to FAL ratio of 10 to 1, the adiabatic temperature rise is 287°C for hydrogenation to 2-MF. Consequently, the reaction is conventionally carried out in expensive multi-tubular reactor with cooling. In addition to large heat transfer area, a large amount of excess hydrogen is used (up to 100:1). Nevertheless, there is still a high risk of run-away.

III. INTEGRATED 1,4-BUTANEDIOL DEHYDROGENATION - FURFURAL HYDROGENATION PLANT

Fig. 1 presents the flowsheet of an integrated 1,4-butanediol (BDO) dehydrogenation - furfural (FAL) hydrogenation process. The reactants (BDO - 20 kmol/h, FAL - 10 kmol/h and hydrogen - 150 kmol/h) are mixed and brought to reaction temperature (250 °C). The reactions take place in a catalytic single tube adiabatic reactor (3.25 m diameter, 2.5 m length). The reactants ratio was chosen to balance each other's heat of reactions. The reactor is designed for the complete conversion of reactants so total conversion of BDO and FAL in reactor is achieved. Stream details are shown in Table II.

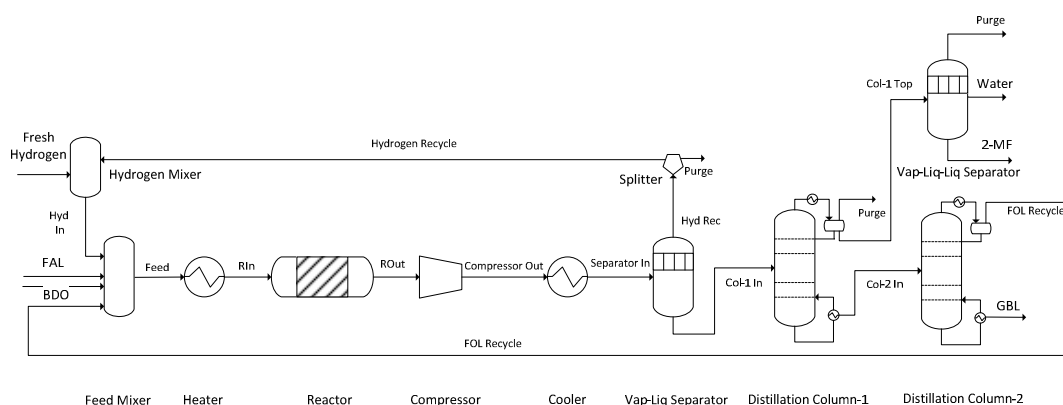

Fig. 1 Integrated 1,4-butanediol Dehydrogenation - Furfural Hydrogenation

TABLE II
STEAM TABLE

	FAL	BDO	H2IN	RIN	ROUT	SEP-IN	SEPOUT	FOLREC	2MF	GBL
Temperature / [°C]	25	25	5.1	250	314.7	5	5	167.3	5	215.3
Pressure / [bar]	1.5	1.5	1.5	1.49	1.39	10.1	10	1	1	1.34
Vapor Fraction	0	0	1	1	1	1	0	1	0	0
Mole Flow / [kmol/h]	10	20	150.66	181.28	211.28	211.28	40.57	0.617	10.14	19.95
Mass Flow / [kg/h]	960	1802	348	3168	3168	3168	2773	56.65	821	1717
Mole Fraction										
Hydrogen	0	0	0.996	0.827	0.805	0.805	0.002	0	151 PPM	0
Water	0	0	853 PPM	975 PPM	0.048	0.048	0.247	0.078	0.017	Trace
Furfural	1	0	2 PPB	0.055	5 PPM	5 PPM	26 PPM	0.001	16 PPM	13 PPB
Furfural Alcohol	0	0	210 PPB	0.003	0.003	0.003	0.015	0.917	0.001	500 PPM
2-methyl Furan	0	0	0.004	0.003	0.05	0.05	0.244	864 PPB	0.976	Trace
1,4-butanediol	0	1	0	0.11	0	0	0	0	0	0
γ -butyrolactone	0	0	6 PPM	16 PPM	0.095	0.095	0.493	0.003	0.006	1

Fig. 2 shows temperature and mole fraction profiles along the reactor length. For each reaction, the conversion of reactants into products is distributed along the reactor length. BDO reacts faster than FAL, which creates a local imbalance in heat consumption and generation.

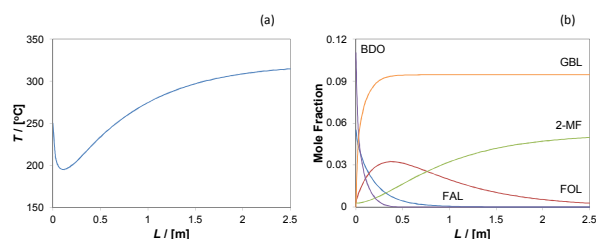

Fig. 2 Integrated Stand-alone Reactor Profiles: (a) Temperature (b) Molar

The reactor outlet is compressed to 10 bar and cooled to 5°C. Vapor - liquid separation is performed to separate hydrogen. The hydrogen is recycled, while the organic phase is separated, in a series of distillation columns, taking 2-MF and GBL as products. The design of distillation columns is summarized in Table III and distillation column profiles are shown in Figs. 3 and 4.

TABLE III
SUMMARY OF DISTILLATION COLUMN DESIGN

	Col-1	Col-2
Total Stages	8	35
Feed Stage	3	19
Reflux ratio	0.73	3.06
D/F	0.493	0.03
Pressure	1.5 bars	1 bars
Condenser Type	Partial Vap-Liq	Partial vapor
Condenser Temp	15 °C	--
Design specs		
Recovery	99.5 % Water in Top 99.7 % GBL in Bot	99.99 % GBL --
Purity	--	99.95 % GBL
Condenser duty	-0.4 MW	-0.2 MW
Reboiler duty	0.59 MW	0.2 MW

First column, operated at 1.5 bar, separates 2-MF and water from the mixture as top product. It has 8 stages and the required reflux ratio is 0.73. The condenser and reboiler duties are 0.4 MW and 0.59 MW, respectively. Liquid distillate (2-MF and Water) is sent and separated in liquid - liquid separator. As a result of separation 2-MF is recovered at about 95% purity. The mixture of un-reacted FAL (if any), FOL and GBL is fed to the second column which is operated at 1 bar, has 35 stages and the required reflux ratio is 3.06. The condenser and reboiler duties are 0.2 MW and 0.2 MW, respectively. GBL is obtained as a bottom product at the rate of 19.95 kmol/h with 99.95% purity. From the top, un-reacted FAL and FOL is recycled to be fed with fresh FAL.

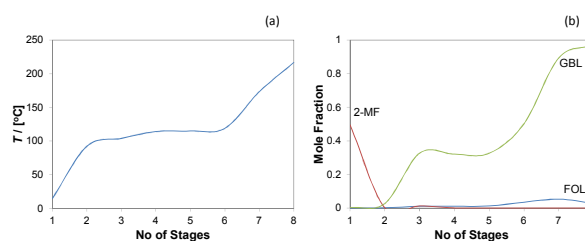

Fig. 3 Distillation Profiles of Column-1 (a) Temperature (b) Molar

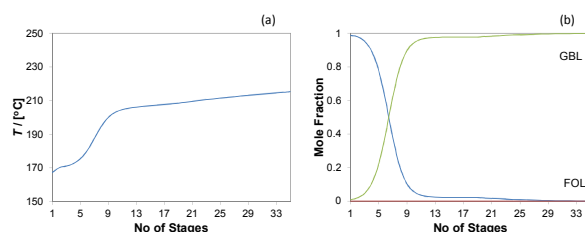

Fig. 4 Distillation Profiles of Column-2 (a) Temperature (b) Molar

IV. PLANTWIDE CONTROL

Dynamic simulation is a convenient method to analyze the performance of process control system. The dynamics of the plant is usually performed to prove the stability and the resiliency with respect to disturbances. The interaction between the reactor and the separation section, due to material

recycle, may be the source of undesired nonlinear phenomena [19], which leads to controllability problems. Controlling the reactants inventory can be performed in two ways [20]: a) by evaluating the inventory of each reactant and controlling it by feedback using corresponding fresh feed as manipulated variable; b) by fixing the fresh feed rate and using the self-regulation property of the mass balances [21].

We used the second strategy by fixing the flow rates of furfural and 1,4-butanediol at the plant inlet, with the advantage of varying the production by changing the flow rates of fresh reactants. The control of vapor-liquid, liquid-liquid separators and that of the distillation columns is standard. The liquid and vapor inventories are typically controlled by manipulating unit outlet flow rates. For the

distillation columns, quality control is achieved by keeping constant temperature in the top and bottom sections, by means of the reflux and reboiler duty, respectively. It was found that, the purity of the GBL product stream deviates from the required value on changing production rate so temperature in the bottom tray is controlled by reboiler duty. The control structure of the integrated plant is shown in Fig. 5.

The controllers are tuned by a simplified version of the direct synthesis method. The appropriate range of the controlled and manipulated variables was specified for each controller. The controller gain is set to 1 %/%. The integral time is set equal to the time constant of the process, (12 min for pressure and 20 min for temperature control loops). For the level controllers, a large reset time $\tau_i = 60$ min is chosen.

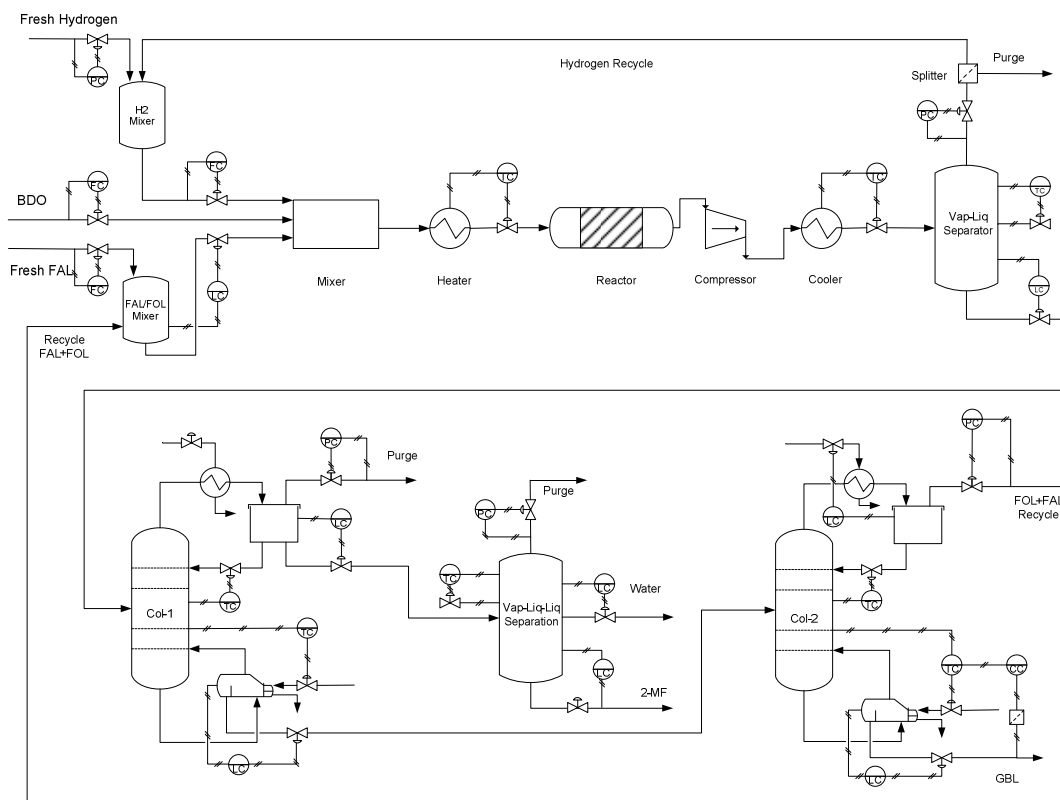

Fig. 5 Plantwide Control

V.DYNAMICS

The dynamic model of the plant is built in AspenDynamics, and the flexibility in obtaining different products is investigated. Dynamics simulation results are shown in Figs. 6 and 7 for production and product purity. All simulations started from a steady state corresponding to 20 kmol/h GBL production rate and the possibility to change the GBL and 2-MF production rates was investigated. All changes were introduced at time $t = 2$ hr.

In Fig. 6 the production rate of 2-MF is varied by changing with $\pm 10\%$ fresh FAL. The production rate of 2-MF is 10% increased and 10% decreased in Figs. 6 (a) and (b). After 2

hours of operation new steady state is achieved. The disturbances have no effect on products purities.

Similarly in Figs. 7 (a) and (b) the GBL production rate is changed by $\pm 10\%$ by changing flow rate of fresh BDO. New production rate is achieved in approximately 2 hours. The purity of GBL and 2-MF remain unchanged.

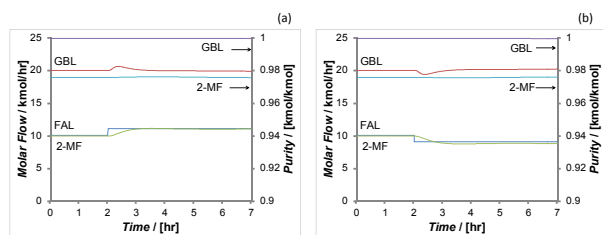
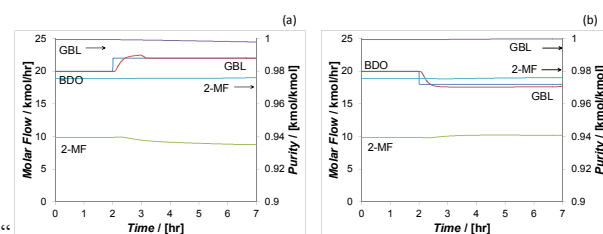
Fig. 6 Dynamics Results for $\pm 10\%$ FALFig. 7 Dynamics Results for $\pm 10\%$ BDO

VI. CONCLUSION

The integrated process for the simultaneous production of GBL and 2-MF can be carried out in a single tube adiabatic reactor with reduced parameter sensitivity and using small hydrogen excess. Steady state and dynamic simulation proves that the new coupled process is robust, controllable and flexible enough to manipulate the production rates of GBL and 2-methyl furan keeping high product purity.

REFERENCES

- [1] G. Towler, S. Lynn, "Novel applications of reaction coupling: use of carbon dioxide to shift the equilibrium of dehydrogenation reactions", *Chem. Eng. Sci.*, vol. 49, no. 16, pp. 2585-2591, 1994.
- [2] P. Altamari, C. S. Bildea, "Coupling Exothermic and Endothermic Reactions in Plug-Flow Reactor-Separation-Recycle Systems", *Ind. Eng. Chem. Res.*, vol. 47, no. 17, pp. 6685-6697, 2008.
- [3] M. R. Rahimpour, M. R. Dehnavi, F. Allahgholipour, D. Iranshahi, S. M. Jokar, "Assessment and comparison of different catalytic coupling exothermic and endothermic reactions: A review", *Applied Energy*, vol. 99, pp. 496-512, 2012.
- [4] C. V. Pramod, C. Raghavendra, K. Hari Prasad Reddy, G. V. Ramesh Babu, K. S. Rama Rao, B. David Raju, "Concept and progress in coupling of dehydrogenation and hydrogenation reactions through catalysts", *Journal of Chemical Sciences*, vol. 126, no. 2, pp. 311-317, 2014.
- [5] M. Messori, A. Vaccari, "Reaction Pathway in Vapor Phase Hydrogenation of Maleic Anhydride and Its Esters to γ -Butyrolactone", *Journal of Catalysis*, vol. 150, no. 1, pp. 177-185, 1994.
- [6] Kirk-Othmer's Encyclopedia of Chemical Technology, Eds. R. E. Kirk, F. Othmer, J. I. Kroschwitz, M. Howe-Grant, 2nd ed., New York, John Wiley & Sons, 1991.
- [7] K. Utsunomiya, K. Takahashi, T. Oshiki, K. Takai, Mitsubishi Kagaku K. K. Jpn. Kokai Tokkyo Koho, JP14-233762, 2002.
- [8] H. Koyama, Daicel Kagaku Kougyou K. K. Jpn. Kokai Tokkyo Koho, JP02-255668, 1990.
- [9] R. S. Rao, R. T. K. Baker, M. A. Vannice, "Furfural hydrogenation over carbon-supported copper", *Catalysis Letters*, vol. 60, no. 1-2, pp. 51-57, 1999.
- [10] Y.L. Zhu, H.W. Xiang, Y.W. Li, H. Jiao, G.S. Wu, B. Zhong and G.Q. Guoc, "A new strategy for the efficient synthesis of 2-methylfuran and γ -butyrolactone", *New Journal of Chemistry*, vol. 27, pp. 208-210, 2003.
- [11] N. Merat, C. Godawa and A. Gaset, "High selective production of tetrahydrofurfuryl alcohol: Catalytic hydrogenation of furfural and

furfuryl alcohol", *Journal of Chemical Technology and Biotechnology*, vol. 48, no. 2, pp. 145-159, 1999.

- [12] H. Y. Zheng, J. Yang, Y.L. Zhu, G.W. Zhao, "Synthesis of γ -butyrolactone and 2-methylfuran through the coupling of dehydrogenation and hydrogenation over copper-chromite catalyst", *React. Kinet. Catal. Lett.*, vol. 82, no. 2, pp. 263-269, 2004.
- [13] J. G. M. Bremner, R. K. F. Keeys, "The hydrogenation of furfuraldehyde to furfuryl alcohol and sylvan (2-methylfuran)", *Journal of Chemical Society*, pp. 1068-1080, 1947.
- [14] I. Tatsumi, K. Kenji, S. Sadakatsu, U. Hiroshi, Euro Patent, 584408, 1994.
- [15] ASPENTECH, AspenPlus Getting Started Building and Running a Process Model, ASPEN Technology, Burlington, 2010.
- [16] ASPENTECH, AspenDynamics User Guide, ASPEN Technology, Burlington, 2009.
- [17] N. Ichikawa, S. Sato, R. Takahashi, T. Sodesawa, K. Inui, "Dehydrogenative cyclization of 1,4-butanediol over copper-based catalyst", *Journal of Molecular Catalysis A: Chemical*, vol. 212, no. 1-2, pp. 197-203, 2004.
- [18] S. Sithisa, T. Sooknoi, Y. Ma, P. B. Balbuena, D. E. Resasco, "Kinetics and mechanism of hydrogenation of furfural on Cu-SiO₂ catalysts", *Journal of Catalysis*, vol. 277, pp. 1-13, 2011.
- [19] P. Altamari, C. S. Bildea, "Integrated design and control of plantwide systems coupling exothermic and endothermic reactions", *Computers & Chemical Engineering*, vol. 33, no. 4, pp. 911-923, 2009.
- [20] C. S. Bildea, A. C. Dimian, "Fixing Flow Rates in Recycle Systems: Luyben's Rule Revisited", *Industrial & Engineering Chemical Research*, vol. 42, no. 20, pp. 4578-4585, 2003.
- [21] Practical Distillation Control, Ed. W. L. Lyben, New York, Springer, 1993.