

Comparative Study of Line Voltage Stability Indices for Voltage Collapse Forecasting in Power Transmission System

H. H. Goh, Q. S. Chua, S. W. Lee, B. C. Kok, K. C. Goh, K. T. K. Teo

Abstract—At present, the evaluation of voltage stability assessment experiences sizeable anxiety in the safe operation of power systems. This is due to the complications of a strain power system. With the snowballing of power demand by the consumers and also the restricted amount of power sources, therefore, the system has to perform at its maximum proficiency. Consequently, the noteworthy to discover the maximum ability boundary prior to voltage collapse should be undertaken. A preliminary warning can be perceived to evade the interruption of power system's capacity. The effectiveness of line voltage stability indices (LVSI) is differentiated in this paper. The main purpose of the indices used is to predict the proximity of voltage instability of the electric power system. On the other hand, the indices are also able to decide the weakest load buses which are close to voltage collapse in the power system. The line stability indices are assessed using the IEEE 14 bus test system to validate its practicability. Results demonstrated that the implemented indices are practically relevant in predicting the manifestation of voltage collapse in the system. Therefore, essential actions can be taken to dodge the incident from arising.

Keywords—Critical line, line outage, line voltage stability indices (LVSI), maximum loadability, voltage collapse, voltage instability, voltage stability analysis.

I. INTRODUCTION

ESSENTIALLY, voltage instability is a non-linear phenomenon. The instability is demonstrated when the network is being fully utilized up until it crosses the maximum deliverable power limits. The main motivations for transmission network improvements and enlargements are dependable considerations and interconnection of new generation resources. Despite that, some economic criteria and environmental consideration should be taken into account and hence will cause the planning to be postponed [1]. Moreover, the rapid increasing of implementation of renewable energy is prone to cause the transmission network to be more complicated and stressed, since these sources have a higher and random behavior.

H. H. Goh, Q. S. Chua, S. W. Lee and B. C. Kok are with the Department of Electrical Power Engineering, Faculty of Electrical and Electronic Engineering, Universiti Tun Hussein Onn Malaysia, 86400 Parit Raja, Batu Pahat, Johor, Malaysia (corresponding author phone: +60(167416824); e-mail: hhgoh@uthm.edu.my).

K. C. Goh is with the Department of Construction Management, Faculty of Technology Management and Business, Universiti Tun Hussein Onn Malaysia, 86400 Parit Raja, Batu Pahat, Johor, Malaysia.

K. T. K. Teo is with the Modelling, Simulation and Computing Laboratory, Level 3, Block C, School of Engineering and Information Technology, Jalan UMS, Universiti Malaysia Sabah, 88400 Kota Kinabalu, Sabah, Malaysia.

Present-day, a number of blackouts interconnected to the voltage stability issue have happened in several countries. The greatest quantities of major blackouts took place in the year 2003. The United States (U.S.)-Canadian blackout took place on August 14, 2003. During the blackout, an estimated value of 50 million people was affected in eight U.S. states and two Canadian provinces. Approximately, 63 GW of load was interrupted, which equals to 11 % of the total serving load in the Eastern Interconnection of the North American system. According to the reports, more than 400 transmission lines and 531 generating units at 261 power plants tripped [2], [3]. Subsequently, on September 23, 2003, a major blackout took place in Southern Sweden and Eastern Denmark and has an impact on 2.4 million customers [3], [4]. Five days later on September 28, 2003, some other major blackout began when a tree flash over caused the tripping of a major tie-line between Italy and Switzerland [5], [6].

The total number of power systems outages throughout the world is illustrated in Fig. 1. It shows a significant growth for the power systems outages during the last decade. Besides that, it also shows the trend still expanding.

Worldwide Power Systems Outages

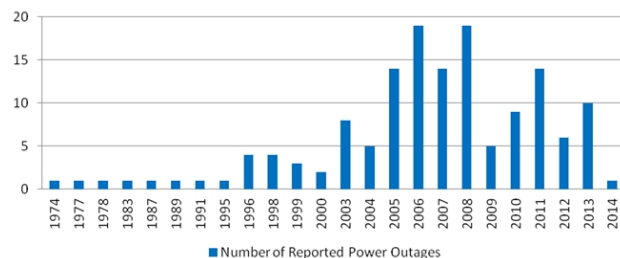

Fig. 1 Total number of worldwide power systems outages (until February 2014)

Voltage stability assessment and control are not considered as any new issue [7], but they have now attained special attentions to maintain the stability of the transmission networks in order to avoid recurrence of major blackouts as experienced by the particular countries. The power system can be classified in the voltage stability region if it can maintain steady acceptable voltages at all buses in the system under normal operating conditions and after being subjected to a disturbance [8], [9]. In order to be reliable, the power system must be stable most of the time. The study on voltage stability can be break down into various approaches, but the estimation

on the power system's distance towards voltage collapse can be very handy to the operators before they take any remedial actions [10]. The details on the distance towards voltage instability can be obtained by using Voltage Stability Indices (VSI) [11].

In general, stability studies required a dynamic model of the power system. By comparing the static and dynamic approaches, the static approach presents some benefits such as provides relevant results from the practical standpoint and also less computational effort [12], [13]. In this paper, the investigation of voltage stability was conducted by utilizing the static tools.

A small group of previous researched works have been proposed by performing the voltage stability analysis such as the P-V [14] and Q-V [15] curves, modal analysis [16], [17] and sensitivity analysis [18]. The P-V and Q-V curves lead to proximity towards voltage collapse while the others developed voltage stability indices as indicators [19]. These stability indices are attained either to a bus or a line.

The line stability indices [20] are suitable to evaluate the online voltage stability condition since they can be assessed without shutting down the generators. Moreover, the line stability indices can be used to identify the point of voltage collapse, maximum permissible load, weak bus in the system and the most critical line in an inter-connected system [19], [21].

The IEEE 14 bus reliability test system is used to study the comparison of the performance of the selected line stability indices for validation purposes. The comparison is made between the Lmn index proposed in the reference number as in [20], the FVSI index proposed as in reference number [19], the LQP index proposed in the reference number as in [22], and the VCPI(Power) and VCPI(Losses) indices as proposed in [23].

II. BACKGROUND OF STUDY

A. Definitions of Voltage Stability

Voltage stability can be explained to the potential of the power system to sustain steady voltages at all buses in the system after being vulnerable to a disturbance from a given initial operating condition. Besides that, voltage stability is resultant on the ability of the power system to maintain or restore the equilibrium between the load demand and load supply [8], [24].

During the occurrence of voltage instability, then the progressive fall or rise of voltages at some buses can be detected. The potential consequence of voltage instability is due to loss of load in the certain area, or tripping of transmission lines and other elements by the protection systems contributed to the cascading outages. Moreover, loss of synchronization for some generators may lead to the outages as well [25].

B. Voltage Stability Indices

Voltage stability indices are very applicable in order to retrieve the voltage stability of the power system. Voltage

stability indices are the scalar magnitudes that being implemented to observe the changes of the parameters in the system. Besides that, the indices are also used to quantify the distance of the particular operating point with the point of voltage collapse [26].

According to [27], [28], the authors stated that voltage stability indices particularly could be subdivided into two parts, which are Jacobian matrix based voltage stability indices and system variables based voltage stability indices.

Jacobian matrix based voltage stability indices are able to calculate the voltage collapse point or maximum load ability of the system and discover the voltage stability margin. However, these indices required high computational time and for this particular reason, the Jacobian matrix based voltage stability indices are not appropriate for online assessment. In the meanwhile, system variables based voltage stability indices required less computational time. The reasons are due to the system variable based voltage stability indices used the elements of the admittance matrix and some system variables such as bus voltages or power flow through the lines. With the benefit of less computational time, system variables based voltage stability indices are suitable to be implemented on the online assessment and monitoring purposes. However, system variables based voltage stability indices cannot efficiently estimate the margin because their responsibilities more to determine the critical lines and buses.

III. VOLTAGE STABILITY INDICES FORMULATION

Principally, 5 different types of line voltage stability indices are being implemented in this paper. They are Lmn index, FVSI index, LQP index, VCPI (Power) index and VCPI (Losses) index. The data is gathered by using PowerWorld simulator, and the calculations for the indices are performed by using Matlab.

A. Line Stability Index (Lmn)

The line stability index was proposed in reference number as listed in [20] and is formulated based on a power transmission concept in a single line. A single line in an interconnected network is being provided in Fig. 2.

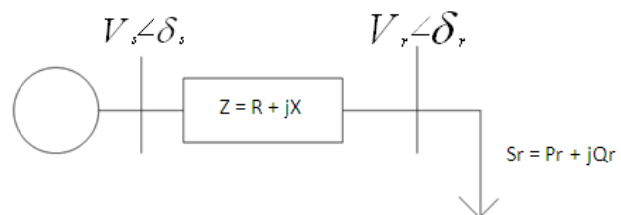

Fig. 2 One line diagram of transmission line

The line stability index (Lmn) can be reproduced as in (1).

$$Lmn = \frac{4 \cdot Q_r \cdot x}{[|V_s| \cdot \sin(\theta - \delta)]^2} \quad (1)$$

where: V_s and V_r are the sending end and receiving end voltages respectively; δ_s and δ_r are the phase angle at the sending and receiving buses;

$$\delta = \delta_r - \delta_s$$

Z is the line impedance; R is the line resistance; X is the line reactance; θ is the line impedance angle; P_r is the active power at the receiving end; Q_r is the reactive power at the receiving end.

Lines that present values of Lmn close to 1, indicates that those lines are closer to their instability points. In order to maintain a secure condition for the power systems, the Lmn index should be maintained less than 1.

B. Fast Voltage Stability Index (FVSI)

The fast voltage stability index, FVSI proposed in reference number [19] is based on a concept of power flow through a single line. For the interconnected transmission line, the stability index is calculated by (2).

$$FVSI_{ij} = \frac{4 \cdot Z^2 \cdot Q_j}{V_i \cdot X} \quad (2)$$

where: Z is the line impedance; X is the line reactance; Q_j is the reactive power flow at the receiving end; V_i is the sending end voltage.

The line that exhibits FVSI closed to 1 indicates that it is approaching its instability point. If FVSI goes beyond 1 or unity, one of the buses that connected to the line will experience a sudden voltage drop leading to system collapse.

Besides that, the calculated FVSI can also be used to identify the weakest bus on the system [29]. The most exposed bus in the system corresponds to the bus with the smallest maximum permissible load.

C. Line Stability Factor (LQP)

The LQP index in (3) is derived by A. Mohamed *et al.* and is obtained using the same theory as (1) and (2).

$$LQP = 4 \left(\frac{X}{V_i} \right) \left(\frac{X}{V_i} P_i^2 + Q_j \right) \quad (3)$$

where: X is the line reactance; P_i is the active power flow at the sending bus; Q_j is the reactive power flow at the receiving bus; V_i is the voltage on sending bus.

In order to maintain a secure condition, the value of LQP index must be maintained less than 1.

D. Voltage Collapse Point Indicators (VCPI)

The voltage collapse point indicators (VCPI) proposed in reference number [23] are based on the concept of maximum power transferred through a line.

$$VCPI_{(Power)} = \frac{P_r}{P_{r(max)}} \quad (4)$$

$$VCPI_{(Losses)} = \frac{Q_r}{Q_{r(max)}} \quad (5)$$

The denominator is the maximum power that can be transferred to the receiving end. Hence, the maximum power at the receiving end can be calculated by using (6) and (7) subsequently.

$$P_{r(max)} = \frac{V_s^2}{Z} \cdot \frac{\cos \phi}{4 \cos^2 \left(\frac{\theta - \phi}{2} \right)} \quad (6)$$

$$Q_{r(max)} = \frac{V_s^2}{Z} \cdot \frac{\sin \phi}{4 \cos^2 \left(\frac{\theta - \phi}{2} \right)} \quad (7)$$

where:

$$\phi = \tan^{-1} \left(\frac{Q_r}{P_r} \right)$$

$$\cos^2 \left(\frac{\theta - \phi}{2} \right) = \frac{1}{2} + \frac{1}{2} \cos (\theta - \phi)$$

With the increasing power flow transferred by transmission lines, the values of VCPI (power) and VCPI (losses) increase slowly, and when the indices reach 1, the voltage collapse occurs. The value of VCPI varies from 0 (no-load condition) to 1 (voltage collapse).

E. IEEE 14 Bus System

In order to validate the effectiveness of the line stability indices, a study has been made in IEEE 14 bus system. Hence, the critical system nodes and transmission branches can be identified easily.

The calculations for the stability indices for each line were developed by using the Matlab program with the integration of the data provided by PowerWorld.

Basically, the IEEE 14 bus test system has 5 generators, 11 loads and 20 interconnected branches. The one-line diagram for IEEE 14 bus system is illustrated in Fig. 3.

TABLE I
LINE STABILITY INDICES FOR IEEE 14 BUS TEST SYSTEM WITH BASE CASE LOADING

Load (p.u.)	Line	Lmn	FVSI	LQP	VCPI(P)	VCPI(L)
Q10	9-10	0.015	0.014	0.013	0.020	0.020
=0.058	10-11	0.013	0.013	0.011	0.026	0.026
Q11	6-11	0.030	0.029	0.024	0.055	0.055
=0.018	10-11	0.013	0.013	0.012	0.027	0.027
Q14	9-14	0.041	0.040	0.035	0.090	0.090
=0.050	13-14	0.026	0.026	0.022	0.068	0.068

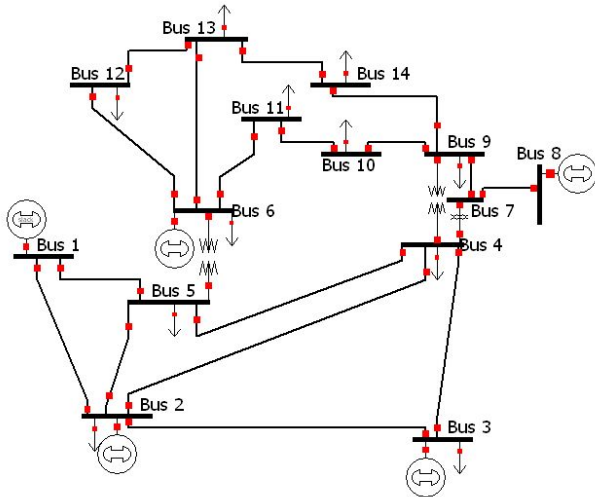

Fig. 3 IEEE 14 bus test network

IV. RESULT AND DISCUSSION

A test was conducted on the IEEE 14 bus test system. Three load buses were randomly chosen in order to investigate the effect of reactive power loading on the 5 indices as mentioned in Section III. Reactive loads at buses 10, 11 and 14 were gradually increased from the based case up until their maximum allowable load or maximum loadability which is the maximum load that could be injected to a load bus before the power flow solution diverges.

Lmn index, FVSI index, LQP index, VCPI (power) and VCPI (losses) indices were performed for each line in the system for every load increase. The line with the greatest index with respect to a load increase will be considered as the most critical line. Any further increment of the load will lead the line to have indices greater than 1.00 and caused the whole system to be unstable.

Table I showed the consensus between the different line stability indices. According to Table I, different voltage stability indices have been calculated for the system under base case loading and their values are presented in Table I. The first column is of the table shows the initial reactive load value for the particular bus. In the meanwhile, the second column shows the lines connected between sending end and receiving end nodes. The line voltage stability indices values are presented in column 3 to column 7 in accordance.

Fig. 4 shows the critical lines of the IEEE 14 bus test system for the line stability index (Lmn). The individual Lmn curve represented in Fig. 4 is the most critical line referred to a bus. For example, the line that connects bus 9 to bus 10 is the most critical line referred to bus 10. Besides that, the line 6-11 and line 9-14 are the most critical lines of the bus 11 and bus 14 subsequently.

In addition, Fig. 5 shows the critical lines of the IEEE 14 bus test system for the fast voltage stability index (FVSI). The individual FVSI curve represented in Fig. 5 is the most critical line referred to a bus. For instant, the line that connects bus 9 to bus 10 is the most critical line referred to bus 10. Besides

that, the line 6-11 and line 9-14 are the most critical lines of the bus 11 and bus 14 subsequently.

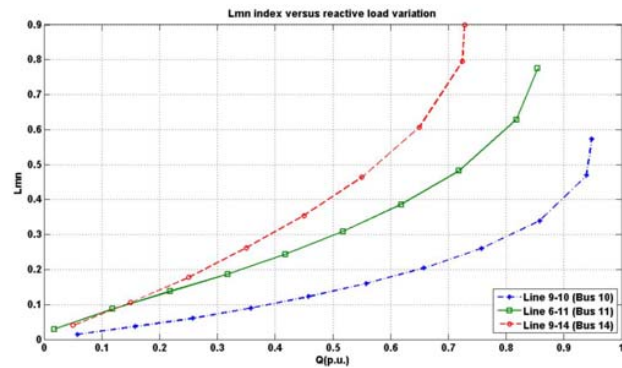

Fig. 4 Lmn versus reactive load variation for IEEE 14 bus test system

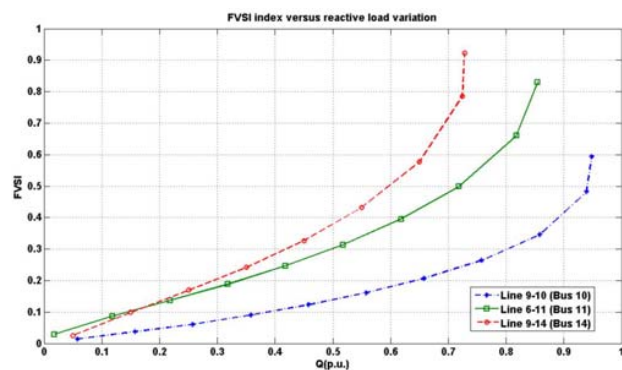

Fig. 5 FVSI versus reactive load variation for IEEE 14 bus test system

Moreover, Fig. 6 shows the critical lines of the IEEE 14 bus test system for the line stability factor (LQP). The individual LQP curve represented in Fig. 6 is the most critical line referred to a bus. For instant, the line that connects bus 9 to bus 10 is the most critical line referred to bus 10. Besides that, the line 6-11 and line 9-14 are the most critical lines of the bus 11 and bus 14 subsequently.

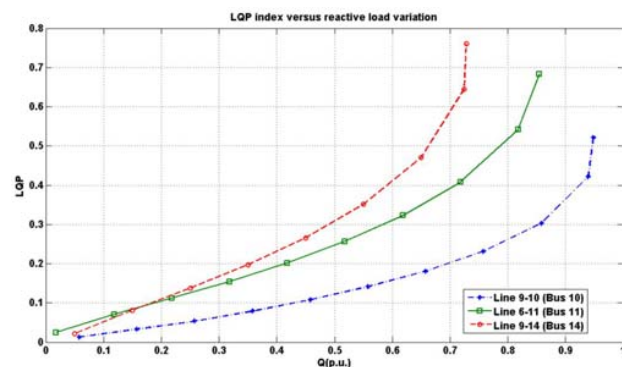

Fig. 6 LQP versus reactive load variation for IEEE 14 bus test system

Besides that, Figs. 7 and 8 show the critical lines of the IEEE 14 bus test system for the voltage collapse point

indicators, VCPI (power) and VCPI (losses). The individual VCPI (power) and VCPI (losses) curves represented in Figs. 7 and 8 are the most critical line referred to a bus. For instant, the line that connects bus 9 to bus 10 is the most critical line referred to bus 10. Besides that, the line 6-11 and line 9-14 are the most critical lines of the bus 11 and bus 14 subsequently.

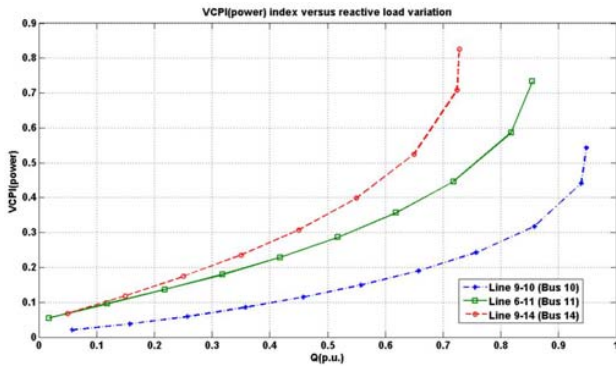

Fig. 7 VCPI (power) versus reactive load variation for IEEE 14 bus test system

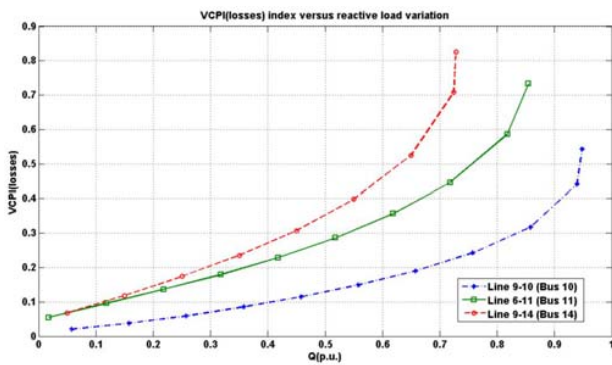

Fig. 8 VCPI (losses) versus reactive load variation for IEEE 14 bus test system

In order to determine the weak buses of the system, the reactive load at each load bus is slowly varied with the level of voltage collapse. All the line stability indices increase as the reactive power loading is increased. The reactive load to the bus where the line stability indices are close to 1 is considered as maximum permissible reactive load at that particular bus. The results are verified by using the 5 different types of line voltage stability indices such as Lmn, FVSI, LQP, VCPI (power) and VCPI (losses).

By referring to Table II, line 9-14 at bus 14 is the most critical line as the results are supported by the various types of line stability indices. Comparison of indices reveals that FVSI index is closest to 1 at the point of bifurcation. For the same loading, Lmn index, VCPI(P) index and VCPI(L) index show almost consistent results, but LQP index is found to be much less as compared with the other 4 indices.

Besides that, the line 6-11 is the most critical line referred to bus 11 because it presents the highest indices' values for the maximum loadability of the bus. Alike line 9-10 is the most

critical line with respect to bus 10.

TABLE II
LINE STABILITY INDICES FOR IEEE 14 BUS TEST SYSTEM WITH HEAVY REACTIVE LOADING

Load (p.u.)	Line	Lmn	FVSI	LQP	VCPI(P)	VCPI(L)
Q10	9-10	0.573	0.590	0.521	0.543	0.543
=0.948	10-11	0.571	0.588	0.501	0.543	0.542
Q11	6-11	0.781	0.831	0.684	0.734	0.734
=0.857	10-11	0.628	0.669	0.566	0.606	0.606
Q14	9-14	0.900	0.968	0.815	0.873	0.873
=0.7283	13-14	0.858	0.922	0.761	0.825	0.825

In the meanwhile, the line stability indices can also be used to identify the weakest bus in the weakest bus in the system by considering the maximum permissible load at the particular bus.

By referring to Fig. 9, the buses 10, 11 and 14 indicated 94.80 MVar, 85.47 MVar and 72.83 MVar as the maximum permissible of reactive load respectively in IEEE 14 bus test system.

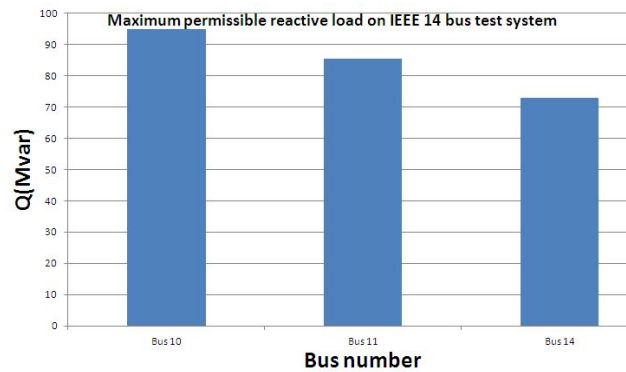

Fig. 9 Maximum permissible reactive load on IEEE 14 bus test system

Therefore, the bus 14 has the smallest maximum loadability; it is considered to be the most critical unstable bus because this bus sustains the lowest load in IEEE 14 bus test system.

V. CONCLUSION

The simulation results of IEEE 14 bus test system demonstrated the feasibility and effectiveness of the line stability indices. These indices were used to determine the critical line referred to a bus and at the same time revealed the weakest bus of a power system. The simulation results show that bus 14 is considered to be the weakest bus for the IEEE 14 bus test system. Verification and comparison were performed by using Lmn, FVSI, LQP, VCPI (P) and VCPI (L). FVSI index demonstrated the value closed to 1, by following with Lmn index, VCPI (P), VCPI (L) and lastly is LQP index. Thus, these indices showed the close agreement and are comparable as an early-warning tool to voltage collapse. These indices are very useful to the power system operators in order to maintain the power system in stable

mode.

ACKNOWLEDGMENT

The authors would like to thank the Ministry of Education, Malaysia (MOE) and Ministry of Science, Technology and Innovation, Malaysia (MOSTI), and the Office for Research, Innovation, Commercialization, Consultancy Management (ORICC), Universiti Tun Hussein Onn Malaysia (UTHM) for financially supporting this research under FRGS grant No. 1417 and the Science Fund grant No.S023.

REFERENCES

- [1] E. E. Sauma and S. S. Oren, "Economic criteria for planning transmission investment in restructured electricity markets," *IEEE Transactions on Power Systems*, vol. 22, pp. 1394-1405, 2007.
- [2] P. Pourbeik, P. S. Kundur, and C. W. Taylor, "The anatomy of a power grid blackout-root causes and dynamics of recent major blackouts," *IEEE Power and Energy Magazine*, vol. 4, pp. 22-29, 2006.
- [3] G. Andersson, P. Donalek, R. Farmer, N. Hatziargyriou, I. Kamwa, P. Kundur, N. Martins, J. Paserba, P. Pourbeik, J. Sanchez-Gasca, R. Schulz, A. Stankovic, C. Taylor, and V. Vittal, "Causes of the 2003 major grid blackouts in north america and europe, and recommended means to improve system dynamic performance," *IEEE Transactions on Power Systems*, vol. 20, pp. 1922-1928, 2005.
- [4] S. Larsson and E. Ek, "The black-out in southern sweden and eastern denmark, September 23, 2003," 2004.
- [5] A. Berizzi, "The Italian 2003 blackout," in *Power Engineering Society General Meeting*, 2004. IEEE, 2004, pp. 1673-1679.
- [6] S. Corsi and C. Sabelli, "General blackout in Italy sunday September 28, 2003, H. 03: 28: 00," in *Power Engineering Society General Meeting*, 2004. IEEE, 2004, pp. 1691-1702.
- [7] H. H. Goh, Q. S. Chua, S. W. Lee, B. C. Kok, K. C. Goh, and K. T. K. Teo, "Power stability monitoring based on voltage instability prediction approach through wide area system," *American Journal of Applied Sciences*, vol. 11, pp. 717-737, 2014.
- [8] P. Kundur, N. J. Balu, and M. G. Lauby, *Power system stability and control* vol. 7: McGraw-hill New York, 1994.
- [9] H. H. Goh, C. W. Tai, Q. S. Chua, S. W. Lee, B. C. Kok, K. C. Goh, and K. T. K. Teo, "Comparative study of different kalman filter implementations in power system stability," *American Journal of Applied Sciences*, vol. 11, pp. 1379-1390, 2014.
- [10] V. Ajarapu and A. P. S. Meliopoulos, "Preventing voltage collapse with protection systems that incorporate optimal reactive power control," *Power Systems Engineering Research Center, Arizona State University* 2008.
- [11] K. Meah and A. H. M. Sadrul Ula, "Simulation study of the cigre hvdc benchmark model with the wsc nine-bus power system network," in *Power Systems Conference and Exposition, 2009. PSCE '09. IEEE/PES*, pp. 1-5, 2009.
- [12] C. Reis and F. M. Barbosa, "A comparison of voltage stability indices," in *Electrotechnical Conference, 2006. MELECON 2006. IEEE Mediterranean*, pp. 1007-1010, 2006.
- [13] G. K. Morison, B. Gao, and P. Kundur, "Voltage stability analysis using static and dynamic Approaches," *IEEE Transactions on Power Systems*, vol. 8, pp. 1159-1171, 1993.
- [14] L. Warland, "A voltage instability predictor using local area measurements," 2002.
- [15] Y. N. N. Tchokonte, "Real-time identification and monitoring of the voltage stability margin in electric power transmission systems using synchronized phasor measurements," PhD, Faculty of Electrical Engineering and Computer Science, University of Kassel, 2009.
- [16] B. Gao, G. K. Morison, and P. Kundur, "Voltage stability evaluation using modal analysis," *IEEE Transactions on Power Systems*, vol. 7, pp. 1529-1542, 1992.
- [17] F. D. Gallana and Z.-C. Zeng, "Analysis of the load flow behaviour near a jacobian singularity," *Power Systems, IEEE Transactions on Power Systems*, vol. 7, pp. 1362-1369, 1992.
- [18] N. Flatabo, R. Ognedal, and T. Carlsen, "Voltage stability condition in a power transmission system calculated by sensitivity methods," *IEEE Transactions on Power Systems*, vol. 5, pp. 1286-1293, 1990.
- [19] I. Musirin and T. A. Rahman, "Novel fast voltage stability index (Fvsi) for voltage stability analysis in power transmission system," in *Research and Development, Student Conference on SCOREd 2002*, pp. 265-268, 2002.
- [20] M. Moghavvemi and F. M. Omar, "Technique for contingency monitoring and voltage collapse prediction," *IEE Proceedings on Generation, Transmission and Distribution*, vol. 145, pp. 634-640, 1998.
- [21] C. Reis, A. Andrade, and F. Maciel, "Line stability indices for voltage collapse prediction," in *Power Engineering, Energy and Electrical Drives, 2009. POWERENG'09*, pp. 239-243, 2009.
- [22] A. Mohamed, G. Jasmon, and S. Yusoff, "A static voltage collapse indicator using line stability factors," *Journal of Industrial Technology*, vol. 7, pp. 73-85, 1989.
- [23] M. Moghavvemi and O. Faruque, "Real-time contingency evaluation and ranking technique," *IEE Proceedings Generation, Transmission and Distribution*, vol. 145, pp. 517-524, 1998.
- [24] P. Kundur, J. Paserba, V. Ajarapu, G. Andersson, A. Bose, C. Canizares, N. Hatziargyriou, D. Hill, A. Stankovic, and C. Taylor, "Definition and classification of power system stability ieee/cigre joint task force on stability terms and definitions," *IEEE Transactions on Power Systems*, vol. 19, pp. 1387-1401, 2004.
- [25] T. Van Cutsem and C. Vournas, *Voltage stability of electric power systems* vol. 441: Springer, 1998.
- [26] P.-A. Lof, G. Andersson, and D. Hill, "Voltage stability indices for stressed power systems," *IEEE Transactions on Power Systems*, vol. 8, pp. 326-335, 1993.
- [27] F. Karbalaee, H. Soleymani, and S. Afsharnia, "A comparison of voltage collapse proximity indicators," in *IPEC, 2010 Conference Proceedings*, pp. 429-432, 2010.
- [28] G. Yanfeng, N. Schulz, and A. Guzman, "Synchronphasor-based real-time voltage stability index," in *Power Systems Conference and Exposition, 2006. PSCE '06. 2006 IEEE PES*, pp. 1029-1036, 2006.
- [29] I. Musirin and T. A. Rahman, "Estimating maximum loadability for weak bus identification using fvsi," *IEEE Power Engineering Review*, vol. 22, pp. 50-52, 2002.