

Coverage and Capacity Performance Degradation on a Co-Located Network Involving CDMA2000 and WCDMA @ 1.9GH

O. C. Nosiri, V. E. Idigo, C. O. Ohaneme, K. A. Akpado

Abstract—Coverage and capacity performance in a cellular network determines the system potentials. If the coverage radius is limited, end users suffer poor service quality, if the system capacity reduces, fewer subscribers will be accommodated. This paper investigated the performance effects of the noise rise caused by the spurious emission from a co-located jammer involving downlink frequency of CDMA2000 and uplink frequency of WCDMA operating at 1.9GHz. Measurements were carried out to evaluate the impact on the coverage radius and the system capacity.

Keywords—Capacity, Co-location, Coverage, Noise rise.

I. INTRODUCTION

COMMUNICATION technologies are confronted with various interference challenges which the network operators must adopt strategies to minimize. The rapid increase in the number of mobile subscribers due to the affordable nature of mobile phones necessitated the need for more base stations to enhance better coverage and improved quality service delivery. The desire by the network operators to establish more base stations was further driven by the need to provide coverage to a geographic region where the service provider has not previously served; to allow for the reuse of channels or spectrum bandwidth to support a larger number of customers and to meet the higher speed requirements of emerging technologies [1]. The drive to meet these requirements led to proliferation of new cell towers which are characterized by its expensive nature; pose environmental health hazards and distorts the beauty of the environment.

A co-location strategy was introduced by the Nigerian National Telecommunication Regulatory Body; The National Communication Commission (NCC) to achieve the outlined objectives: [2], [3].

- Optimize savings and efficient utilization of capital and operational expenditure for site infrastructure development and to achieve improved network coverage and capacity.
- Ensure that incessant duplication of infrastructure is minimized to facilitate sharing thereby maximizing the use of network facilities.

O. C. Nosiri is with the Federal University of Technology, Owerri, Nigeria (phone: +2348033761852; e-mail: buchinosiri@gmail.com).

V. E. Idigo, C.O. Ohaneme, and K.A. Akpado are with Nnamdi Azikiwe University, Awka, Nigeria (e-mail: vicugoo@yahoo.com, co.ohaneme@unizik.edu.ng, kenakpado@yahoo.com).

This work was supported by research grant from TETFUND

- Promote fair competition through equal access granted to the installations and facilities of operators on mutually agreed terms.
- Ensure that new projects and developments should be catered for the unserved and the underserved areas in line with the national communication commission's policy.

Sequel to these needs and developments, new operators seeking to expand their services in the city by building new cell sites are besieged and managed by the licensed service vendors for rent of cell sites and the infrastructure sharing in the country [4], [5]. The drive in this co-location reform though has lots of future benefits to the industry; pose quality service challenges to the network operators. This occurs when a very strong off channel transmitter noise signal appears at the input of a receiver in a co-located setting; it reduces the sensitivity of the receiver with a rise in the total noise floor depending on the degree of the transmitter noise. This also could reduce the utilization capacity and the coverage radius, disfranchising the end users from enjoying their hard paid services. This paper primarily focused on the effects of noise rise caused by spurious emission on network coverage and system capacity.

II. METHODOLOGY

An essential consideration when studying a co-located network primarily requires frequency band analysis between the networks of interest. This is to evaluate whether the frequencies of the networks are adjacent or overlaps. Figs. 1 and 2 show the intended frequency bands of downlink CDMA2000 and uplink WCDMA networks and the likelihood of interference occurrence.

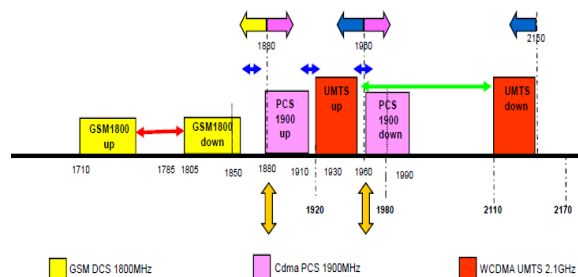

Fig. 1 Intended frequency band

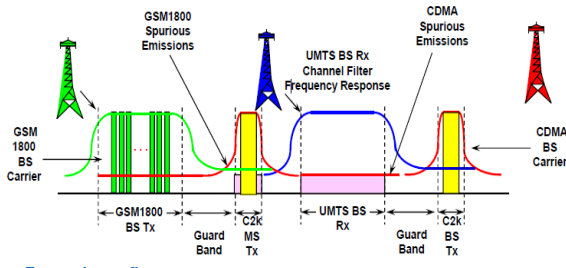

Fig. 2 Interference overview

Fig. 3 shows the spectrum allocation by the International Telecommunication Union (ITU) [6]. The frequency band allocation for CDMA 2000 downlink is between 1930-1990MHz and that of WCDMA uplink is between 1920-1980. The figure shows that CDMA downlink frequency overlaps with the WCDMA uplink frequency by 50MHz, therefore, the CDMA 2000 Tx will interfere UMTS Bs Rx. Considering the great impact of the interference between the two networks if co-located, the regulatory body (NCC), rebanded the frequency between these two networks as shown in Fig. 4. Therefore, CDMA 2000 downlink new frequency band is between 1960-1990. From the figure, the PCS Tx band overlaps 20MHz on WCDMA Rx band. There is no interference between UMTS Bs Tx and CDMA 2000 Bs Rx because of wide frequency isolation band. Refer to Table I.

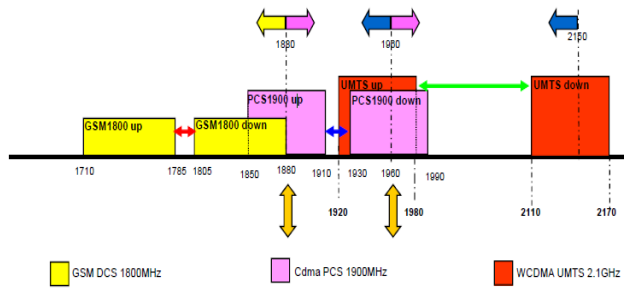

Fig. 3 Spectrum allocation by ITU

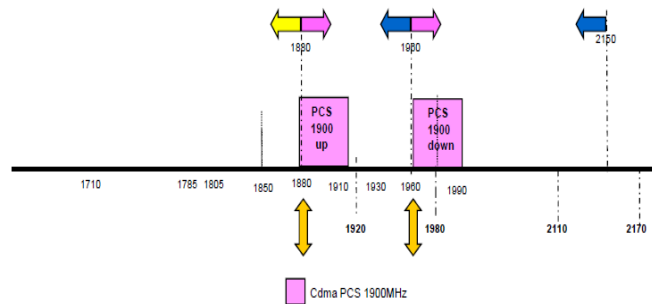

Fig. 4 Spectrum Allocation by NCC (After Rebanding)

TABLE I
FREQUENCY SPECTRUM ALLOCATION

Wireless access technology	Mobile station transmitter (Uplink) (MHz)	Base station Transmitter (downlink) (MH)	Duplex separation (MHz)
CDMA 2000	1850-1910	1930-1990	80
WCDMA	1920-1980	2110-2170	190

It becomes necessary to establish the significant impacts of noise rise on the system coverage radius. To obtain this, a link budget of WCDMA system was conducted on the user equipment. The analysis was carried out so as to determine the connectivity of user equipment (UE). A drive test was conducted using the following instruments: Laptop, UE (Sony Ericsson Z750i), GPS (Globalsat GPS BU-353).

A NetTek analyzer and YBT250 equipment were also utilized in the measurement. The analyzer was connected to the WCDMA sectors under test to measure the received total wideband power (RTWP) at different transmitting intervals of the interfering CDMA system. Table II shows the site parameters and Fig. 5 shows the map of the site measured.

TABLE II
SITE PARAMETERS

Site Name	Cell ID	PSC	Antenna Height	Azimuth
UORL001	UORL001_SI	0	22	100
UORL001	UORL001_S2	8	22	220
UORL001	UORL001_S3	16	22	340
UORL002	UORL002_SI	24	24	90
UORL002	UORL002_S2	32	24	220
UORL002	UORL002_SI	40	24	330

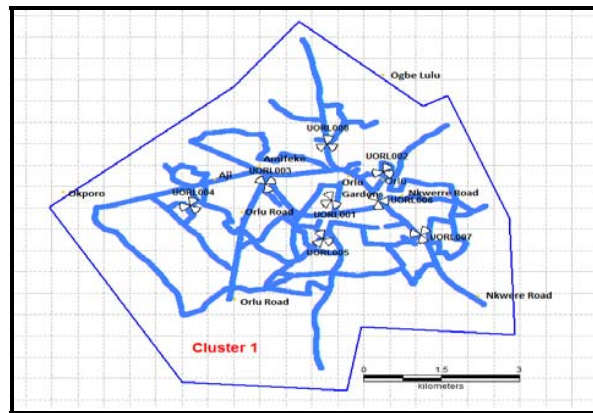

Fig. 5 Map showing the measured site

To analyze the measured received data, certain parameters of importance were calculated by using (1) and (2). These include; the Noise rise (NR) and load factor (η_{UL}). Noise rise is the ratio of the real value of the received total wideband power (RTWP) to the real value of reference noise power expressed in dB, while load factor predicts the rise in background noise due to interference in a radio system.

$$NR(dB) = 10 \log_{10} \left(\frac{P_{rv}}{P_{fn}} \right) \tag{1}$$

where P_{rv} and P_{fv} are real values of RTWP and reference noise power respectively. The expression between the load factor (η_{UL}) and Noise rise(NR) is shown in (2).

$$NR = \frac{1}{1 - \eta_{UL}} \quad (2)$$

A. Analysis of Spurious Impact on Coverage

WCDMA system is interference limited; therefore, system parameter like coverage is greatly impacted by spurious emission. Cell coverage of a system reduces when there is higher load factor of utilization. The uplink capacity is seriously affected due to noise rise caused by loading from spurious. A link budget analysis on the WCDMA system was conducted to determine the connectivity of user equipment. The system loading ought to be managed such that noise rise, including all fluctuations due to offered traffic density variation is kept within the original designed bound. Equation (3) was used to evaluate the uplink path loss on the WCDMA system.

$$L_{path} = P_{UE} - R_{sen} - NR - LNF_{marg} - PC_{marg} - BL - G_{ant} - L_{f+j} \quad (3)$$

L_{path} is the uplink path loss: P_{UE} is the UE output power: R_{sen} is the receiver sensitivity: NR is the noise rise: LNF_{marg} is the log-normal fading margin: PC_{marg} is the power control margin: BL is the body loss: G_{ant} is the sum of the receiver antenna gain and UE antenna gain: L_{f+j} is the loss in feeder and jumpers (neglected). The Wolfish-Ikegami model in equation 4 was considered which gave better approximate cell coverage radius from the typical urban area.

$$L_{path} = 155.3 + 38 \log R - 18 \log(H_b - 17)(dB) \quad (4)$$

where the coverage radius $R = 10^\alpha$,

Hence,

$$\alpha = [L_{path} - 155.3 + 18 \log(H_b - 17)] / 38 \quad (5)$$

The L_{path} , α and coverage radius(R) at different levels of the noise rise were obtained.

B. Analysis of Spurious Impact on Capacity

Providing capacity to keep pace with the explosive growth in wireless data services is a highly complex task due to varying terrain and nature of offered traffic. This poses one of the significant issues of concern during cell planning. If not checked and properly mitigated, severely compromises capacity, consuming the design margin intended to accommodate variations in traffic due to user equipment (UE) loading.

The capacity of a WCDMA was calculated using load equation refer to (6), the uplink load factor is due to the number of subscribers using the system.

$$\eta_{UL} = \frac{E_b}{N_o} \frac{NV(1+i)R}{W} \quad (6)$$

The number of users that correspond to specific loading factor was computed by using (7).

$$N = \frac{W\eta_{UL}}{R} [V(1+i) \frac{E_b}{N_o}]^{-1} \quad (7)$$

η_{UL} is the loading factor due to noise rise: N is the number of users: V is the activity factor of user at the physical layer: W is the chip rate of WCDMA: R is the bit rate of the user. It is obvious that the number of users decreases proportionately with loading. However, as the system is oblivious of spurious emission level from an interfering network, the system's capacity intended for legitimate users will be suppressed.

III. RESULT AND DISCUSSION

Table III shows the summary of the performance results obtained from the analysis. Corresponding graphical representations on the impact of noise rise on the system capacity and coverage were clearly shown in Figs. 6 to 8. If the noise rise level increases to 2dB due to spurious, it signifies 15 subscribers have been cut off with about 33% capacity reduction. But this increase does not signify user loading rather it is due to spurious. This change shows the level of capacity degradation which would have been utilized by subscribers. The linear degradation of coverage at early stage of Fig. 7 suggests degradation basically due to user equipment loading of the system. This corresponds to 75% loading at 6dB noise rise shown in Fig. 6.

TABLE III
OBTAINED COVERAGE AND CAPACITY DEGRADATION DUE TO NOISE RISE

Noise Rise (dB)	L_{path} (dB)	% Load Factor	Coverage Radius (km)	% Coverage Degradation	Reduction in No. of users	% Capacity Reduction
1	151.6	20	2.70	5.9	9	20
2	150.6	37	2.54	11.5	15	33
3	149.6	50	2.39	16.7	21	46
4	148.6	60	2.25	21.4	27	60
6	147.6	75	2.12	30.4	33	73
12	145.6	94	1.88	51.5	42	93
18	139.6	98	1.31	66.5	44	97
22	133.6	99.3	0.91	70.4	45	100
26	131.6	99.5	0.80	79.3	45	100
32	125.6	99.9	0.56	85.6	45	100

The presence of the interfering power from the co-located jammer significantly reduces the receiver sensitivity with increase in noise floor other than the original thermal noise level. This impact give negative effect on the system performance. It is therefore important to study the system loading to ensure that all distortions are controlled within the

original design bounds if the site coverage area and capacity must be maintained.

IV. CONCLUSION

Detailed performance effects of the spurious emission on the noise rise, network coverage radius and channel capacity were clearly evaluated. The results obtained showed that as the spurious from the interfering system increases, the noise level increases thereby causing the degradation to be random. This implies that as noise level rises, the cell radius decreases causing users who are within the degraded radius area to be out of service. This interference challenge can be mitigated by the combination of antenna isolation technique and application of filters or the use of adaptive noise cancellation technique depending on the characteristics of the signal.

REFERENCES

- [1] O. M. SadiqA.O. Oyelade and C.A. Ukachukwu, "Ten years of telecommunication infrastructure development in Nigeria", international conference on innovation in engineering and technology, August 8-10, 2011.
- [2] A. C. Louay, E. Bahjat, H. Ghassan, and M. Mohamad, "Telecom Infrastructure Sharing: Regulatory Enablers and Economic Benefits," Booz Allen Hamilton, 2007.
- [3] S. Opara, I. Ituen, "An option for Telecom operators during recession". A journal paper, pp 1-2, 2009.
- [4] Nigerian Communication Week, the Treat of Multiple Regulations in Telecommunication. Page 1, Mon, 08, 2012.
- [5] NCC "Guidelines on Collocation and Infrastructure Sharing' Nigerian Communications Commission, pp.1-13, 2002.
- [6] C. Xinting, "Analysis on co-site interference between different Mobile Communication system, wireless technical support department, Huawei Technologies Co. Ltd, p 9, 2008.

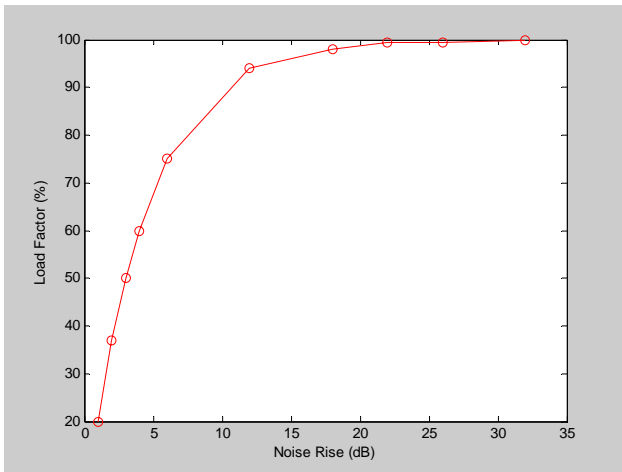

Fig. 6 Noise rise and the uplink load factor due to spurious

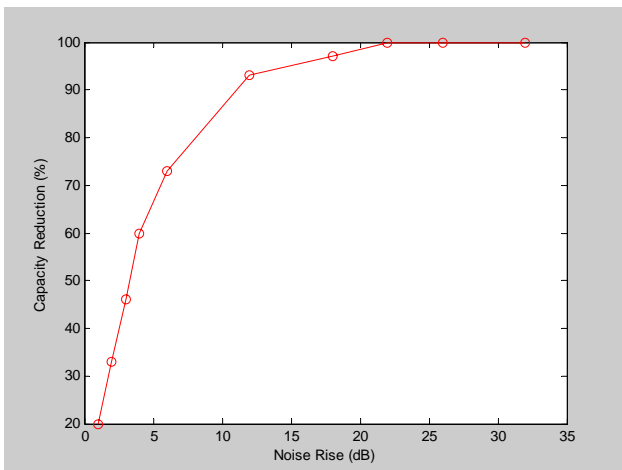

Fig. 7 Effect of Noise rise on the coverage performance

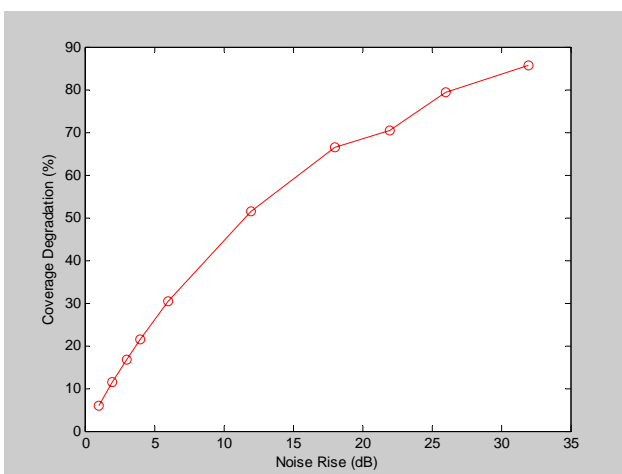

Fig. 8 Capacity degradation performance due to spurious emission