

Design of Seismically Resistant Tree-Branching Steel Frames Using Theory and Design Guides for Eccentrically Braced Frames

R. Gary Black, Abolhassan Astaneh-Asl

Abstract—The International Building Code (IBC) and the California Building Code (CBC) both recognize four basic types of steel seismic resistant frames; moment frames, concentrically braced frames, shear walls and eccentrically braced frames. Based on specified geometries and detailing, the seismic performance of these steel frames is well understood. In 2011, the authors designed an innovative steel braced frame system with tapering members in the general shape of a branching tree as a seismic retrofit solution to an existing four story “lift-slab” building. Located in the seismically active San Francisco Bay Area of California, a frame of this configuration, not covered by the governing codes, would typically require model or full scale testing to obtain jurisdiction approval. This paper describes how the theories, protocols, and code requirements of eccentrically braced frames (EBFs) were employed to satisfy the 2009 International Building Code (IBC) and the 2010 California Building Code (CBC) for seismically resistant steel frames and permit construction of these nonconforming geometries.

Keywords—Eccentrically Braced Frame, Lift Slab Construction, Seismic Retrofit, Shear Link, Steel Design.

I. INTRODUCTION

THE Tioga building, located in downtown Berkeley California, was constructed in 1954 using the lift slab construction method pioneered and patented by Tom Slick. The slabs were poured on the ground in two units, lifted into place with metal collars cast into the slab and positioned around pre-erected hollow steel section columns. The erected slabs were later tied together by a poured-in-place concrete core which provided lateral resistance. Fig. 1 is a rendering of the retrofitted building and Fig. 2 depicts an original plan with the two slabs, columns, and concrete core labeled accordingly.

In total, the building offers over 3700 square meters (40,000 square feet) of leasable space in a prime commercial district of downtown Berkeley.

A structural evaluation of the building from 1989, established that the anticipated seismic performance was not in compliance with contemporary codes, thus preventing any major potential tenants from leasing space in the building. Beyond code deficiency, the building suffered from a public image problem.

R. G. Black is a Professor of Architecture at the University of California, Berkeley and a licensed Professional Engineer in California (e-mail: gary@integratedstructures.com).

H. Astaneh-Asl is a Professor of Engineering at the University of California, Berkeley and a licensed Professional Engineer in California.



Fig. 1 Rendering of the Tioga Building, 2013

The cantilevered slabs, which were part of the original design to reduce slab moments, had suffered from creep deformations, which were visible from the public way. The sagging slabs created the image of a poorly constructed and unsafe building.

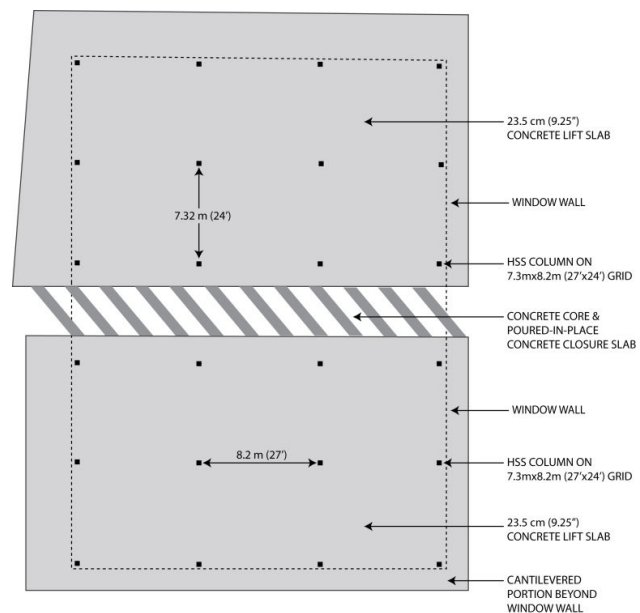

Fig. 2 Plan showing the slabs, columns and concrete core

Furthermore, the collapse of a sixteen story lift-slab in Bridgeport, Connecticut (USA) in 1987, which killed 28

construction workers and ultimately put an end to lift-slab construction [1], caused concern among Berkeley's building code enforcement officials.

Although previous structural reviews found the building in compliance with 1954 seismic force levels and therefore exempt from a mandatory seismic retrofit, its history and negative public perception made the building virtually un-leasable to anyone, public or private. Thus, the building was planned for a renovation and seismic retrofit that would change public opinion and bring the building into compliance with the seismic safety standards of the current design codes [2]-[4].

Such a retrofit would necessarily be highly visible and provide an undeniable image of seismic strengthening. The existing concrete core was ductile by code provisions, but it provided only half of the required seismic capacity. Further, the location of the core and associated shear walls allowed for global torsion. While strengthening the core was a possible solution, it would be expensive, would not address global torsion, and would not help change public perception.

To attend to the seismic deficiencies *and* the owner's request for a public statement the best solution would be to place steel frames around the perimeter where they would be most effective at reducing torsion and would be seen by the public.

II. ARGUMENTS FOR A BRANCHING TREE GEOMETRY

The branching tree geometry depicted in Fig. 1 is not only visually striking, but also adheres to strict structural principles and constructability rationale. With four equally sized floors of equal mass spaced 3.05 meters (ten feet) apart, the vertical distribution of seismic force is an inverted triangle with 40% of the seismic load applied at the uppermost (roof) diaphragm, diminishing to 10% at the second floor diaphragm.

The branching tree geometry reaches across three (3) bays and has eight (8) contact points with the roof diaphragm. At the fourth floor it reaches across two (2) bays and has six (6) points of contact. In concert with the force distribution, the frames' reach and points of contact with the diaphragms becomes progressively less as it moves toward the ground. However, the frame members themselves become progressively larger, mirroring the build-up of shear force. By reaching across a larger number of bays and having more contact points with the diaphragms at the upper levels where the vertical distribution of force is greatest, the concentration of drag forces is reduced.

As mentioned earlier, the existing concrete core was capable of resisting half of the 2010 seismic force level and, during schematic structural design, was assigned to do so. The new, steel frames would be designed to resist the remainder. However, achieving this distribution required that the stiffness of the frames be "tuned" to the stiffness of the core.

A 3D computer model was prepared and several frame geometries investigated.

In general, moment frames with the requisite strength capacity were too flexible, while traditional braced frames too stiff. The tree-branching frame's unique ability to resist lateral

displacement through a dual mechanism –both axial and bending stiffness – yields more stiffness options. Working with this geometry that relied on both axial and bending capacity, it was possible to tune the frames' stiffness so that it would share load with the core and also mitigate global torsion.

For these reasons, the overall frame geometry is broad at the top and narrow at the bottom where it contacts the ground mimicking the form of a tree.



Fig. 3 Monterey Cypress

Since it was decided that the frames would be placed along the exterior column lines where the vertical component of the diagonal frame forces could be resisted by the existing columns and where visibility from the public way would be maximized, minimizing the extent of a new foundation became a paramount concern. The existing foundations consist of individual bell shaped piers under each column, and deep footings under the reinforced concrete shear walls of the core. Because any new foundations would intersect the piers and bell footings of the existing columns, decreasing the frame dimensions at the ground would reduce the extent of the new foundations, thus minimizing disruption to the existing piers and bell footings.

III. ACHIEVING CODE COMPLIANCE

The 2010 CBC and the AISC Seismic Provisions recognize four basic steel lateral force resisting systems: moment frames, concentrically braced frames, eccentrically braced frames and steel shear walls. Concentrically braced frames include buckling restrained frames as well. The San Francisco Bay Area is bounded by the San Andreas Fault to the west and the Hayward fault to the east. The Tioga building is located less than 1.6 kilometers (one mile) from the active trace of the Hayward Fault. Based on the credible magnitude and frequency of earthquakes on these faults only Special Moment Resisting Frames (SMRFs), Special Concentrically Braced Frames (SCBFs), Steel Plate Shear Walls (SPSW) and Eccentrically Braced Frames (EBFs) are viable solutions

approved by contemporary codes. Each frame type has an assumed geometry shown in Fig. 4.

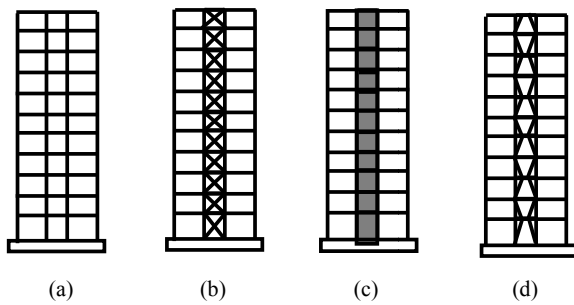

Fig. 4 Typical steel frames: (a) Moment, (b) Concentrically Braced, (c) Steel Plate Shear Wall, (d) Eccentrically Braced

Steel Moment frames are composed of a vertical column and a horizontal beam connected to each other with bolted or welded moment connections. Such frames were deemed too flexible for the retrofit solution.

Concentrically braced frames use vertical columns and horizontal beams with diagonal braces that intersect at a joint. In concentrically braced frames, the bracing member is the main energy dissipating element through buckling in compression and yielding in tension [5]. The bracing member is required by seismic codes to have a prismatic cross section and tapering of the bracing member is not allowed. Thus, it would not be possible to use the theory or design guides for concentrically braced frames for the proposed design because a key feature of the tree-branching frame is the extensive use of tapered members.

The steel shear wall system uses steel plates to resist lateral force. In this case, the steel shear wall system could not be used since the steel plate would block the windows. In addition, the existing system did not have horizontal floor beams to be used as the boundary members of the steel shear wall system.

Eccentrically braced frames use vertical columns, horizontal beams and diagonal braces that form a V or inverted V configuration. The bracing member in this case is designed to remain elastic, while the shear link undergoes inelastic shear deformation during major earthquakes [6], [7]. Because the bracing member remains elastic, it does not require prismatic cross sections. Of the four recognized steel seismic solutions, only the eccentrically braced frame provided a possible solution for the design of a tree-branching frame that used non-prismatic diagonal elements with variable cross sections.

IV. EBF THEORY & CODE DISCUSSION

In eccentrically braced frames, the centerlines of the brace members have some eccentricity with respect to the point of intersection of beams and braces. Dimension "e" in Fig. 5 (a) and (b), below, show this eccentricity for eccentrically braced frames with *horizontal* and *vertical* shear links respectively. The purpose of this eccentricity is to create relatively short elements in the frame, called "shear links," which behave as

inelastic shear fuses during strong earthquakes, while all other components of the frame remain elastic. The shear yielding of the shear links not only protects other elements of the structure from damage, it also provides damping and energy dissipation capacity for the frame to reduce seismic forces and deformations in the structure. Reducing seismic forces results in less material needed to resist such forces and reducing deformations result in reduced damage to structural as well as non-structural elements including walls, partitions, façade, elevator shafts, staircases, and piping and ventilation systems.

Key members of a typical eccentrically braced frame are the (i) shear links, (ii) beams outside the links, (iii) columns and (iv) diagonal braces, shown below.

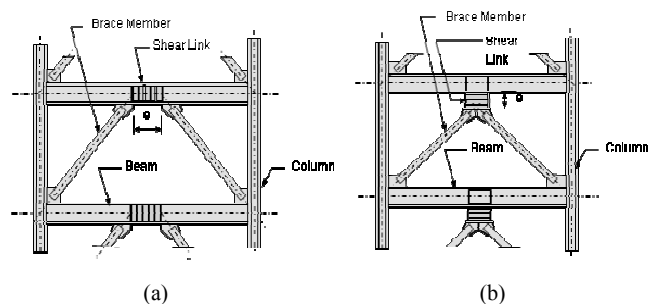

Fig. 5 Typical EBF assemblies: (a) Horizontal Shear Link and (b) Vertical Shear Link

In general, all of these are subjected to some combination of axial load, shear, and bending but as mentioned earlier, only the shear links experience yielding while all other elements remain elastic. The columns can be steel or composite (steel sections filled with concrete or encased in concrete.) The cross section of columns can be rectangular box, pipe or wide flange. Shear links are usually hot-rolled I-shaped sections although the use of I-shape welded built-up sections is also allowed. Braces are generally hot-rolled steel wide flanges or cold-formed round or rectangular box shapes.

Fig.6 shows examples of common configurations of an eccentrically braced frame system where horizontal or vertical shear links are used to resist lateral loads.

Selecting the configuration of an eccentrically braced frame is an important step in the design process. The most important consideration is to ensure that the configuration can accommodate link yielding while all other elements of the system remain elastic. Other considerations include the inelastic cyclic behavior of the links in a particular configuration as well as the rotational demand on the links. Let us consider these issues for configurations shown in Fig 6.

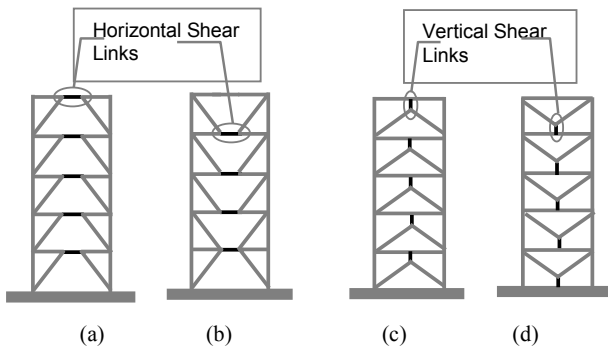

Fig. 6 Typical configuration for horizontal and vertical EBFs

Configurations (a) and (b) in Fig. 6, where shear links are horizontal and located at mid-span of the beams, are very common in new buildings, but, using it as a measure of seismic retrofit in an existing structure can be difficult and costly. The reason for this is that in an existing structure the horizontal beam needs to be specially detailed at its mid-span, where the shear link is located, to ensure that it has sufficient ductility and is seismically compact to undergo the relatively large shear yielding and shear distortions without experiencing local or overall buckling or fracture. In the Tioga building there are no steel beams because it was constructed as a concrete “lift-slab” structure with flat slabs spanning between steel columns. Therefore, use of horizontal shear link geometry was ruled out in favor of a vertical shear link geometry.

Configurations (c) and (d) in Fig. 6, both have vertical shear links. The system shown in Fig. 6 (d) was selected as being the most viable system for the Tioga Building for several reasons. First, the shear links could be fabricated in the shop and installed on the top of each floor, thus making the installation easier. Second, the shear links at the ground floor where the accumulation of seismic force is greatest could be connected directly to the new foundation. To create the horizontal beam, a composite section composed of a T-section, on the bottom of the slab and welded to the HSS columns and a flat steel plate bolted through the slab and T-section was designed. This composite section occurred everywhere that a frame member terminated and wherever a shear link was installed. The flat plate was extended at each floor level over the full length of the building to provide a drag strut to the frames. A typical detail of the assembly is shown below, in Fig. 7.

Some of the advantages of using eccentrically braced frame systems are:

1. Eccentrically braced frames can accommodate doors and windows better than concentrically braced frames.
2. In general, eccentrically braced frame systems are stiff compared to steel shear walls or moment frames, however their stiffness can be controlled to some extent by changing the length of the shear link. Short links result in lateral stiffness's close to that of concentrically braced frames, while long links result in stiffness's closer to that of a moment frame. This feature aided us in adjusting the

stiffness of the “Tree-Branching Braced Frame” system to a desirable value.

3. Eccentrically braced frames are suitable to high seismic applications, consistent with the seismic demands in the San Francisco Bay Area of California. However, eccentrically braced frames are also used to resist wind and less extreme seismic forces.
4. Eccentrically braced frames with short links have relatively high initial elastic stiffness, reducing drift up to the start of yielding in the link. This results in very desirable damage control under *service* wind and earthquake loads.
5. The steel eccentrically braced frame is significantly lighter than reinforced concrete shear walls reducing seismic loads and the forces that have to be carried by the existing columns and foundations.
6. Eccentrically braced frames are usually “all welded systems,” which includes some field welding. With proper detailing of field connections, usually beam-to-column and brace end connections, the use of expensive Demand Critical Complete Joint Penetration welds can be minimized by reserving these for fabrication of the shear links themselves. In the Tioga retrofit this practice was followed.

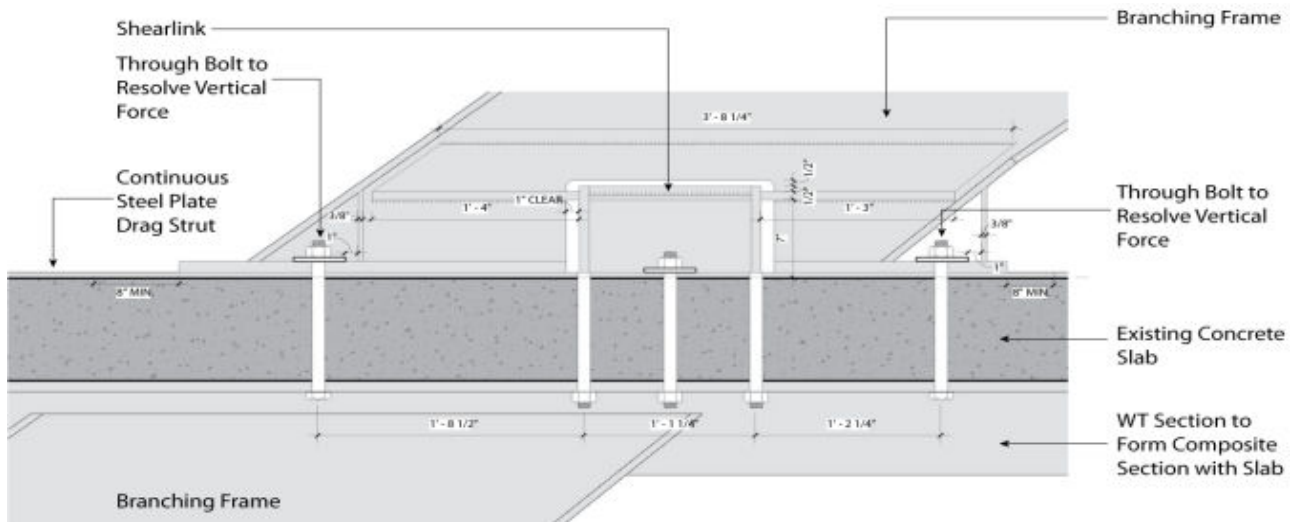

Fig. 7 Typical configurations for horizontal and vertical EBFs

V. CYCLIC BEHAVIOR OF SHEAR LINKS AND EBFs

Figs. 8 (a) and (b) show sample results of shear link tests. Shear forces in the link versus shear deformation is displayed. As can be seen, the behavior is ductile and desirable.

Fig. 9, on the following page, shows sample results of cyclic tests of a three story eccentrically braced frame [8]. The tested specimens showed very desirable behavior and tolerated cyclic drift values up to 0.015 the height of the 3-story frame.

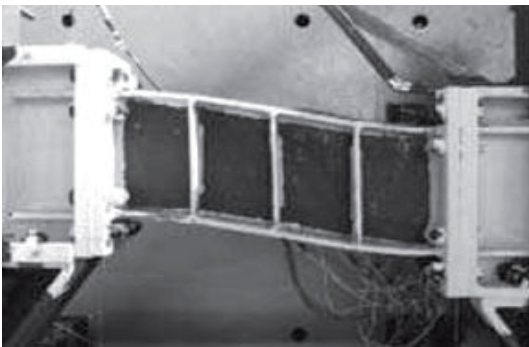

Fig. 8 (a) Shear link specimens after test [8]

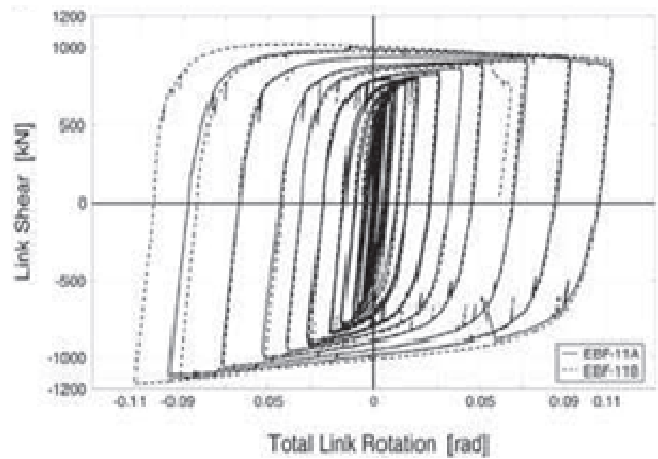

Fig. 8 (b) Link rotation angle versus shear in the link [8]

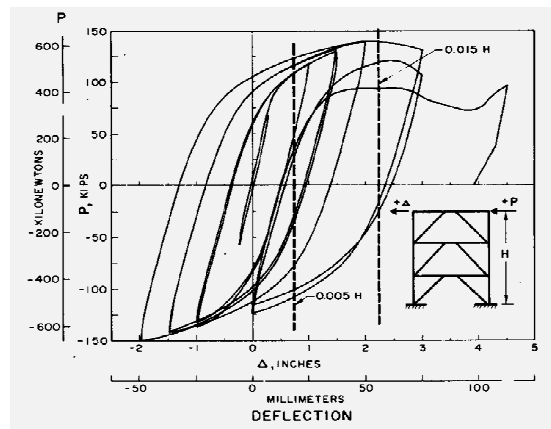

Fig. 9 Cyclic Behavior of an EBF [8]

VI. FRAME DESIGN

Initial work on the frame design focused primarily on geometry –the, positioning, layout, and size of the members

themselves. The goal of this work was to devise a geometry that would integrate the architectural design and the structural performance. Integrating a building's architecture and its structure was a recurring theme in the design of landmark buildings of the past; Chartres Cathedral, Westminster Hall and La Sagrada Familia to name just a few examples. In each of these buildings the structure performed a dual role – it gave structural support and provided the aesthetic rationale for the architecture. With the rise of the modern movement and greater specialization of tasks performed by architects and by engineers, building structures began taking on the singular role of providing support. In many cases, divorced as it was from the architecture, structure became hidden from view. Engineers fell into a subservient support role inventing structures for buildings that probably never should have been constructed in the first place.

With the advent of the modern computer and finite element analysis, however, there is a new-found resurgence in an age old theme of integrating structure and architectural form, Fig. 10.



Fig. 10 Calatrava Bridge

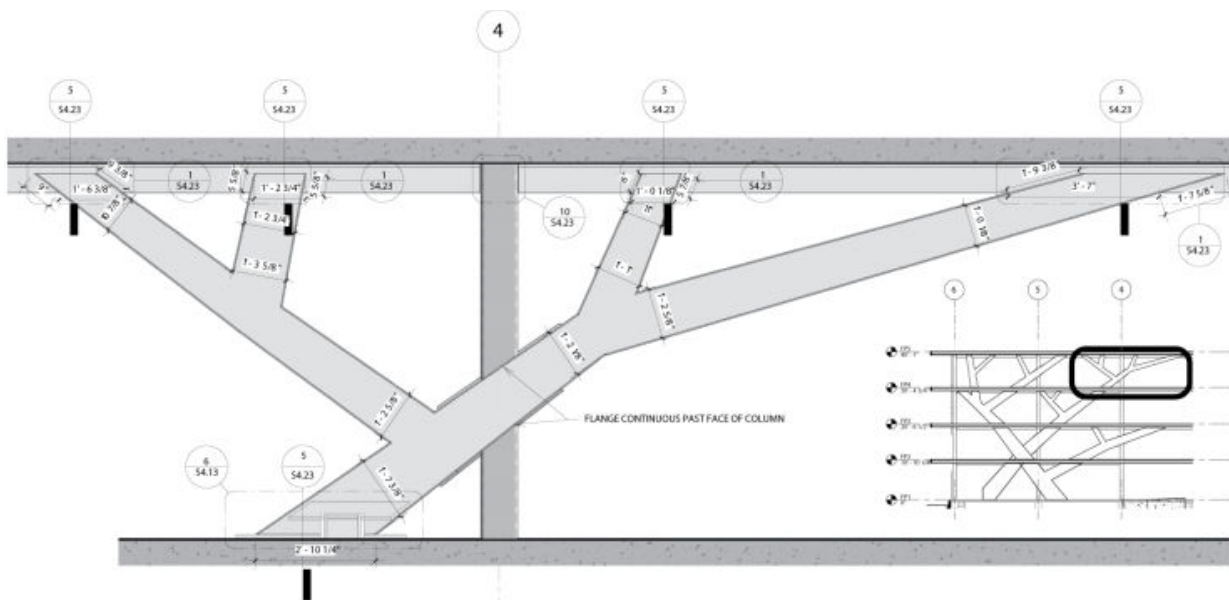

Fig. 11 Computer-aided geometries

Using computer aided finite element analysis, which gives the user immediate feedback regarding structural performance; one can follow an iterative procedure which checks the structural performance against the architectural form [9]. Armed with real time information *both* the structural solution and the architectural form can be modified to achieve desired goals. In the Tioga frames the structural goals were to (i) provide additional seismic strength and stiffness, (ii) share seismic forces with an existing concrete core, and (iii) reduce global torsion to within acceptable code limits. The architectural goals were to provide a seismic frame that would be visible from the street and unique enough to be immediately recognizable. The architectural intention was to change the public's perception of the building and make it a

desirable landmark to move into. An added benefit of the proposed solution was that the retrofitted building would also be one of the most seismically resistant structures in the area.

To design the frame and accomplish the above goals we built a three dimensional structural model [10] of the building including the core, slabs and the new proposed steel frames. Simultaneously, we constructed a three dimensional architectural model of the building to assess visual efficacy from important view corridors. Using an iterative approach, assisted by an excel spread sheet that checked moment, shear and axial stresses, we were able to "grow" the tree branching frames depicted in Figs. 11 and 12, and earlier in Fig. 1.

The shear links were not included in these early designs. However, all frame members were sized to remain elastic. To

account for the limited availability of standard wide flange sections, over-strength factors, and strain hardening of the shear links, the combined stresses in each frame member were kept under seventy percent of factored yield values. This was an important decision, because if a selected shear link generated inelastic stresses in any single frame member the entire geometry might have to be re-designed to maintain proper overall proportions.

With the frame geometry determined, the next step was to design a shear link, which would be located at the base of each member or member group, Fig. 12.

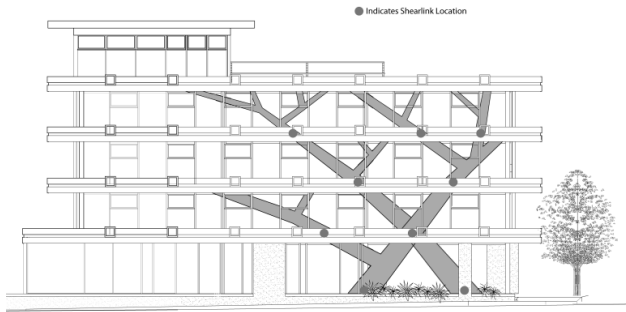

Fig. 12 Frame with shear link locations identified

A critical issue of the design was developing a strategy to resolve the vertical force component generated by the eccentricity itself.

In the standard eccentric frame depicted in Fig. 6, the vertical component at the shear link is cancelled by the braces, one of which is in tension and the other in compression. In the tree-branching design, this symmetry doesn't exist, mandating that the vertical component be resolved, leaving the shear link free to dissipate the seismic forces through inelastic shear *only*. The following general procedure was used as a guideline.

At the start of the procedure, three global reactions at the base of each member were known from the final SAP runs: F_1 , F_3 and M . F_1 represents the shear force parallel to the slab; F_3 the vertical force oriented perpendicular to the slab; and M represents the global bending moment at the base of the frame member itself.

To ensure that the shear link resists only force F_1 , the vertical components, F_3 and M are resisted by bolts that pass through the composite slab, T-section and plate, as shown in Fig. 7. The connection of the frame member to the slab is designed using Teflon pads and slotted holes to ensure that the frame will slide horizontally and load the shear link with the full force of F_1 . Wide flange selection was based on the demand shear (V_{demand}), which in every case is equal to (F_1).

The following AISC 341[3] general procedure was used as a guideline for selecting a properly dimensioned shear link, based on the global frame forces.

Using the AISC equations (1) and (2) below leads to a trial section:

$$A_w = \frac{V_{demand}}{0.6\phi F_y} \quad (1)$$

$$\text{where } A_w = (d - 2t_f) \quad (2)$$

From (1) and (2) a trial section is selected based on the required web area (A_w) to resist shear. Then,

$$V_u \leq \phi V_n \quad (3)$$

$$V_n = \text{smaller of } V_p \text{ or } \frac{2M_p}{e} \quad (4)$$

where V_u is shear demand, ϕV_n is the shear capacity modified with by reduction factor, ϕ ; V_p is the plastic shear capacity; M_p is the plastic moment capacity and e is the EBF link length; which for the current design problem always results in:

$$V_n = V_p \quad (5)$$

From which we find an expected shear:

$$V_{expected} = 1.25R_y V_n \quad (6)$$

where R_y is the ratio of the expected yield stress to the specified minimum yield stress, F_y . A ratio greater than 1 results from:

$$V_{expected}/V_{demand} \quad (7)$$

The frame members' geometry plus its connections must remain elastic with the following forces:

$$F_{1,expected} = F_1 V_{expected}/V_{demand} \quad (8)$$

$$F_{3,expected} = F_3 V_{expected}/V_{demand} \quad (9)$$

$$M_{expected} = M \times V_{expected}/V_{demand} \quad (10)$$

$$P_{expected} = P \times V_{expected}/V_{demand} \quad (11)$$

$$V_{expected} = V \times V_{expected}/V_{demand} \quad (12)$$

To determine the height of the shear link (h) we used the following procedure:

$$\Delta_{elastic} = \text{displacement from SAP analysis} \quad (13)$$

The deflection amplification factor, C_d is taken from ASCE 7. Then,

$$\Delta_{expected} = \Delta_{elastic} \times \frac{C_d}{I} \quad (14)$$

where I , the importance factor, for this occupancy category is 1.0.

The maximum allowable rotation angle, ϕ_r , is 0.08 radians:

$$\phi_r = \frac{\Delta_{\text{expected}}}{h} \quad (15)$$

where h is the height of the shearlink.

Solving for h :

$$h = \frac{\Delta_{\text{expected}}}{0.08} \quad (16)$$

At the conclusion of the above procedure a wide flange section will have been selected and the height will be known. And the corresponding tree-branching frame member or member group will have been checked for elastic response. A typical finished shear link and frame group is shown, below, in Figs. 13 and 14.



Fig. 13 Photo of constructed shearlink



Fig. 14 Photo of frame under construction

VII. CONCLUSION

Using the design protocol for eccentrically braced frames offers a viable alternative for the design of steel frames whose geometries don't conform to the rigidly held geometries of the standard moment frame, concentrically braced frame and eccentrically braced frames. Using the methods described in this paper and removing the expense and delay associated with full size or model testing opens up the opportunity for a wider array of frame geometries. Theoretically, frame members of any shape could be used; including curved members, tapered

members, and segmented members, as long as they remain elastic throughout the deformation cycles of the shear links. Thus, it becomes possible to engage *both* architects and engineers in the design of steel frames which not only provide superior seismic and wind performance, satisfying the most stringent code requirements, but also begin to integrate the architectural theme and the structural design.

ACKNOWLEDGMENT

The authors would like to acknowledge Rafael Sabelli, SE, Chair of the Seismic Design Manual subcommittee of the American Institute of Steel Construction (AISC), for his role in suggesting that an eccentrically braced frame approach might be a viable way to obtain code approval of the tree branching frame design; Sasha Shamzaad building owner and general contractor who was responsible for approving the project and for constructing it; John Havrilesko, architecture and engineering graduate from UC Berkeley, who spent many hours running multiple structural models and testing various frame configurations to arrive at the one depicted in this paper; Eric Spletzer, architecture and engineering graduate of UC Berkeley who assisted with 'growing the tree' using iterative computer programs; and finally to John Voekel, architecture and engineering graduate from UC Berkeley, who wrote the program to select the most economical shear link, and helped with editing, preparing figures, and formatting the manuscript.

REFERENCES

- [1] D. Kaminetzky, *Design and Construction Failures: Lessons from Forensic Investigations*. New York: McGraw-Hill, pp. 78–85, 1991.
- [2] AISC, *Specifications for Structural Steel Buildings*, American Institute of Steel Construction Inc., Chicago, IL, 2010.
- [3] AISC, *Seismic Provisions for Structural Steel Buildings – ASCE 341*, American Institute of Steel Construction Inc., Chicago, IL, 2010.
- [4] ASCE, *Minimum Design Loads for Buildings and Other Structures – ASCE 7-10*, American Society of Civil Engineering, Reston, VA, 2010.
- [5] E.P. Popov, and R.G. Black, "Steel Struts under Severe Cyclic Loadings." *J. of the Structural Division*, ASCE vol. 107, no ST9, Sept. 1981, pp. 1857-1881.
- [6] J. Malley, and E.P. Popov, "Shear Links in Eccentrically Braced Frames." *J. of Structural Engineering*, ASCE vol. 110, no. 9, Sept. 1984, pp. 2275–2295.
- [7] D.N. Manheim "On the Design of Eccentrically Braced Frames", *Doctoral Dissertation*, University of California, Berkeley, 1982.
- [8] N. Mansour, C. Christopoulos, and R. Tremblay, "Experimental performance of full-scale eccentrically braced frames with replaceable shear links," *Proceedings, STESSA Conference*, Behaviour of Steel Structures in Seismic Areas: STESSA 2006, 5th International Conference on Behavior of Steel Structures in Seismic Areas.
- [9] R.G. Black, "Design of Concrete Tracery Trusses to Define Architectural Space." *J. of Architectural Engineering*, ASCEvol. 1, no 1, March 1995.
- [10] E.L. Wilson. Structural Analysis Program, SAP (Version 14) [Computer software], Computers and Structures, Inc., Berkeley, CA 1963 to 2013.