

Automatic Extraction of Water Bodies Using Whole-R Method

Nikhat Nawaz, S. Srinivasulu, P. Kesava Rao

Abstract—Feature extraction plays an important role in many remote sensing applications. Automatic extraction of water bodies is of great significance in many remote sensing applications like change detection, image retrieval etc. This paper presents a procedure for automatic extraction of water information from remote sensing images. The algorithm uses the relative location of R color component of the chromaticity diagram. This method is then integrated with the effectiveness of the spatial scale transformation of whole method. The whole method is based on water index fitted from spectral library. Experimental results demonstrate the improved accuracy and effectiveness of the integrated method for automatic extraction of water bodies.

Keywords—Chromaticity, Feature Extraction, Remote Sensing, Spectral library, Water Index.

I. INTRODUCTION

INFORMATION extraction is the key step in remote sensing applications, which is used to acquire knowledge from images. This information helps in analysis and decision making in many fields. Remote sensing information extraction establishes a relation between data and the corresponding objects, it extracts the objects physical quantities and its spatial distribution based on geographic models [1].

Water is one of the most important natural factors of land surface system. Hence, its humanistic, accurate and automatic extraction is a challenge. Recently with a certain degree of accuracy many water body extraction algorithms have been proposed. Many researchers rely on existing GIS data or manual digitization to obtain water body boundaries. Some researchers use water's spectral characteristics for automatic water body extraction [2]. Also the physical features of water like shape, texture etc were used for extraction [2], [10].

Further many image segmentation algorithms were developed using neural networks [3]-[5] and also many water indexes were proposed for water body extraction [6]. However these methods led to a deviation in terms of accuracy in practical applications.

Literature presents several techniques for extraction of water bodies. Here, we review some of the works presented in the literature. S. Nandagopalan et al. [11] has presented a method which is a combination of feature extraction methods

Nikhat Nawaz is a research scholar with the Jawaharlal Nehru Technological University, Hyderabad, India (phone: 995-918-8283; e-mail: nik_nawaz@hotmail.com).

S. Srinivasulu, Dr., is with Jawaharlal Nehru Technological University, Hyderabad, India. He is now a professor in the Department of Civil Engineering (e-mail: ss_lu@yahoo.com).

P. Kesava Rao, Dr., is an assistant professor in National Institute of Rural Development, Hyderabad, India (e-mail: author@nrim.go.jp).

like color, texture and edge histogram descriptor with a provision to add new features for better extraction. Waqasrasheed et al. [12] proposed color correlogram for extraction of water bodies. Color correlogram extracts color distribution of pixels as well as the spatial information of pixels in the image. Serkan Kiranyaz et al. [13], [14] have proposed extraction of the object boundaries using canny edge detector. Further a multiscale approach is used where each successive scale provides further simplification of images by removing more details such as texture and noise while preserving major edges. Jennifer J. Ranjani et al. [15]-[17] propose a system which automatically discriminates the objects and the false edges in edge detecting feature extraction.

Objectives of the Work

- The main contribution of the work is proposing a simple R method for extraction of water bodies. The proposed method is based on the relative location of R color component in the chromaticity diagram.
- Further the R method is integrated with the whole method to increase the accuracy of extraction.

The rest of the paper is organized as follows: Section II describes the algorithm of the proposed method. Section III discusses the results in detail and Section IV describes the conclusion, Section V deals with the future enhancements and Section VI shows the references used for this research.

II. EXTRACTION OF WATERBODIES

A. R- Method

The color vision systems are developed based on the study of colors, whose perceptual attributes are brightness, hue and saturation. For a fixed brightness W^* , the symbols R, G, B shows relative locations of the red, green, and blue spectral colors, where any color can be reproduced by mixing an appropriate set of three primary colors R, G, B [6]. Let W_k be the amount of K^{th} primary required to match reference white then the quantities

$$T_k(c) = B_k / W_k, k=1, 2, 3$$

are called tristimulus values of the color C [7]. B_k is the proportions in which the three primaries are mixed to form that color C.

Thus the tristimulus values of a color give the relative amount of primaries required to match that color [7]. Based on the tristimulus values, the chromaticity of a color is defined as

$$t_k = T_k / T_1 + T_2 + T_3; k=1,2,3,\dots$$

and also $t_1 + t_2 + t_3 = 1$; then only two of the three chromaticity coordinates are independent. Chromaticity diagram shows color composition as a function of x(red) and y(green) then corresponding value of z is $z = 1 - (x+y)$ [7].

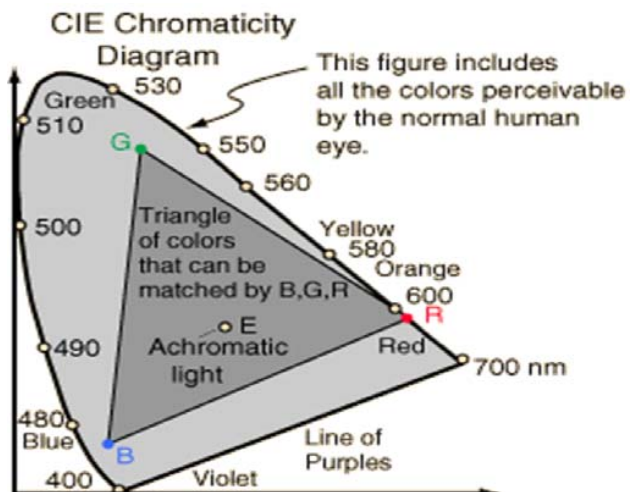

Fig. 1 CIE Chromaticity diagram [9]

Thus the chromaticity diagram clearly suggests that the shades of blue are formed with very less amount of red color. This property of chromaticity is used for extraction of water bodies in the R method.

The steps involved in the extraction of water bodies in the R method proposed in this paper are

- 1) separate given image in R, G & B layers
- 2) take R layer
- 3) check the value of each pixel
- 4) if it is less than 100 it is considered as water body else non water body.

A. Whole Method

Water indexes are developed to enhance water information according to its spectral characteristics. In whole method water index fitted from spectral library using spectral angle method [8] is used. The formulae for water index is [1]

$$SAM = \frac{S \cdot S'}{|S| \cdot |S'|}$$

S is the spectral value of the image, S' is the spectral value in the library. SAM represents the water index computed from spectral angle method. If SAM is less than 0.05 then it is considered as water component, else it is neglected.

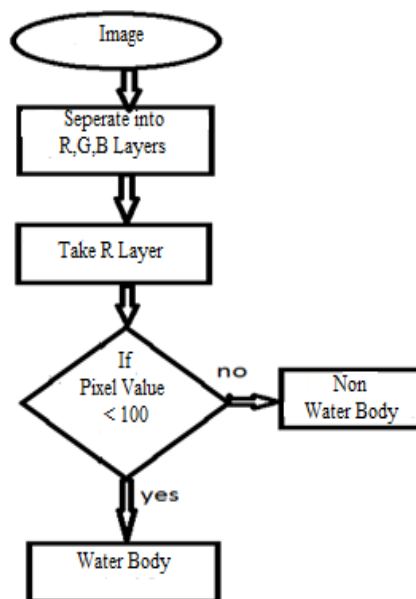

Fig. 2 Flow chart of R method

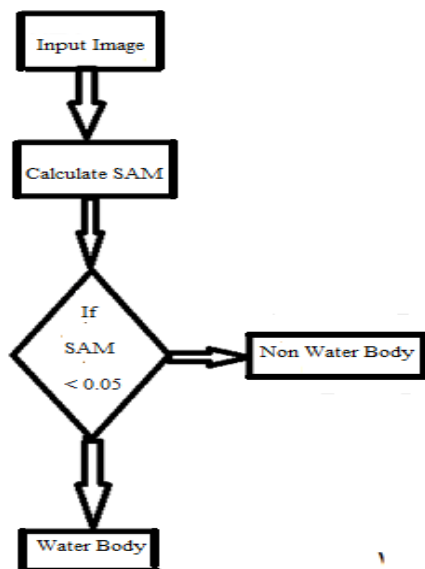

Fig. 3 Flow chart of whole method

B. Integrated Whole-R Method

This paper proposes a new method, which combines R method and the whole method. The integration of these two methods improves the accuracy of extraction.

Implementation:

Given an image

- Apply R method on it first, by separating the image into R, G, B components, take the R component and if the intensity value of pixel in the R component is less than 100, it is a water body.
- Divide the output image of R method into blocks of 15x15 and compute water index for each block using

whole method. This technique filters out the false water bodies obtained in R method.

- If water index is less than 0.05 then there exists a water component else ignore it.

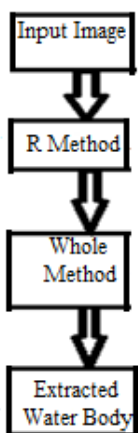

Fig. 4 Flow chart of Whole-R method

III. RESULTS AND DISCUSSIONS

The above techniques are tested on different multispectral images and Landsat Images. The results of a Multispectral image below shows the output image after extraction using different methods, where the extracted water body is represented in white color. The software used for implementation is MatLab 7.0 on Core 2 Duo processor speed of 1.6 GHz.

A. Dataset Description

In this paper we have taken 50 multi spectral and LandSat images for this research.

B. Segmentation Results

In this approach we have segmented the image using R method, Whole method and finally by using the Proposed Whole- R method. One image taken from database and its segmented results using all three methods are shown below.



Fig. 5 Input Image

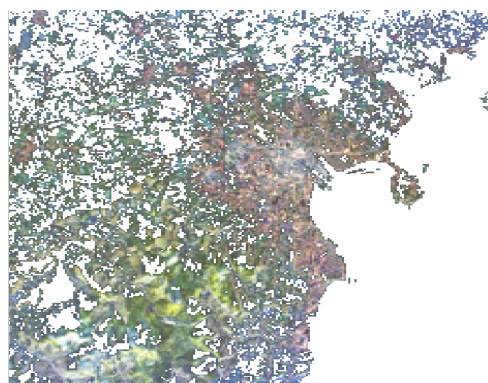

Fig. 6 Output Image Using R Method

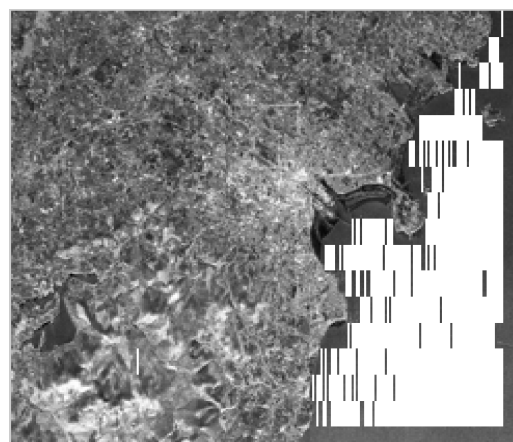

Fig. 7 Output Image Using Whole Method

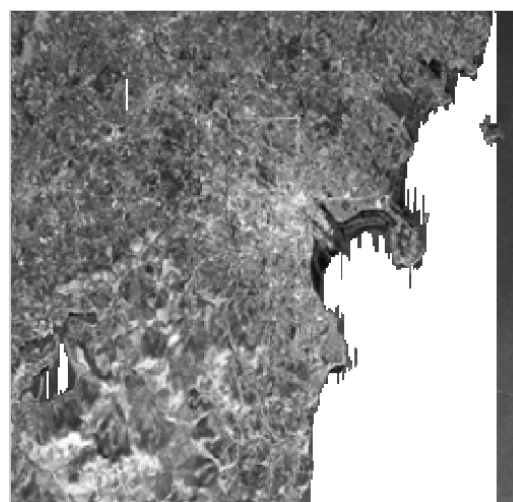

Fig. 8 Output Image Using Integrated Whole-R Method

C. Comparative Analysis

A comparative analysis in terms of accuracy is done for all the three methods and an accuracy graph is plotted in Fig.9.

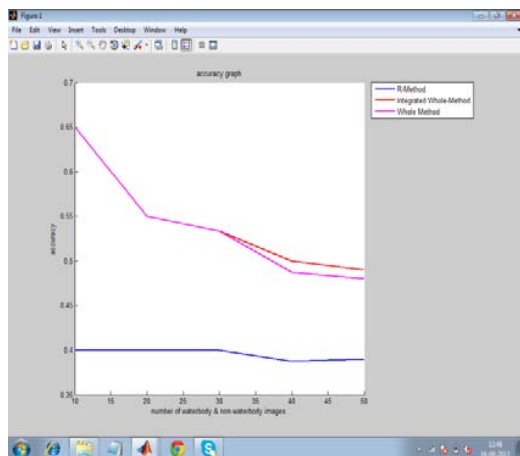

Fig. 9 Accuracy Plot

Fig. 9 is an accuracy graph with number of images on x axis and accuracy on y axis. The graph shows that the accuracy of extraction of the R method is 0.4 for 10 images and it decreases slightly with increase in number of images. The accuracy for both Whole method and the proposed Whole-R method is 0.65 for 10 images and the accuracy decreases with increase in number of images for both the methods but the decrease is less for integrated Whole-R method. This shows that the Integrated Whole-R method is good in terms of accuracy of extraction.

IV. CONCLUSION

This paper represents a technique for extraction of water bodies accurately from a remote sensing image by using an integrated method which is a combination of R method and whole method. The water and land are separated by step by step application of the above methods. The output of the R method indicates extraction of waterbodies with perfect edges but with some small false water bodies spread over the image. The results of whole method filters out false water bodies but the edges are not perfect, hence the proposed Whole-R method, extracts water bodies with perfect edges and also filters out false water bodies and a high precise water body extraction is achieved with improved accuracy. This system needs no manual intervention throughout the extraction process, hence achieves the goal of automatic extraction of water bodies.

V. FUTURE ADVANCEMENTS

The proposed method can be applied for images without shadows of other features. If the edges of water body in the input image contains shadows of other features then extraction accuracy decreases. Thus the system can further be improved in terms of extraction accuracy by taking into consideration the shadows of other features at the edges of water bodies.

REFERENCES

- [1] Jiancheng Luo, Yongwei Sheng, Zhanfeng Shen, Junli Li, "High Precise Water Extraction based on Spectral- Spatial Coupled Remote Sensing Information" IEEE and IGARSS 2010.
- [2] Y. W. Sheng, Q. G. Xiao, "Water-body identification in cloud contaminated NOAA/AVHRR image," *Environmental Remote Sensing*, vol. 9, no. 4, pp. 247-255, 1994.
- [3] J.K. Du, Y.S. Huang, X.Z. Feng, Z.L. Wang, "Study on water bodies extraction and classification from SPOT image," *Journal of Remote Sensing*, vol. 5, no. 3, pp. 214-219, 2001.
- [4] H. Liu, K.C. Jezek, "Automated extraction of coastline from satellite imagery by integrating canny edge detection and locally adaptive thresholding methods," *International Journal of Remote Sensing*, vol. 25, no.5, pp. 937 – 958, 2004.
- [5] S.K. McFeeters, "The use of Normalized Difference Water Index (NDWI) in the delineation of open water features," *International Journal of Remote Sensing*, vol. 17, no. 7, pp. 1425-1432, 1996.
- [6] T. Young " On the theory of light and colors" philosophical transactions of the royal society of London, 92, (1802) : 20-71
- [7] Fundamentals of Digital Image Processing, Anil K. Jain- 2006 edition.
- [8] F.A. Kruse, A.B. Lefkoff, J.W. Boardman, K.B. Heidebrecht, A.T. Shapiro, P.J. Barloon, A.F.H. "Goetz The spectral image processing system (SIPS) — interactive visualization and analysis of imaging spectrometer data", *Remote Sensing of Environment*, vol.44, no.2-3, pp. 145-163, 1993.
- [9] Digital Image processing by Rafael Gonzalez
- [10] D.G. Zhu, X.G. Meng, D.X. Zheng, Z.J. Qiao, Z.G. Shao, C.B. Yang, J.E. Han, J. Yu, Q.W. Meng, R.P. Lv, "Change of rivers and lakes on the Qinghai-Tibet Plateau in the past 25 years and their influence factors," *Geological Bulletin of China*, vol. 26, no. 1, pp.22-30, 2007.
- [11] S. Nandagopalan, Dr. B. S Adiga & N. Deepak, "A Universal Model for Content Based Image Retrieval," proceedings of world academy of science, engineering and technology, vol: 36, Dec. 2008.
- [12] Hanan Mahmoud, Ezzat Mahmoud & Alaa Abd El Fatah, "A Fast Adaptive Content Based Image Retrieval System of Satellite Image Database Using Relevance Feedback." Proceedings of world academy of science, engineering and technology, vol. 13.May: 2006
- [13] Waqas Rasheed, Youngeun & Jinsuk Kang, "Image Retrieval Using Maximum Frequency of Local Histogram based Color Correlogram." IEEE Trans on Image Processing, vol. 15 No: 4, pp.322-326, April. 2008.
- [14] Serkan Kiranyaz, Miguel Ferreira & Moncef Gabbouj, "Automatic Object Extraction Over Multiscale Edge Field for Multimedia Retrieval." IEEE Trans on Image Processing, vol. 15. No: 12, pp: 3759-3770, Dec. 2006.
- [15] Smeulders, A.W.M Worring, Santini. S & Gupta. A, "Content Based Image Retrieval at the End of Early Years," IEEE Trans on Pattern Analysis and Machine Intelligence," vol.22, issue.12, pp. 1349-1380, Dec-2000.
- [16] Jennifer J. Ranjani & Dr. S. J. Thiruvengadam." Entropy Based Segmentation for Visual Content Description in CBIR Using SAR Images," Proceedings of International Conference on CBIR, PP. 139-142.
- [17] C. Xiang & Huang, "Feature Extraction Using Recursive Cluster Based Linear Discriminant with Application to Face Recognition," IEEE Trans on Image Processing, vol: 15, no: 12, pp. 3824-3831, Dec.2006.