

Flow Characteristics and Heat Transfer Enhancement in 2D Corrugated Channels

Veli Ozbolat, Nehir Tokgoz, Besir Sahin

Abstract—Present study numerically investigates the flow field and heat transfer of water in two dimensional sinusoidal and rectangular corrugated wall channels. Simulations are performed for fully developed flow conditions at inlet sections of the channels that have 12 waves. The temperature of the input fluid is taken to be less than that temperature of wavy walls. The governing continuity, momentum and energy equations are numerically solved using finite volume method based on SIMPLE technique. The investigation covers Reynolds number in the rage of 100-1000. The effects of the distance between upper and lower corrugated walls are studied by varying H_{\min}/H_{\max} ratio from 0.3 to 0.5 for keeping wave length and wave amplitude values fixed for both geometries. The effects of the wall geometry, Reynolds number and the distance between walls on the flow characteristics, the local Nusselt number and heat transfer are studied. It is found that heat transfer enhancement increases by usage of corrugated horizontal walls in an appropriate Reynolds number regime and channel height.

Keywords—Corrugated Channel, CFD, Flow Characteristics, Heat Transfer.

NOMENCLATURE

a	wavy amplitude, mm
H	height of the channel, mm
D_h	hydraulic diameter, mm ($2H_{\min}$)
h	heat transfer coefficient, W/m ² K
k	thermal conductivity, W/mK
L_w	wavelength of the wavy wall, mm
L	length of the channel, mm
C_p	specific heat, J/kgK
Nu	local Nusselt number
p	pressure, pa
Re	Reynolds number
S	surface geometry function
T	Temperature, K
u, v	velocity components, m/s
x, y	horizontal and vertical coordinates

Greek Symbols

ρ	density, kg/m ³
α	thermal diffusivity, m ² /s
θ	dimensionless temperature
μ	dynamic viscosity, kg/ms
ν	kinematic viscosity, m ² /s

Subscripts

in inlet

Veli Ozbolat and Besir Sahin are with the Mechanical Engineering Department, Cukurova University, Balcali/Adana, 01330 Turkey (e-mail: vobolat@cu.edu.tr, bsahin@cu.edu.tr).

Nehir Tokgoz is with the Energy Systems Engineering Department, Osmaniye Korkut Ata University, Osmaniye, 80000 Turkey, (e-mail: nehirtokgoz@osmaniye.edu.tr).

min	minimum
max	maximum
w	wave

I. INTRODUCTION

POTENTIAL heat transfer enhancement in heat exchanger devices has recently gained great popularity because of the importance of these devices in numerous engineering applications. There are several methods used to improve heat transfer enhancement in heat exchangers. One way to increase heat transfer rate is to use optimum wall geometry that gives minimum pressure loss. Corrugated ducts are basic channel geometry used in heat exchangers since they are relatively easy to fabricate, increase compactness and improve heat transfer efficiency if implemented in an appropriate Reynolds number regime. Nishimura et al. [1], [2] and Wang and Vanka [3] observed experimentally and numerically that corrugated channels do not have significant effects on heat transfer enhancement if operated in steady regime. Due to the recirculation regions near the wall, using wavy wall enhances mixing of the fluid, which leads improvement in heat transfer. In addition, corrugated walls are effective on heat transfer enhancement by breaking and destabilizing the thermal boundary layer. Therefore, wavy surfaces operate as turbulence promoters to increase the local heat transfer [4].

In the literature, many experimental and numerical studies for fluid flow and heat transfer in the corrugated channels have been conducted. Goldstein and Sparrow [5] were the first to study the local heat and mass transfer characteristics of wavy wall channels. A channel consisting of two corrugated waves was used for laminar, transitional, and low Reynolds number turbulent flow regimes. It is concluded in this study that corrugated walls were moderately effective on heat transfer rate in the laminar flow regime. However, heat transfer rate increased by a factor of three compared with the smooth duct when the flow was in the low-Reynolds-number turbulent regime. O'Brien and Sparrow [6] conducted experiments to investigate forced convection heat transfer coefficients and friction factors for flow in a corrugated duct. The results showed that heat transfer was enhanced by a factor of 2.5 and the friction factor was significantly greater than that of straight duct. Garg and Maji [7] numerically studied the heat transfer of sinusoidal wavy channels with 0° phase shift. Their study showed that local Nusselt number to be proportional to Reynolds number and change sinusoidally in the flow direction. Niceno and Nobile [8] numerically studied two-dimensional steady and time-dependent fluid flow and heat transfer in sinusoidal and arc-shaped channels. For both geometrical configurations, corrugated walls had a negligible

effect on heat transfer enhancement in comparison to parallel-plate channel in steady flow regimes at lower Reynolds number values. Moreover, they both have higher pressure drop compare to that of parallel-plate channel under fully developed flow conditions. On the other hand, heat transfer rate increased for both sinusoidal and arc-shaped wavy channels when the flow became unsteady. Tanda and Vittori [9] presented a numerical study for the laminar fully-developed flow and heat transfer in a two-dimensional channel. In that study, effects of the channel geometry, Reynolds and Prandtl numbers on the flow field and heat transfer was investigated. They showed that wall-to-wall spacing and wave height had significantly effects on streamlines contours and heat transfer coefficients. In addition, pressure drop of the wavy channel was always greater than that of straight channel for the same flow rate and heat transfer conditions.

In this paper, flow field and heat transfer enhancement in corrugated channels with sinusoidal and rectangular walls are investigated numerically. Effects of the wall geometry, the Reynolds number and the distance between channel walls on flow and heat transfer characteristics are presented and analyzed.

II. NUMERICAL METHOD AND MODEL DESCRIPTION

A. Governing Equations

A Standard Computational Fluid Dynamic approach has been considered for this study. The upper and lower walls are isothermally heated and the temperature of the input fluid is taken less than that temperature of wavy walls. The flow is taken Newtonian, laminar, two-dimensional and incompressible. Based on these assumptions, the continuity, momentum and energy equations are:

$$\frac{\partial u}{\partial x} + \frac{\partial v}{\partial y} = 0 \tag{1}$$

$$u \frac{\partial u}{\partial x} + v \frac{\partial u}{\partial y} = -\frac{1}{\rho} \frac{\partial p}{\partial x} + \left(\frac{\partial^2 u}{\partial x^2} + \frac{\partial^2 u}{\partial y^2} \right) \tag{2}$$

$$u \frac{\partial v}{\partial x} + v \frac{\partial v}{\partial y} = -\frac{1}{\rho} \frac{\partial p}{\partial y} + \left(\frac{\partial^2 v}{\partial x^2} + \frac{\partial^2 v}{\partial y^2} \right) \tag{3}$$

$$u \frac{\partial T}{\partial x} + v \frac{\partial T}{\partial y} = \alpha \left(\frac{\partial^2 T}{\partial x^2} + \frac{\partial^2 T}{\partial y^2} \right) \tag{4}$$

where

$$n_f = \frac{\mu}{\rho} \tag{5}$$

$$\alpha = \frac{k}{\rho c_p} \tag{6}$$

B. Calculation Methods

Non-dimensional parameter is defined as:

Temperature:

$$\theta = \frac{T - T_{in}}{T_w - T_{in}} \tag{7}$$

Reynold Number:

Reynolds number is the ratio of inertial forces to viscous forces for the fluid flow. It can be expressed ad follow:

$$Re = \frac{\rho u_m D_h}{\mu} \tag{8}$$

where

$$D_h = 2H_{min} \tag{9}$$

Nusselt Number:

Nusselt number is the ratio of convective to conductive heat transfer cross the boundary layer. The local Nusselt number along the wall can be expressed as:

$$Nu_x = \frac{h_x D_h}{k} \tag{10}$$

C. Problem Description

Present study numerically simulates fully developed flow and heat transfer through corrugated channels. The channels consist of two corrugated walls with wavelength (L_w) and amplitude (a). Calculations are presented for a channel consisting of 12 waves. The profile of the upper wavy wall of sinusoidal channel shown is defined by

$$S(x) = \frac{H_{min}}{2} + a \sin \frac{2\pi x}{L_w}$$

The geometries of the sinusoidal and rectangular corrugated channels are illustrated and detailed in Fig. 1, and Table II.

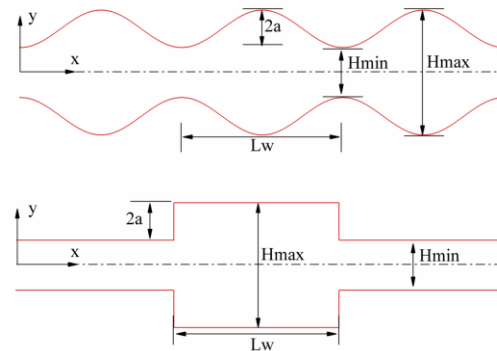

Fig. 1 Schematic diagram of the channel

TABLE I
GEOMETRICAL CONFIGURATIONS STUDIED

Model	H _{min} /H _{max}
R1	0.3
R2	0.4
R3	0.5

TABLE II
PLATE DIMENSIONS

Model	Dimension
Wave length, L_w	28 mm
Wave amplitude, a	3.5 mm
Min. spacing, H_{min}	6 mm, 9.33 mm, 14 mm
Max. spacing, H_{max}	20 mm, 23.33 mm, 28 mm

Number of corrugations: 12

D. Boundary Conditions

Fully developed flow, and uniform temperature of the inflow of water were applied as boundary condition at the channel entrance. At the outflow boundary, the outlet pressure was set as an atmospheric. At upper and lower slip conditions and constant wall temperature were specified.

E. Numerical Procedure

The governing equations of flow have been discretized by a finite volume method and pressure-velocity coupling system has been resolved by using the SIMPLE algorithm. The grids are non-uniform. Grids are finer near the boundaries while coarser at the core region (Fig. 2). As the convergence criterion, 10^{-8} was chosen for all parameters in computational domain. A time step of 0.004 was used for all calculations.

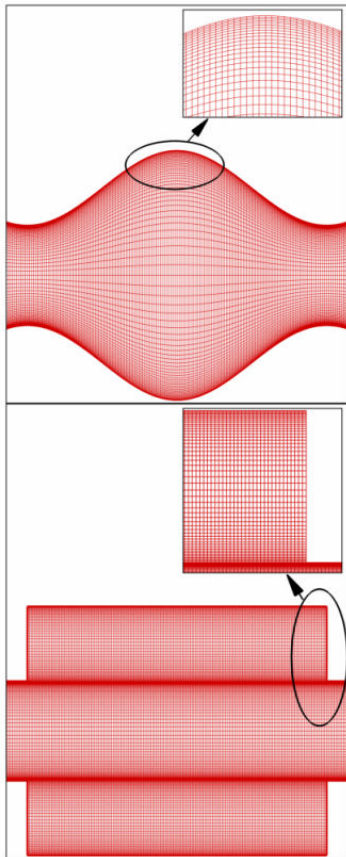

Fig. 2 Samples of grid configuration used in the present computation

The accuracy of the numerical results depends on the grid resolution. For this purpose, the grid independency test was

performed for all geometries. Friction factors of the channels for model R2 were investigated for different grid size and shown in Tables III and IV for sinusoidal and rectangular corrugated wall channels respectively. It is found that 160 (along x-direction) by 72 nodes (along y-direction) for one wave, can adequately resolve the problem and further increase in the number of grids do not affect the result.

TABLE III
GRID INDEPENDENCE STUDY
FRICTION FACTORS FOR SINUSOIDAL WALL CHANNEL FOR R2

Re	64x36	96x45	128x60	160x72	192x80
100	0.49767	0.49279	0.49295	0.49294	0.49301
250	0.27122	0.26473	0.26386	0.26344	0.26333
500	0.22019	0.21575	0.21488	0.21456	0.21449
1000	0.20436	0.20131	0.20036	0.20001	0.19995

TABLE IV
GRID INDEPENDENCE STUDY
FRICTION FACTORS FOR RECTANGULAR WALL CHANNEL FOR R2

Re	64x36 64x90	96x45 96x112	128x60 128x150	160x72 160x180	192x80 192x200
100	0.81784	0.81914	0.81975	0.81954	0.81972
250	0.43764	0.43749	0.43714	0.43813	0.43599
500	0.32138	0.32124	0.32391	0.32391	0.32005
1000	0.25800	0.25784	0.26168	0.26168	0.25680

III. RESULTS AND DISCUSSION

Fig. 3 shows the time-averaged streamlines for three geometric models for both sinusoidal and rectangular corrugated channels at a Reynolds number of 1000. The time-averaged streamlines pattern for all the geometries exhibit existence of only one recirculation region on each wave of the channel.

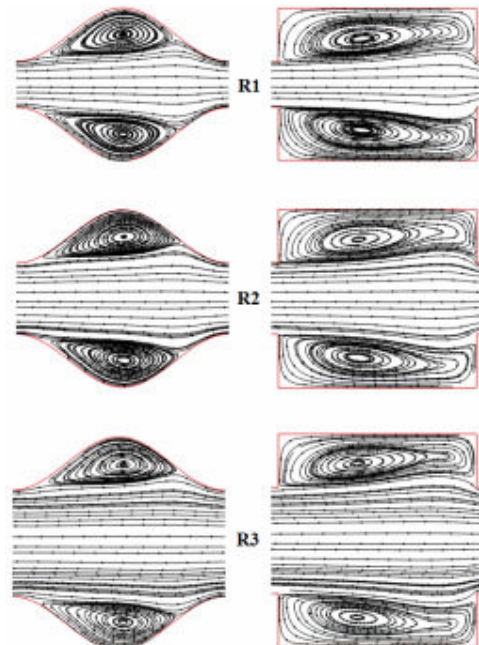

Fig. 3 Time-averaged streamline plots at Re=1000 for three different models for sinusoidal and rectangular corrugated channels

It can be seen from the non-dimensional isotherms contours in Fig. 4, as the Reynolds number of the flow increases, the boundary layer narrows, hence the isotherm lines move toward the walls. Therefore, Nu number and heat transfer between the wall and fluid tend to enhance.

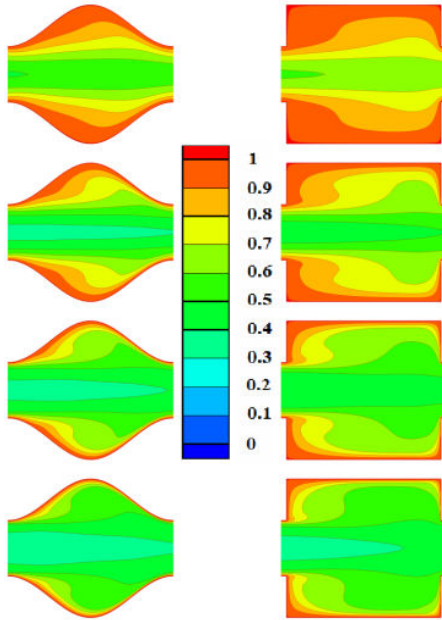

Fig. 4 Time-averaged isotherms plots with various Reynolds number for R2 for sinusoidal and rectangular corrugated channels

The isotherms of all models display higher thermal gradient along the streamwise direction. It is observed that the thickness of thermal boundary layer decreases with increase in H_{min}/H_{max} ratio.

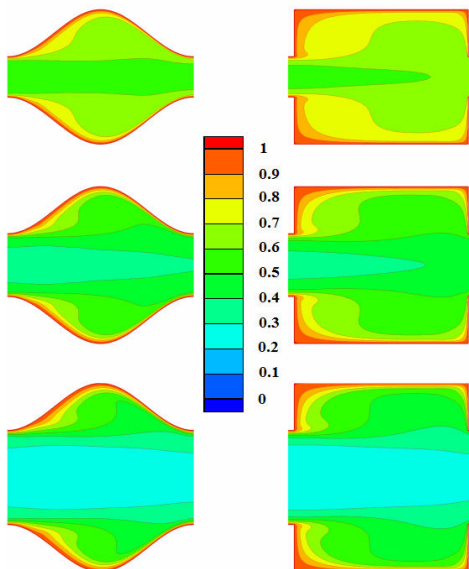

Fig. 5 Time-averaged isotherms plots at Re=1000 for three different models for sinusoidal and rectangular corrugated channels

Figs. 6 (a)-(c) show the variation of the local Nusselt number along the lower walls of the flat, rectangular and sinusoidal channels for model R2 with various Re number values. The variation trend in the local Nusselt number is same for all the Reynolds number investigated in this study. The local Nusselt number decreases in diverging sections and increases in converging sections of the wavy channel since as the flow moves, the velocity decreases and consequently heat transfer rate is increased. Highest peak points of the local Nusselt number are seen over the duct throats. Furthermore, when the Reynolds number increases, the local Nusselt number along the corrugated wall increases. Both corrugated channels have higher Nusselt number than flat channel.

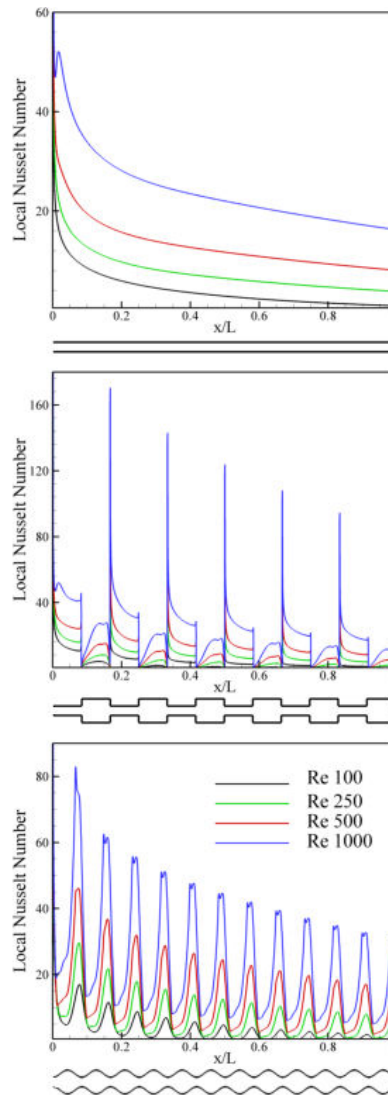

Fig. 6 Variation of local Nusselt number along the lower wavy wall with various Reynolds number for R2 for flat channel, rectangular corrugated channel and sinusoidal corrugated channel

Figs. 7 (a) and (b) show the variation of the local Nusselt number along the lower walls of the rectangular and sinusoidal

channels for all models considered in this study for a Reynolds number of 1000. The variation trend in local Nusselt number is same for all the models. The local Nusselt number decreases in diverging sections and increases in converging sections of the corrugated channel since as the flow moves, the velocity decreases and consequently heat transfer rate is increased. Highest peak points of the local Nusselt number are seen over the duct throats. In addition, when the distance between the upper and lower walls increases, the local Nusselt number along the corrugated wall increases.

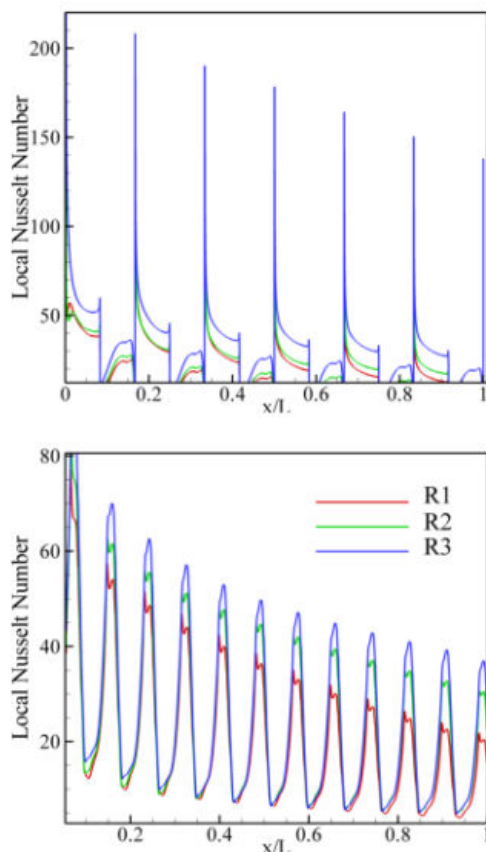

Fig. 7 Variation of local Nusselt number along the lower corrugated wall at Re 1000 for three models for both geometry

IV. CONCLUSION

Fluid flow and heat transfer through sinusoidal and rectangular corrugated channels have been simulated numerically. The effects of Reynolds number and distance between walls have been investigated for sinusoidal and rectangular corrugated channels and compared each others. Results show that the heat transfer through corrugated walled geometries is always higher than that of the flat plate. It is observed that heat transfer between the corrugated walls and base flow depends on the distance between walls. As the Reynolds number increases, the isotherm lines move toward the corrugated walls and the Nusselt number and heat transfer

increase. The sudden increases in the local Nusselt number occur at the duct throats.

REFERENCES

- [1] T. Nishimura, Y. Ohori, Y. Kawamura, Flow Characteristics in a Channel with Symmetric Wavy Wall for Steady Flow, *Journal of Chemical Engineering of Japan*, 17 (1984) 466-471.
- [2] T. Nishimura, S. Murakami, S. Arakawa, Y. Kawamura, Flow Observations and Mass-Transfer Characteristics in Symmetrical Wavy-Walled Channels at Moderate Reynolds-Numbers for Steady Flow, *International Journal of Heat and Mass Transfer*, 33 (1990) 835-845.
- [3] G. Wang, S.P. Vanka, Convective Heat-Transfer in Periodic Wavy Passages, *International Journal of Heat and Mass Transfer*, 38 (1995) 3219-3230.
- [4] M. Gradeck, B. Hoareau, M. Lebouche, Local analysis of heat transfer inside corrugated channel, *International Journal of Heat and Mass Transfer*, 48 (2005) 1909-1915.
- [5] J.L. Goldstein, E.M. Sparrow, Heat/mass transfer characteristics for flow in a corrugated wall channel *ASME Journal of Heat Transfer*, 99 (1977) 187-195.
- [6] J.E. O'Brien, E.M. Sparrow, Corrugated-Duct Heat Transfer, Pressure Drop, and Flow Visualization, *ASME Journal of Heat Transfer*, 104 (1982) 410-416.
- [7] V.K. Garg, P.K. Maji, Flow and Heat-Transfer in a Sinusoidally Curved Channel, *International Journal of Engineering Fluid Mechanics*, 1 (1988) 293-319.
- [8] B. Niceno, E. Nobile, Numerical analysis of fluid flow and heat transfer in periodic wavy channels, *International Journal of Heat and Fluid Flow*, 22 (2001) 156-167.
- [9] G. Tanda, G. Vittori, Fluid flow and heat transfer in a two-dimensional wavy channel, *Heat and Mass Transfer*, 31 (1996) 411-418.