

Ribbon Beam Antenna for RFID Technology

T. Zalabsky, P. Bezousek, T. Shejbal

Abstract—The paper describes new concept of the ribbon beam antenna for RFID technology. Antenna is located near to railway lines to monitor tags situated on trains. Antenna works at 2.45 GHz and it is fabricated by microstrip technology. Antenna contains two same mirrored parts having the same radiation patterns. Each part consists of three dielectric layers. The first layer has on one side radiation elements. The second layer is only for mechanical construction and it sets optimal electromagnetic field for each radiating elements. The third layer has on its top side a ground plane and on the bottom side a microstrip circuit used for individual radiation elements feeding.

Keywords—RFID, cosecant radiation pattern, ribbon beam, patch antenna, microstrip.

I. INTRODUCTION

THE developed antenna is a part of a railway information system. This system consists of RFID tags situated on trains and of RFID readers located near to railway lines, communicating with an information center.

Nowadays antennas with circular radiation pattern in horizontal plane are used for these readers or in the ribbon radio networks [1]. These types of antennas do not use radiated power effectively because they radiate much power in the front direction. Another possibility is to use two Yagi antennas oriented to the opposite sides along rails [2]. This system has disadvantage in very low radiation in the transverse directions. Normally the low coverage at short distances is not a problem but in our application (RFID) is necessary to cover near distances too.

Due to the above reasons the new antenna construction was chosen. The solution is based on two same mirrored oriented antennas with their same radiation pattern as shown on Fig. 1. The radiation pattern has cosecant squared shape in horizontal axis. This solution has good coverage at short distances from antennas to the railway line. This type of antenna has a higher gain which allows to reduce the transmit power or to achieve a higher range.

The whole antenna structure is designed on multilayer printed circuit board which is easy to fabricate and allows cost reduction of the all system.

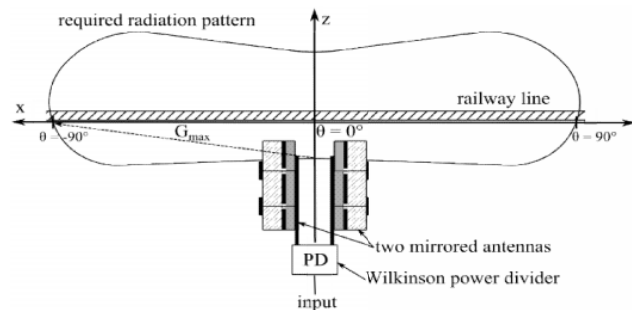

Fig. 1 Concept of antenna system

II. RADIATION PATTERNS

Horizontal radiation pattern should have cosecant squared shape. In reality we can only approach to this curve because a real antenna generates a rippled antenna response. If the antenna dimension and its elements number increase then the ripple decreases, what is shown on Fig. 2. There is a comparison between three traces for $N = 4$ (dashed line), 8 (continuous line) and 12 (dotted line) number of antenna elements. On the other hand the higher N needs higher dimensions of the antenna and more complicated distribution network to each radiator. For easier design it is useful if N is a power of two. Then symmetrical power dividers could be used in the distribution network. Due to this reason eight radiators were used. A signal distribution at the individual outputs is in Table I.

TABLE I
SIGNAL AMPLITUDES AND PHASES AT OUTPUTS OF THE HORIZONTAL DISTRIBUTION NETWORK

Indication element i	1	2	3	4	5	6	7	8
distribution of amplitude A_i	0.13	0.44	0.15	1	1	0.15	0.44	0.13
The phase difference between adjacent elements		-62.57	-56.25		-56.25		-62.57	
			50.71		-82.0		50.71	

P. Bezousek, T. Zalabsky, and T. Shejbal are with the Department of Electrical Engineering, University of Pardubice, Studentska 95, 53210 Pardubice, Czech Republic (e-mail: pavel.bezousek@upce.cz, tomas.zalabsky@student.upce.cz, tomas.shejbal@student.upce.cz).

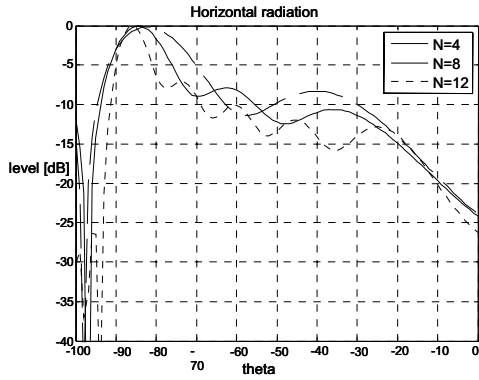

Fig. 2 Horizontal radiation pattern

The vertical beam width is not important so much in this application because we need to cover the whole area of the train. For this reason, we use only two radiation elements in the vertical axis with a uniform signal distribution. Dependence of vertical radiation pattern on the radiating elements number N including the patch element radiation pattern is shown on Fig. 3.

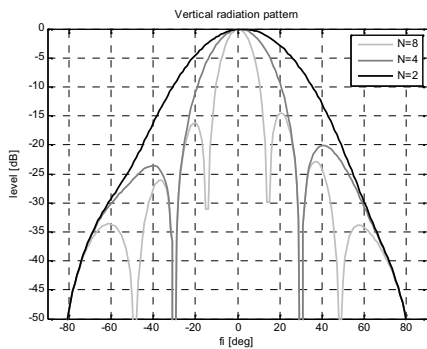

Fig. 3 Vertical radiation pattern

III. ANTENNA ARRANGEMENT

Antenna system consists of two same mirror oriented antenna parts so we may design one part of the whole antenna only. This antenna part structure is shown on Fig. 4. There are three dielectric layers. The FR4 substrate for the first layer was chosen. On the top side of this layer a feeder circuit is situated consisting of power dividers of Wilkinson and branch-line types. They set optimal amplitudes and phases for each radiating elements. On the bottom side of this layer is a ground plane. The second layer is made of a dielectric material and it is used for mechanical distance definition between the first and the third layer. It also sets the optimal electromagnetic field at individual radiators. The FR4 substrate is used for the third layer, carrying radiating elements – patches. Patch elements create the antenna array. In the horizontal direction rows of eight patches are used while in the vertical direction only two such rows are stacked. Individual power dividers outputs are connected to each patch by perpendicular pins.

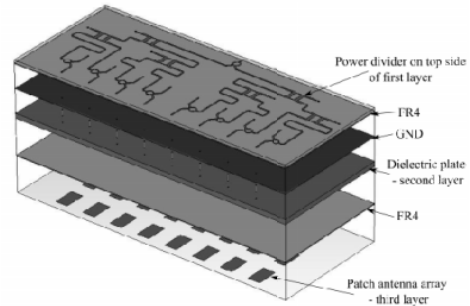

Fig. 4 Antenna structure

IV. PATCH ANTENNA DESIGN

We used a rectangular shape patch for the antenna construction (Fig. 5). Dimensions of the patch were calculated by equations from [3]. However, as the structure is multilayer it was necessary to optimize the patch dimensions using the microwave circuit simulator CST [4] to meet the desired parameters of the radiation pattern and the impedance match. The optimized length L of the microstrip antenna is 43mm, the width W is 24mm and the height of the all structure is 13mm.

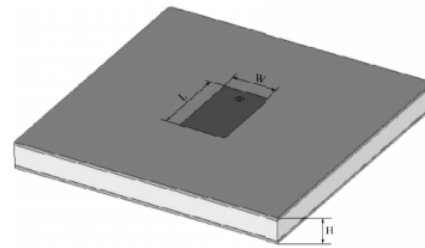

Fig. 5 Patch antenna – model in CST MWS

The measured return loss of one patch element is shown on Fig. 6. There is shown a good impedance match of the patch at the centre frequency. The return loss level is quite acceptable even in the range of 100 MHz.

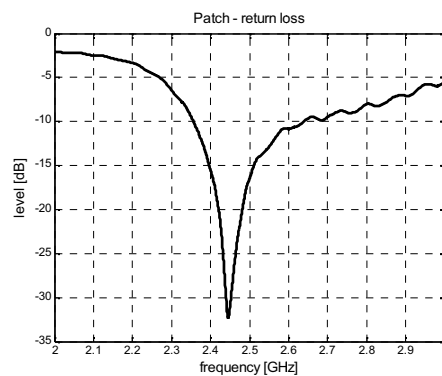

Fig. 6 Patch – return loss

V. POWER DIVIDERS DESIGN

Power dividers are important part of our design. The input device is a symmetrical power divider realized as Wilkinson

power divider. The further dividers in the horizontal distribution network are unsymmetrical. Matched unsymmetrical Wilkinson or Gysel power dividers occupy too large area so the branch line couplers were chosen for their realization [5], [6]. From the distribution of the amplitude at the output of horizontal distribution (Table I) it is obvious that all the asymmetrical power dividers will have the same power division ratio. The fabricated branch line coupler is shown on Fig. 7. The symmetrical Wilkinson power dividers at the outputs of the feeders form the vertical distribution network. To attain the required cosecant squared radiation pattern the dividers power ratio of 7.9 dB is needed and the return loss over 20 dB is necessary for a good function.

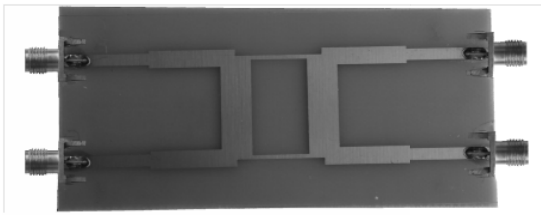

Fig. 7 Branch line power divider

The measured results are presented on Figs. 8 and 9. From the measurements of the Wilkinson power divider it is obvious that absolute value of S11 minimum is moved to the lower frequencies (50 MHz) but it is still acceptable because the value at the operating frequency is about -30 dB. The absolute values of the remaining ports reflection coefficients do not have significant minima but their levels are reasonable as well. The isolation between output ports (S₃₂) minimum is moved to lower frequencies (150 MHz) but the value can be accepted.

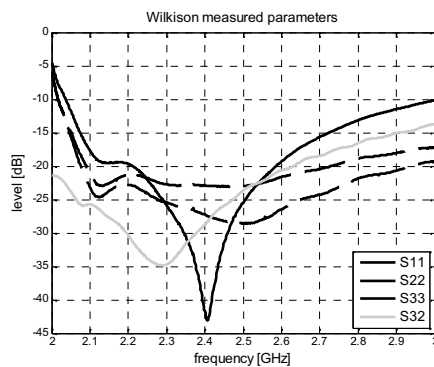

Fig. 8 Wilkinson measured parameters

From the results of the branch line coupler on Fig. 9 it is obvious that the absolute value minimum of S11 is moved to the lower frequencies (150 MHz) but it is still suitable because the value on operating frequency is about -24 dB. The results for other ports are similar. The absolute value of the transmission coefficient S₂₁ is -1.7 dB and that of S₃₁ is -9.6 dB. From these values it is evident that power ratio is 7.9 dB, so it is pretty the same as the required one.

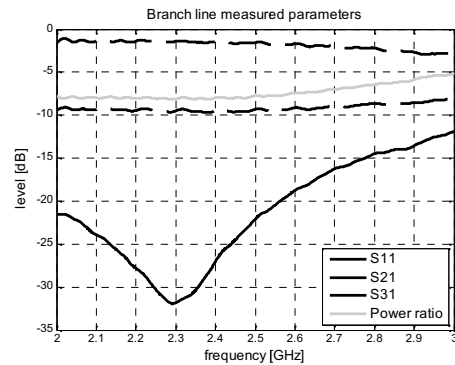

Fig. 9 Branch line measured parameters

VI. CONCLUSION

In this paper cosecant square antenna for RFID technology was described. Based on the results of the computer simulation laboratory samples of each power dividers and of the patch element were fabricated. These parts were measured and from the measured results it is evident that the manufactured components correspond well to the computer model. Thus a suitability of these components for the intended application in the ribbon antenna was verified.

On the bases of the presented results the signal distribution network and the complete antenna system was designed in CST MWS and now it is fabricated.

ACKNOWLEDGMENT

The described research was supported by the Internal Grant Agency of University of Pardubice, the project No. SGFEI 09/2013 and by the Czech Ministry of Industry and Trade, the research project No. FR TI-2/480.

REFERENCES

- [1] G. L. Freytag, a B. Jecko. Cosecant-squared pattern antenna for base station at 40 GHz. IEEE Antennas and Propagation Society Symposium, 2004. IEEE, 2004, 2464-2467 Vol.3. DOI: 10.1109/APS.2004.1331872. available from: <http://ieeexplore.ieee.org/lpdocs/epic03/wrapper.htm?arnumber=1331872>.
- [2] Railway Radio System TRS, T-CZ Inc., Technical description.
- [3] BALANIS, Constantine A. Antenna theory: analysis and design. 3rd ed. Hoboken: Wiley-Interscience, 2005, xvii, 1117 s. ISBN 978-0-471-66782-7.
- [4] CST MICROWAVE STUDIO: 3D EM simulation software [online]. [cit. 2013-02-24]. Available from: <http://www.cst.com/Content/Products/MWS/Overview.aspx>.
- [5] D. M. Pozar and M. Aksun, Microwave engineering. 2nd ed. New York: Wiley, 1997c1998, 716 p. ISBN 04-711-7096-8.
- [6] GYSEL, U.H. A New N-Way Power Divider/Combiner Suitable for High-Power Applications. MTT-S International Microwave Symposium Digest. MTT005, 1975, s. 116-118. DOI:10.1109/MWSYM.1975.1123301. Available from: <http://ieeexplore.ieee.org/lpdocs/epic03/wrapper.htm?arnumber=1123301>.