

Comparison between Optimized Passive Vehicle Suspension System and Semi Active Fuzzy Logic Controlled Suspension System Regarding Ride and Handling

Mehrdad N. Khajavi, and Vahid Abdollahi

Abstract—The purpose of suspension system in automobiles is to improve the ride comfort and road handling. In this research the ride and handling performance of a specific automobile with passive suspension system is compared to a proposed fuzzy logic semi active suspension system designed for that automobile. The body-suspension-wheel system is modeled as a two degree of freedom quarter car model. MATLAB/SIMULINK [1] was used for simulation and controller design. The fuzzy logic controller is based on two inputs namely suspension velocity and body velocity. The output of the fuzzy controller is the damping coefficient of the variable damper. The result shows improvement over passive suspension method.

Keywords—Suspension System, Ride Comfort, Fuzzy Logic Controller, Passive and Semi Active System.

I. INTRODUCTION

SUSPENSION systems are classified in to three groups: Passive, Semi Active and Active suspension systems. Passive suspension system consists of an energy dissipating element, which is the damper, and an energy-storing element, which is the spring. Since these two elements can not add energy to the system this kind of suspension systems are called passive. Fig. 1 shows an active suspension system in which a force actuator replaces the suspension spring and damper in passive system.

Sensors continuously monitor the operating conditions of the vehicle body. Based on the signals obtained by the sensors and prescribed control strategy the force in the actuator is modulated to achieve improved ride and handling. It should be noted, that an active suspension system requires external power to function, and that there is also a considerable penalty in complexity, reliability, cost and weight.

Manuscript received November 28, 2006. This work is supported in part by Shahid Rajaei University, Tehran, Iran.

Mehrdad Nouri Khajavi is with the Mechanical Engineering Department, Shahid Rajaei University, Tehran, Iran.

Vahid Abdollahi is with the Electrical Engineering Department, Islamic Azad University, Karaj, Iran.

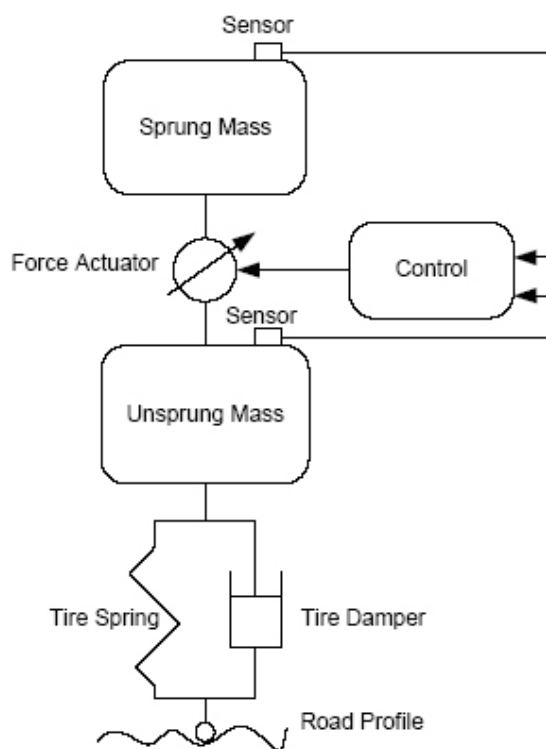

Fig. 1 Schematic of an active suspension system

To replace complexity and cost while improving ride and handling the concept of semi active suspension has emerged. In this kind of suspension system, the passive suspension spring is retained, while the damping force in the damper can be modulated in accordance with operating conditions. Fig. 2 shows the schematic view of a semi active suspension system.

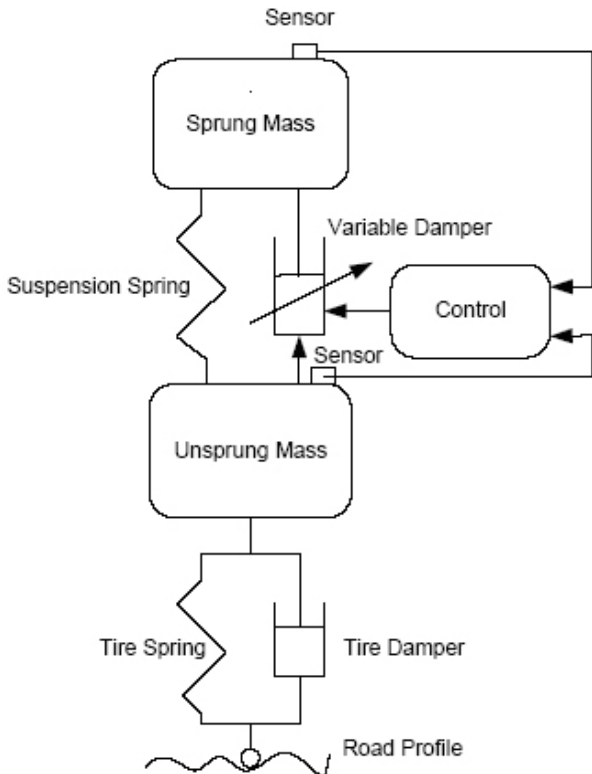

Fig. 2 Schematic of a semi active suspension system

The regulating of the damping force can be achieved by adjusting the orifice area in the damper, thus changing the resistance of fluid flow. Most recently the possible application of electrorheological and magnetorehological fluids to the development of controllable dampers has also attracted considerable interest [2] , [3]. An electrorheological fluid is a mixture of dielectric base oil and fine semiconducting particles. In the presence of an electric field, this fluid thickens allowing for continuous control of its apparent viscosity and hence its resistance to flow. This process is continuous and reversible, and the response is almost instantaneous.

A magnetorehological fluid is a mixture of micro-sized magnetizable particles suspended in a carrier fluid, such as silicone oil. The apparent viscosity of this type of fluid, and hence its resistance to flow, can be changed by a magnetic field. In comparison with a fully active suspension system, a semi active suspension requires much less power, and is less complex and more reliable.

II. MODEL DESCRIPTION

Many researchers used linear lower order models for initial development and analysis of semi active suspension system [4],[5],[6].After successful application using simple models, then more complex models, with nonlinearities and more DOF should be used. In this research a 2 DOF model is used to test the passive and fuzzy logic controller for the suspension system. Fig. 3 shows the 2 DOF model to derive the motion equations and designing fuzzy controller.

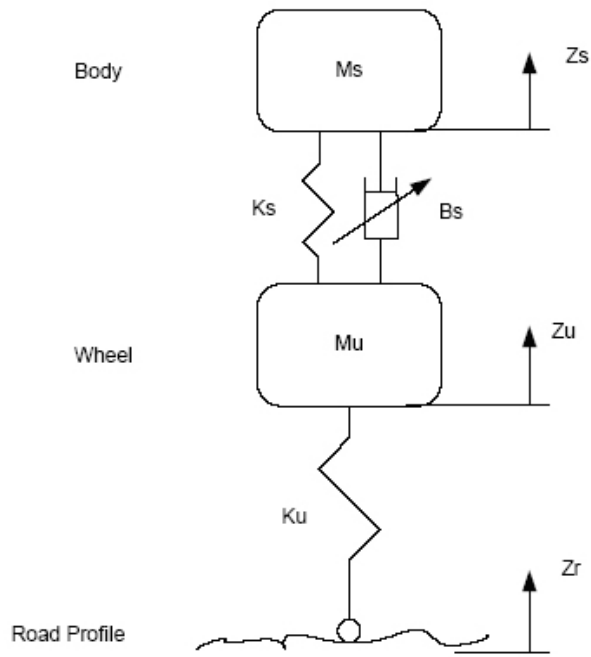

Fig. 3 Two DOF suspension model

The parameters of the model are for a specific automobile namely SAMAND obtained from IRANKHODRO Company. Table I shows SAMAND’s suspension parameters.

TABLE I
SAMAND’S SUSPENSION MODEL PARAMETERS

Description	Symbol	Value	Units
Sprung Mass	Ms	290	Kg
Unsprung Mass	Mu	50	Kg
Suspension spring rate	Ks	12000	N/m
Tire spring rate	Ku	200000	N/m
Damper rate	Bs	1140	N.Sec/m

Using Newton’s second law of motion, the linear differential equations describing the dynamics of the semi active suspension can be written as:

$$Ks(Zu - Zs) + Bs(\dot{Z}u - \dot{Z}s) = Ms.\ddot{Z}s \quad (1)$$

$$-Ks(Zu - Zs) - Bs(\dot{Z}u - \dot{Z}s) + Ku(Zr - Zu) = Mu.\ddot{Z}u \quad (2)$$

Where Z_s is the position of the sprung mass, Z_u is the position of the unsprung mass and Z_r is the road displacement. These equations are solved numerically using MATLAB's dynamic system simulation software, SIMULINK.

III. SEMI ACTIVE FUZZY LOGIC CONTROLLER

In classical control theory a mathematical model of the system is required. However, fuzzy logic based control does not require a mathematical model since it is a rule based system. Therefore fuzzy logic controller has an advantage over classical controller when it is applied to complex systems. It can be developed with minimal knowledge about the system dynamics.

Designing a fuzzy logic controller consists of the following four steps:

- 1) Fuzzification: In this step the crisp inputs are transformed to fuzzy values.
- 2) Rule design: In this step the fuzzy output truth values are calculated.
- 3) Computation: In this phase the required control actions are computed.
- 4) Defuzzification: In this step the fuzzy output is converted back to the crisp values.

The input linguistic variables chosen for the fuzzy controller are sprung mass velocity and the suspension velocity (relative velocity of sprung mass to unsprung mass). The output of the controller is the damping coefficient of the variable damper. The universe of discourse for both the input variables the sprung mass velocity and suspension velocity was divided in to three sections with the following linguistic variables. Positive (p), zero (z) and negative (n). The universe of discourse for the output variable, damping coefficient of the damper, was divided in to three sections with the following linguistic variables, small (s), medium (m) and large (l).

Trapezoidal membership functions were used for the linguistic variables because they produce smoother control action due to flatness at the top of the trapezoidal shape [5]. The membership functions used for the controller are shown in Figs. 4 to 6.

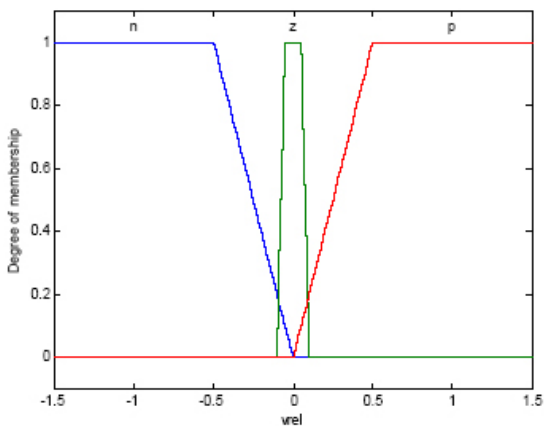

Fig. 4 Input membership function for relative velocity

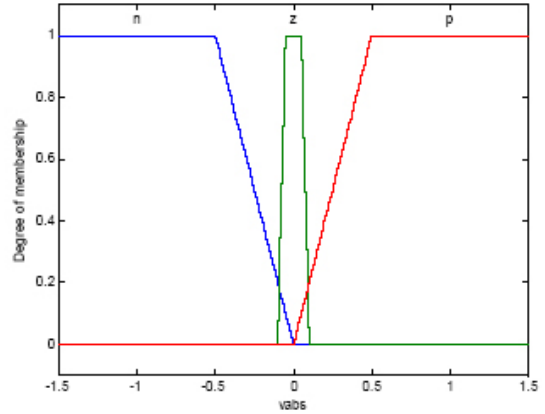

Fig. 5 Input membership function for sprung mass velocity

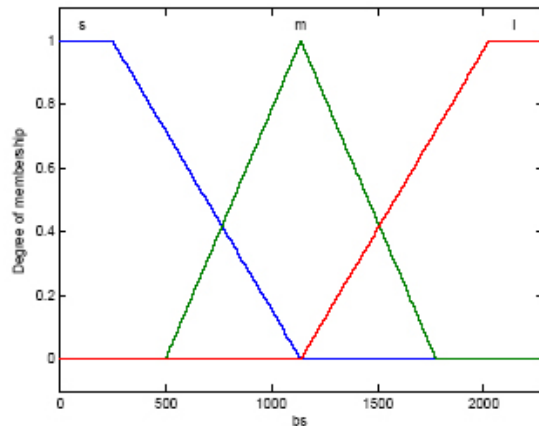

Fig. 6 Output membership function for damping coefficient

The objective of control is contained in the fuzzy rule base in the form of the linguistic variables using the fuzzy conditional statement. It is composed of the antecedent (IF-clause) and the consequent (THEN-clause). For example, one of the control rules can be stated as "If the relative velocity is negative and the sprung mass velocity is positive THEN the damping coefficient is small". Using these linguistic variables, a set of fuzzy rules was developed. The fuzzy rule base consisted of 9 rules. These rules are shown in Table II.

TABLE II
DAMPER CONTROLLER RULE BASE

V relative			
→			
	Negative	Zero	Positive
↓			
V body			
Negative	Large	Medium	Small
Zero	Medium	Medium	Medium
Positive	Small	Medium	Large

The fuzzy reasoning inference procedure used was max-product. The defuzzification procedure employed was bisector.

IV. SIMULATION

The quarter car suspensions for both passive system and fuzzy logic controlled system were simulated using MATLAB/SIMULINK. The fuzzy logic controller was designed using fuzzy logic block in simulink [7]. To update damping coefficient while the simulation was running a S-Function was written and added to the simulation block diagram.

To compare the performance of passive suspension system and fuzzy logic controlled suspension system, both of them were excited by a step input with the height of 0.05 m at $t=1$ sec. Fig. 7 shows the response of both systems to this excitation.

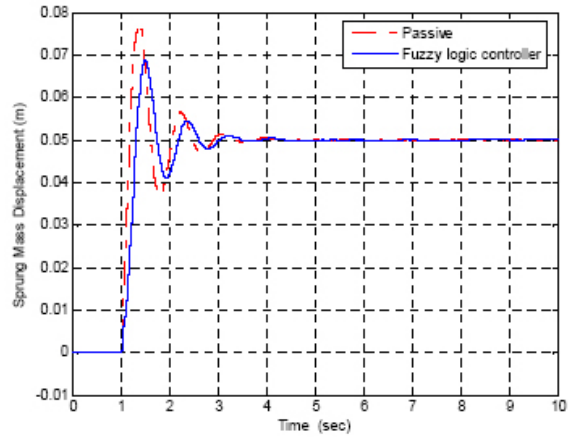

Fig. 7 Comparison of the responses of passive and semi active suspension systems to a step input

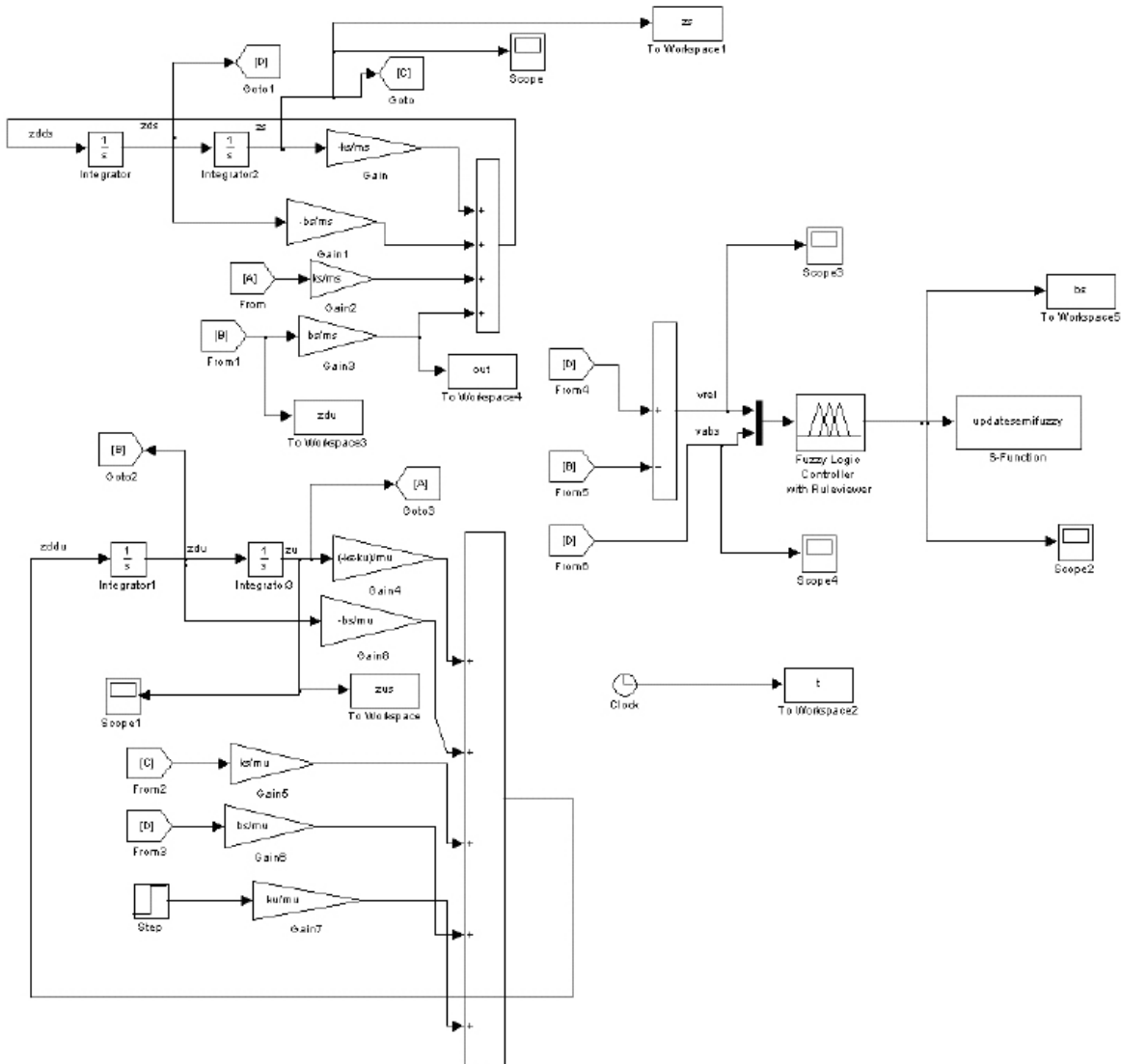

Fig. 8 Block diagram of the semi active suspension system with fuzzy logic controller

As can be seen from Fig. 7 the sprung mass displacement due to the step response has been reduced significantly over passive suspension system by using the proposed fuzzy logic controller. Reduction of the sprung mass displacement means more ride comfort.

Fig. 8 shows the simulink block diagram of the semi active suspension with fuzzy logic controller.

Fig. 9 shows the damper coefficient variation during 10 sec simulation time. Damping coefficient is the output of the fuzzy logic controller.

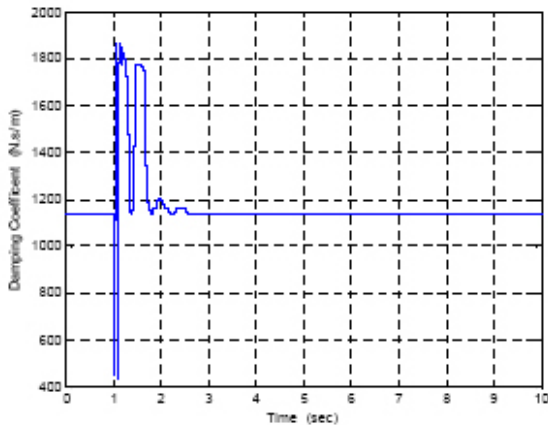

Fig. 9 Variation of the damping coefficient of the variable damper

V. CONCLUSION

The fuzzy logic controller successfully controlled the semi active suspension. When compared to the passive suspension system, fuzzy logic substantially decreased the sprung mass displacement and therefore increased ride comfort of the

automobile. Since there is no method to find the optimal damping coefficient to get the best performance this subject is currently under investigation.

REFERENCES

- [1] SIMULINK User's Guide. The MathWorks Inc., 2004.
- [2] G. Mui, D.L. Russell, and J. Y. Wong, "Nonlinear Parameter Identification of an Electro-Rheological Fluid Damper", *Journal of Intelligent Material Systems and Structures*, vol. 7, no. 5, 1996.
- [3] N. K. Petek, "Shock Absorber Uses Electrorheological Fluid", *Automotive Engineering*, June 1992.
- [4] Barr, A. J. and Ray, J. L., "Control of an Active Suspension Using Fuzzy Logic", *Proceedings of the Fifth IEEE International Conference on Fuzzy Systems*, Vol. 1, IEEE, 1996, pp. 42-48.
- [5] Al-Holou, N., Joo, D. S., and Shaout, A. "The Development of Fuzzy Logic Based Controller for Semi Active Suspension System", *Proceedings of the 37. Midwest Symposium on Circuits and Systems*, IEEE, 1996, pp.1373-1376.
- [6] Titli, A. and Roukieh, S., "Design of Active and Semi Active Automotive Suspension Using Fuzzy Logic", *Proceedings of the 12. Triennial World Congress of the International Federation of Automatic Control*, Vol. 3. Pergamon, Oxford, UK, 1995, pp. 73-77.
- [7] Fuzzy Logic Toolbox for use with MATLAB, The MathWorks Inc., 2004.

Mehrdad Nouri Khajavi was born in Tehran, Iran on October 1, 1961. This author became a Member (M) of IEEE in 2004. He received his M.S. and Ph.D. degrees in mechanical engineering from Amir Kabir University, Tehran, Iran in 1989 and 2002 respectively.

In 2002 he joined Shahid Rajaee University in Tehran-Iran, where he is currently an Assistant Professor of vehicle dynamics group. He is the author and co-author of more than 15 technical papers.

Dr. Khajavi is a member of ASME and SAE.