

Stability of Electrical Motor Supplied by a Five Level Inverter

Kelaiaia Mounia Samira, Labar Hocine, Bounaya Kamel, and Kelaiaia Samia

Abstract—The development of the power electronics has allowed increasing the precision and reliability of the electrical trainings, thanks to the adjustable inverters, as the Pulse Wide Modulation (PWM) five level inverters, which is the object of study in this article. The authors treat the relation between the law order adopted for a given system and the oscillations of the electrical and mechanical parameters of which the tolerance depends on the process with which they are integrated (paper factory, lifting of the heavy loads, etc.). Thus the best choice of the regulation indexes allows us to achieve stability and safety training without investment (management of existing equipment).

Keywords—multi level inverter, PWM, Harmonics, oscillation, control

I. INTRODUCTION

WITH the technological evolution of the electronics of the semi conductors, the non-traditional customer loads, such as Adjustable speed drivers [5], are being applied in increasing numbers due to the improved efficiencies and flexibility that can be achieved [10].

A notable trend in power electronics in recent years has been the widespread use of power semiconductor devices such as: power transistors; gate turn off thyristors (Gto) and Mosfet transistor devices which contribute in the improvement of power electronic quality systems by employing advanced power control strategies [12].

In fixed and variable frequency inverter power supplies, the increase of gate turn off thyristor capacity, permitted to get voltage source PWM inverter, as a variable means of power control [15],[8], providing the facility to adjust the output voltage and frequency with simultaneous attenuation of several lower order harmonics [7].

H. Labar: is with Department of Electrical Engineering, Faculty of Engineering Sciences, University of Annaba; B.P. 12, 23000, Algeria. (e-mail: Hocine.Labar@univ-annaba.org)

M.S. Kelaiaia is with Department of Electrical Engineering, Faculty of Engineering Sciences, University of Annaba; B.P. 12, 23000, Algeria. (phone/fax 213 3887 5398 ;e-mail: kelaiaiams@yahoo.fr)

S. Kelaiaia is with Department of Electrical Engineering, University of Souk Ahras; B.P. 12, 23000, Algeria. (e-mail: samiakelaiaia@yahoo.fr)

T. Mesbah is with Department of Electrical Engineering, Faculty of Engineering Sciences, University of Annaba B.P. 12, 23000, Algeria. (e-mail: mesbahatarek@yahoo.fr)

The DC link voltage of a conventional Gto inverter is about 2000 v. Since the DC link voltage of large capacity inverter is up to 4000 v [5]; from where the incompatibility of the existing Gto with this mode of link. For the inverter configuration whose DC link voltages are up to 4000 v, we use the series connected Gto inverter [2]; of which the phase difference between the two PWM carriers in the inverters is 180°. Harmonic components of the output voltage, that is an average voltage of the two inverters, are smaller than those of the single inverter [9]. Another configuration of the high voltage inverter, is a five level inverter fig.1, it guarantees equal voltage sharing of series connected Gto's, and harmonic components of the output voltage is less than those of the conventional inverters (two level inverters) [6] [3].

II. MULTI LEVEL INVERTER PRINCIPLE

The economic considerations, of this work is the reduction of circuit control, therefore at the difference of the other works having the same orientation, we propose to use only one carrier for the three phases simultaneously, unfortunately this consideration limits us in the choice of the frequency, that must obey to the law,

$$f_c = m/T \quad \text{with} \quad m = k \cdot 6, \quad k = 1, 2, 3, \dots, n$$

in order to avoid the creation of others even and non feature harmonics. The principle of GTO's switching remain the same [16], where we show on the table, the different sequences of switching as well as the corresponding five level voltages [13].

TABLE I
SWITCHING SEQUENCES OF GTO S

Bk1	Bk2	BK3	BK4	Vkm
Off	Off	On	On	-Uc/2
On	On	Off	Off	Uc/2
On	Off	On	Off	0

Bk_i: trigger control of the GTO G_{tki} of the leg k.

Each breaker G_{DKS} ($K \in \{1, 2, 3\}, S \in \{1, 2, 3, 4\}$) is ordered by the function F_{KS} . This function can take two values 0 or 1, so 1 if on and 0 when off. This function can be generalised for the inverter leg as:

$$F_{kS}^{down} = \overline{F_{kS}^{up}}, \quad k \text{ is the leg number}$$

According to these relations we found:

$$V_{AB} = V_{AM} - V_{BM} = (F_{11}^{up} \cdot F_{12}^{up} - F_{21}^{up} \cdot F_{22}^{up}) U_{c1} - (F_{13}^{down} \cdot F_{14}^{down} - F_{23}^{down} \cdot F_{24}^{down}) \cdot U_{c2}$$

$$V_{BC} = V_{BM} - V_{CM} = (F_{11}^{up} \cdot F_{12}^{up} - F_{31}^{up} \cdot F_{32}^{up}) U_{c1} - (F_{23}^{down} \cdot F_{24}^{down} - F_{33}^{down} \cdot F_{34}^{down}) \cdot U_{c2}$$

$$V_{CA} = V_{CM} - V_{AM} = (F_{31}^{up} \cdot F_{32}^{up} - F_{11}^{up} \cdot F_{12}^{up}) U_{c1} - (F_{33}^{down} \cdot F_{34}^{down} - F_{13}^{down} \cdot F_{14}^{down}) \cdot U_{c2}$$

Following this development, we write the potential at point A,B and C

$$\begin{bmatrix} V_A \\ V_B \\ V_C \end{bmatrix} = \frac{1}{3} \begin{bmatrix} 2 & -1 & -1 \\ -1 & 2 & -1 \\ -1 & -1 & 2 \end{bmatrix} \begin{bmatrix} F_1^{up} - F_1^{down} \\ F_2^{up} - F_2^{down} \\ F_3^{up} - F_3^{down} \end{bmatrix} E_c / 2$$

The three single voltages of output inverter are:

$$V_A = (2V_{AM} - V_{BM} - V_{CM}) / 3$$

$$V_B = (-V_{AM} + 2V_{BM} - V_{CM}) / 3$$

$$V_C = (-V_{AM} - V_{BM} + 2V_{CM}) / 3$$

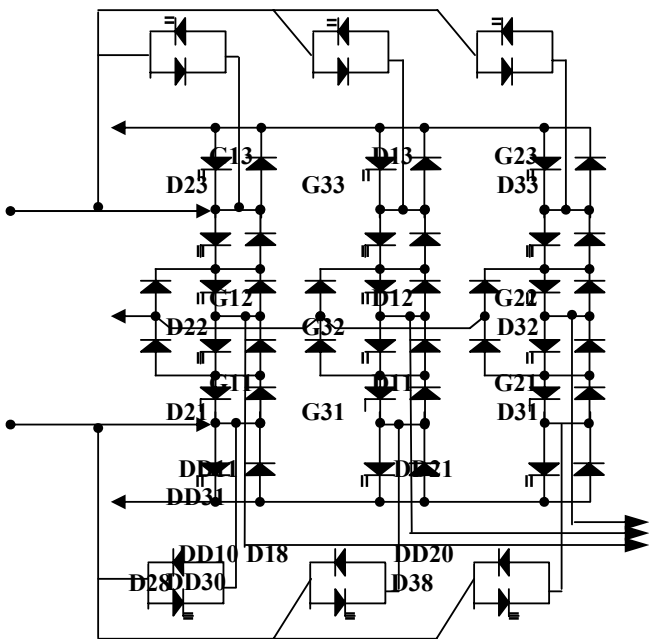

Fig. 1 Five level inverter Configuration

III. SIMULATION RESULTS

The simulation model fig.2 of the inverter supplying an induction motor (IM) see Annex is done by varying r & m. This type of inverter offer 27 possible out put voltage levels [4] fig.2, the time of its application define the RMS inverter out put voltage fig.4

TABLE II
POSSIBLE SEQUENCES

Vkm	Gk1	Gk2	Gk3	Gk4	Gk5	Gk6
2Uc	1	1	1	0	0	0
Uc	1	1	0	0	0	0
0	1	0	0	1	0	0
-Uc	0	0	0	1	1	0
-2Uc	0	0	0	1	1	1

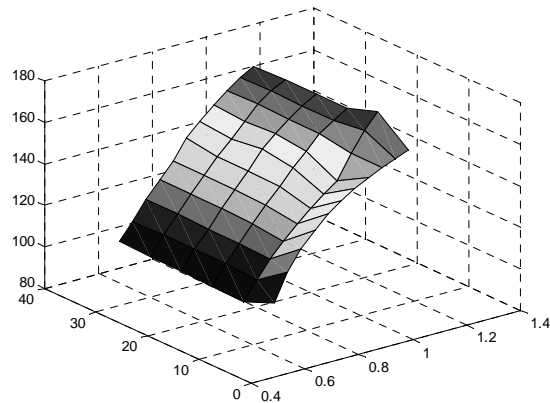

Fig. 2 Variation of RMS the inverter output voltage according to r and m

The other inverter improvements is the Total Harmonic Distortion (THD) witch depends on the choice of r and m simultaneously fig.5.

So for the voltage inverter out put

$$THD_V = 100 \cdot \sqrt{\sum_{H=2}^n U_H^2} / U_1 \%$$

And for the load current

$$THD_I = 100 \cdot \sqrt{\sum_{H=2}^n I_H^2} / I_1 \%$$

Where:

- I₁ and U₁ are respectively the fundamental current and voltage
- I_H and U_H are respectively the harmonic current and voltage

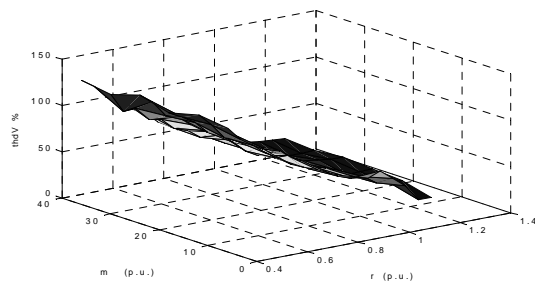

Fig.3 Harmonic spectrum voltage

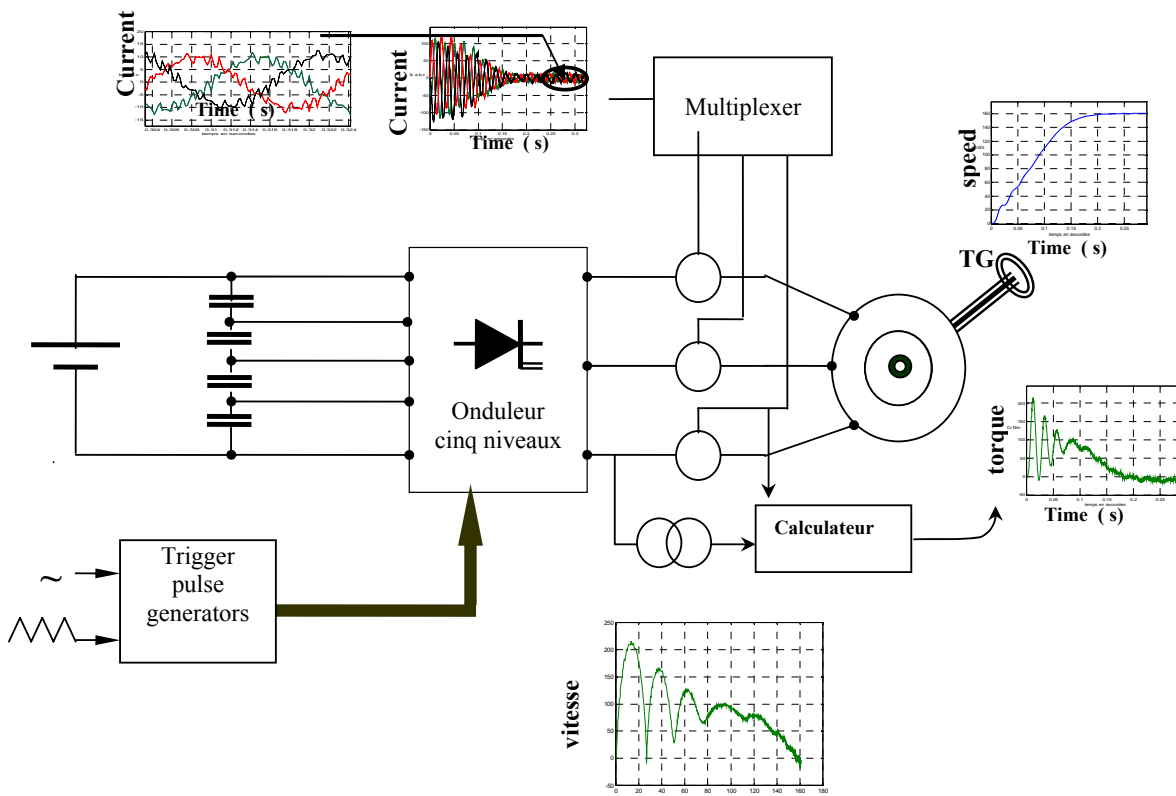

Fig.4 model simulation

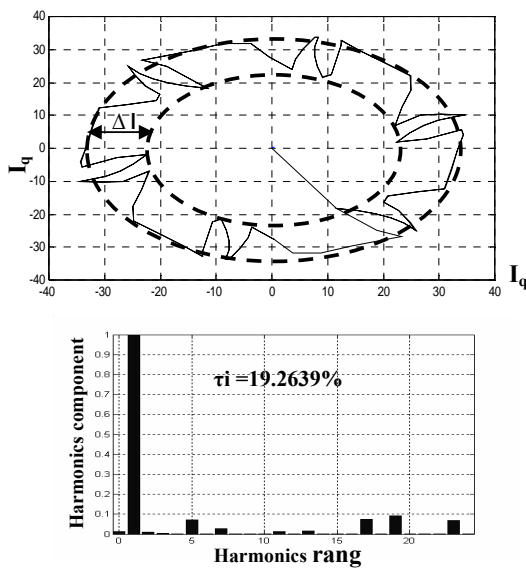

Fig.5 Current and corresponding harmonics delivered by five level inverter to an IM

The figure 6 is a very important representation because it informs us directly and clearly, about the harmonics content that is proportional to the thickness of the ring ΔI , which delimits the superior and lower values, since in sinusoidal

operation this one is perfectly circular or elliptic, according to the working mode of the load.

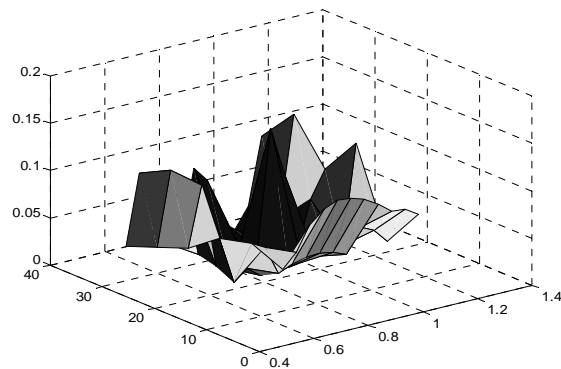

Fig. 6 Influence of the regulating indexes on speed oscillations of the IM rotor

The mechanical characteristics are also influenced by the variations of r and m fig.7, where the working without intolerable friction is delimited in the hatched domain that goes imposed us another restriction of r which depends on the technological process where the motor is submitted [11].

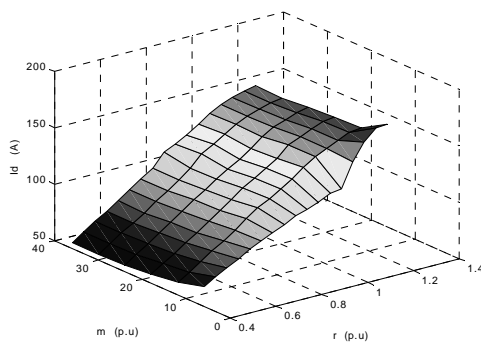

Fig. 7 Variation of the starting current of the IM according to r and m

IV. PROGRESSIVE STARTING & BRAKING

A. Starting of the large power engine

Sweet starting can be obtained with r control, for asynchronous machines of large power [1], beyond 100 kw the Y/Δ starting would be impossible, because of the strong commutation current, therefore one often uses the starting resistors, which reduces the efficiency and requires more space [11]. From where it is judged useful to orient these techniques toward the progressive starting that allows us more efficiency and flexibility fig.8 (adjustment of the starting time, and starting voltages if need be). According to fig.8 we show, that the dependence of I_d in relation with r is important from where the idea of the progressive starting.

B. Braking of heavier load

The principle of the progressive starting explained higher can be as well very useful in the starting that in the braking of the lifting facilities; whose brusque braking can cause some incidents engraves the side facilities and personal fig. 9, because the sudden stop of a load suspended by steel cables stimulates oscillations that risk either: the rupture of the cables, or the laxity of the load in free fall.

V. CONCLUSION

The operating mode of a five level inverter is limited in $[0,8: 0,95]$ for regulating index r and for modulation index m not passing 18 p.u., what corresponds well to the superior limits of the Gtos, currently marketable. The optimum for every inverter depends as well as r and m indexes, characterizing the law of control that the technological process in which the machine is submitted. So the control area given by r & m is limited according to the device sensitivity. Hence the excitation or the attenuation of frictions (whose tolerance depends on the load nature) can be adjusted by the simultaneous choice of r and m . The magnification of these frictions can be seen in different zones: the first peak corresponds to the weak values of m (Gtos operation) can be explained by the interference of harmonic currents. On the other hand the corresponding peak to the high values of m (transistors operation) doesn't have the same reason because the rate of harmonic is reduce, therefore, in this case, it brings closer the electromechanical resonance.

This study also allowed us to show as well the limits of five level converter supplying an asynchronous machine, that the influence of r , on the progressive starting, lifting heavy loads, can give economic and safety in industry works.

REFERENCES

- [1] S. Tamai, M. Koyama, T. Fujii, S. Mizoguchi, T. Kawabata "3 Level Gto Converter-Inverter Pair System for Large Capacity Induction Motor Drive" The European Power Electronics Association, pp. 45-50, 1993.
- [2] F Ben Ammar, L-O Peter-Contesse, M. Pietrzak-David, B. De Fornel "Power - Range Extension of an Induction Motor Speed Drive by Using a Three Level Gto Inverter With Space Vector Modulation" The European Power Electronics Association, pp. 219-223, 1993.
- [3] S. Halasz "Analysis of Pulse-Width Techniques for Induction Motor Drives" IEEE, pp. 200-204, 1993 [4] P. Enjeti, R. Jakkli "Optimal Power Control Strategies for Neutral Point Clamped (NPC) Inverter Topology" IEEE, pp. 924-930, 1989.
- [4] Jhi Sheng, Fang Zheng peng "Multilevel Converter - a New Breed of Power Converters" IEEE Transactions on Industry Applications Vol. 32. No. 3 May/June 1996, pp. 509-517.
- [5] Yo-Han Lee, Bum-Seok Suh, Dong-Seok Hyun "A Novel PWM Scheme for a Three - Level Voltage Source Inverter With Gto Thyristors" IEEE Transactions on Industry Applications Vol. 32. No. 2 March/April pp. 509-517, 1996.
- [6] Takafumi Maruyama, Masayochi Kumano, Masahiro Ashiya "A New Asynchronous PWM Method for a Three Level Inverter" IEEE, pp. 366-371, 1991.
- [7] Prasad N. Enjeti Phoivos D. Ziogas James F. Lindsay "Programmed PWM Techniques to Eliminate Harmonics: a Critical Evaluation" IEEE Transactions on Industry Applications Vol. 26. No. 2 March/April pp. 302-316, 1990.
- [8] A.M. Walkzyna "Reduction of Current Distortions of VSI-Fed Induction Machine Controlled by DSC - Generalized Approach" IEEE, pp. 457-462, 1993.
- [9] Joachim Holtz, Lothar Springob "Reduced Harmonics PWM Controlled Line - Side Converter for Electric Drive" IEEE Transactions on Industry Applications Vol. 29. No. 4, July/August, pp. 814-819, 1993.
- [10] Geza Joos, José Espinoza "A High Performance Voltage Regulated CSI AC Induction Motor Drive" IEEE, pp. 501-505, 1994.
- [11] R. Itoh "Stability of Induction Motor Drive Controlled by Current Source Inverter" IEE, Proceeding, vol. 136, Pt. B, No. 2, March 1989.
- [12] T. A. Noynad, H. Foch "Multilevel Converter: High Voltage Chopper and Voltage Source Inverters" IEEE PESC conf. Rec., pp. 397-403, 1992.
- [13] M. Carpita, S. Toconi "A novel Multilevel Structure for Voltage Source Inverter" proc. EPE Jpn., pp. 90-94, 1999.
- [14] V. T. Somasekhar, K. Gopakumar, M. R. Baiju, Krishna K. Mohapatra, and L. Umanand "A Multilevel Inverter System for an Induction Motor With Open-End Windings." IEEE TRANSACTIONS ON INDUSTRIAL ELECTRONICS, VOL. 52, NO. 3, JUNE, pp. 824-836, 2005.
- [15] Sergio Busquets-Monge, Josep Bordonau, Dushan Boroyevich, and Sergio Somavilla "The Nearest Three Virtual Space Vector PWM - A Modulation for the Comprehensive Neutral-Point Balancing in the Three-Level NPC Inverter" IEEE POWER ELECTRONICS LETTERS, VOL. 2, NO. 1, MARCH pp. 11-15, 2004.
- [16] J. Rodriguez, J. Lai, and F. Peng, "Multilevel inverters: A survey of topologies, controls and applications," IEEE Trans. Ind. Electron., vol. 49, pp. 724-738, Aug. 2002.
- [17] V. T. Somasekhar, K. Gopakumar, M. R. Baiju, Krishna K. Mohapatra and, L. Umanand "A Multilevel Inverter System for an Induction Motor With Open-End Windings" IEEE TRANSACTIONS ON INDUSTRIAL ELECTRONICS, VOL. 52, NO. 3, JUNE, pp. 824-836; 2005.