

# Wireless Distributed Load-Shedding Management System for Non-Emergency Cases

Taha Landolsi, A. R. Al-Ali, Tarik Ozkul, and Mohammad A. Al-Rousan

**Abstract**—In this paper, we present a cost-effective wireless distributed load shedding system for non-emergency scenarios. In power transformer locations where SCADA system cannot be used, the proposed solution provides a reasonable alternative that combines the use of microcontrollers and existing GSM infrastructure to send early warning SMS messages to users advising them to proactively reduce their power consumption before system capacity is reached and systematic power shutdown takes place.

A novel communication protocol and message set have been devised to handle the messaging between the transformer sites, where the microcontrollers are located and where the measurements take place, and the central processing site where the database server is hosted. Moreover, the system sends warning messages to the end-users mobile devices that are used as communication terminals. The system has been implemented and tested via different experimental results.

**Keywords**—Smart Grid, Load shedding, Demand Side Management, GSM Wireless Networks, SCADA systems.

## I. INTRODUCTION

**L**OAD shedding is a process in which electric power is cutoff on certain lines of power transformers when the demand approaches the system capacity. Load shedding is particularly important in isolated systems (islands of service) since there is no interconnected supply of power if the demand exceeds the power rating of the transformers. Typically load shedding is done by supervisory and monitoring systems such as supervisory control and data acquisition systems known as SCADA systems which continuously monitor vital parameters of the power system and decide when and how much load to shed. SCADA systems usually shed the appropriate power load keeping a well-balanced system and at the same time maintaining reasonable customer satisfaction.

In a typical load-shedding scheme, shown in Fig.1, a list of loads is used during the shedding process depending on a priority level attributed to the various customer loads. When there is an excessive load on the transformers, the SCADA system starts shedding the lowest priority load. This method of shedding is acceptable as long as the transformers are monitored by the central SCADA system.

T. Landolsi, A. R. Al-Ali\*, and T. Ozkul are with the American University of Sharjah, Box 26666 Sharjah, United Arab Emirates (Dr. Al-Ali is the corresponding author: phone: +971-515-2939; fax: +971-6-515-2979; e-mail: aali@aus.edu).

M. Al-Rousan is with Jordan University of Science and Technology, Jordan.

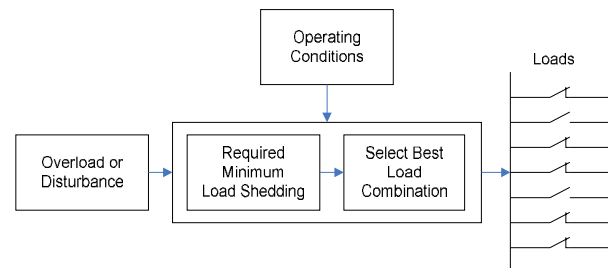

Fig. 1 Load-shedding strategy based on operating conditions and overload state

Remotely-located transformers, lacking SCADA connection cannot benefit from this scheme. Such transformers should have their own protection mechanisms for handling emergencies [1-3]. Load shedding in general has been studied extensively in the literature and adaptive strategies for Emergency Load-Shedding (ELS) circumstances in isolated systems, in particular, are studied in detail in [4-6].

In this paper we present a novel wireless-distributed load-shedding management system which is designed to handle remotely distributed transformers that are not connected to a SCADA system. The proposed system is designed for non-emergency cases and proactively involves users in the shedding process. Systems located in a hot climate zone, such as the emirates of Sharjah and Dubai of the United Arab Emirates, have many remotely-distributed transformers throughout the coverage area. During hot days, the peak power consumption is significantly higher than normal loads. Even though the power grid is designed to handle such peak loads, it is possible that spurious excessive demand may cause power shutdown. The IEEE Standard related to power transformers specifies that the normal temperature rise of the hottest spot must not exceed 80 °C over ambient temperature (ambient of 30 °C) [7]. This 110 °C limit is for continuous 24-hour-per-day conditions. The Guide states that temperatures as high as 180 °C are acceptable provided that the corresponding time period during a given 24-hour period is sufficiently short. For example, while 124 °C for 6 hours is acceptable, the time period for 180 °C has to be reduced to only 3 minutes.

Power companies in the area have been surveyed and expressed interest in practical load-shedding management systems which can be applied to remotely-located transformers [5]. In non-emergency cases, for which the proposed system is intended, power demand shows a predictable increasing trend.

Together with ambient temperature information, this could be leveraged to give enough lead time to take the necessary measures to avoid excess load and potentially massive power outages.

## II. NON-EMERGENCY LOAD-SHEDDING SCHEMES

Literature survey indicates that there are several methods used for non-Emergency Load-Shedding (non-ELS) sometimes referred to as Demand-Side Management (DSM) solutions. Demand side management (DSM) refers to any activity adopted by electric utility companies to reduce system demand by changing the pattern of energy consumption in order to solve several operational problems. In some cases utility companies try to educate the end users about the importance of using energy-efficient loads. DSM may involve giving incentives to consumers of electricity to reduce their energy usage by changing the electricity price according to the usage. Consumers of electricity, like consumers of all other commodities, will increase their demand up to the point where the marginal benefit they derive from the electricity is equal to the price they have to pay.

Reference [10] describes a secondary substation monitoring system which is cost-effective in load monitoring and fault detection on the distribution level of power networks. In the system, the supervision of vital parameters is done from a network control center (NCC). The large number of distributed monitoring devices described there, required a communication media that is easy to put in service with cost-effective infrastructure. The system has several communication possibilities including GSM communication. It uses the Short-Messaging System (SMS) feature of the General Packet Radio System (GPRS) modem to transfer all measurements from the proposed system to the NCC. The system monitors many parameters including overload conditions, power outages, under-voltage and over-voltage disturbance, earth faults, current unbalance, reactive power and temperature.

In another scheme presented in [2], the remote monitoring and control model allows the exchange of information across organizational boundaries, Internet Protocol (IP) networks and consolidates resources across company locations. This eliminates the need for staffing of multiple sites and commuting expenses between them. For single sites, it eliminates the common problem of being "resource-poor" when it comes to electrical engineering expertise. The study further discusses how advanced power quality meters with IP networking technology can also monitor transformer temperatures, breakers, and generators, while at the same time providing high levels of power analysis and a sequence of event recording.

Another system using wireless GSM is presented [3]. Some of its typical applications include:

- Power station monitoring and control.
- Liquid tank level and temperature monitoring.
- Geological and earthquake monitoring.
- Security system monitoring.

- Process monitoring using SMS.
- Supervisory control of water systems (measurement of water levels in rivers and dams).
- Remote control and monitoring of electricity transformers, high and low voltage cabins.

Another scheme is proposed in [11] where a central controller keeps track of energy consumption of the individual outputs and when the power consumption exceeds a predetermined threshold, a digital message is sent to digital controllers distributed in the field to cut off power to the circuits causing the overload.

## III. PROPOSED SYSTEM ARCHITECTURE AND OPERATION

The proposed system was designed to fulfill the following requirements:

- Contain a data collection module (DCM) at the physical location of the transformer to monitor, and record transformer load parameters.
- Contain a central processing module (CPM) at the server or control center site to keep records in a database.
- Integrate DCM, CPM and SMS in order to provide a reliable, automated, and cost-effective solution to the load management process.
- Use GPRS wireless modems and the SMS feature of GSM to communicate the state of transformers [12], [13].
- Consumers should be involved in the load shedding process.

### A. System Design

The designed system called Wireless Distributed Load-Shedding Management System (WDL-SMS) consists of three main modules as shown in Fig.2: The DCM, the wireless communication module, and the CPM. The DCM is installed at the physical location of the transformer site. It consists of a system status monitor, that continuously records and processes current on each feeder. It also consists of ambient and oil temperature sensors for the transformer.

The wireless communication module consists of a GPRS modem that sends SMS messages over the GSM network from the control center (CPM location) to the transformer site (DCM Site) and vice versa. This module is the communication backbone of the proposed system through which remote control and monitoring is achieved. It is integrated with the DCM at the transformer site and with the CPM at the control center. Off-the-shelf, cost-effective modems are used in the proposed WDL-SMS design.

In the network control center, the CPM processes the data, collected and fed-back by the GPRS modem at the transformer site, and sends control signals depending on the situations such as faults and overloads, or by special requests from authorized employees. A database is designed to hold all the records regarding transformers, feeders, and consumers.

**B. System Modes of Operation**

After consulting with engineers from local power companies, it was determined that the system should be configured to operate in two different modes: standard and caution modes according to the information gathered. In the standard mode the system sensors measure the current per feeder, oil temperature and the location temperature of the transformer every hour, and send an end-of-day SMS (Type-C) to the control center server.

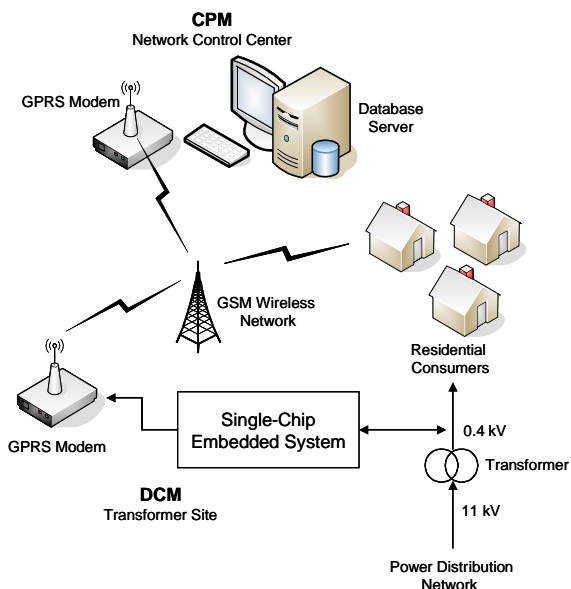

Fig. 2 System architecture showing the CPM, DCM with the GPRS modems and the GSM network

Type-C SMS contains transformer number, average current readings on all feeders, and oil and temperature readings of the transformer. If some readings are missing, the system requests them again from the DCM module. This Request SMS is called type-R SMS. In response to this request, type-C SMS messages are sent by the DCM. The purpose of these end-of-day SMS messages is to increase the reliability of data collection and to frequently update the database. In case of a physical fault at the transformers site, a type-B SMS message is sent to the server.

WDL-SMS will operate in caution mode if current loads on any of the transformer feeders exceed a specified preset values. A type-A overload SMS message will be sent to the server. The control center server then searches for respective consumers on that particular feeder inside its database. The server initiates "Overload" SMS messages to these consumers, asking them to reduce their power consumption. If the load is not reduced within a certain period of time called grace period, the control center asks the DCM at the transformers site to disconnect one or more feeders by sending Disconnect SMS.

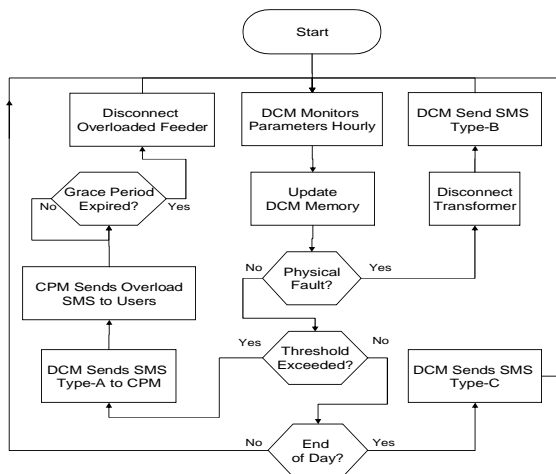

Fig. 3 WDL-SMS main algorithm showing the SMS messages and the respective actions that will be taken depending on the user response.

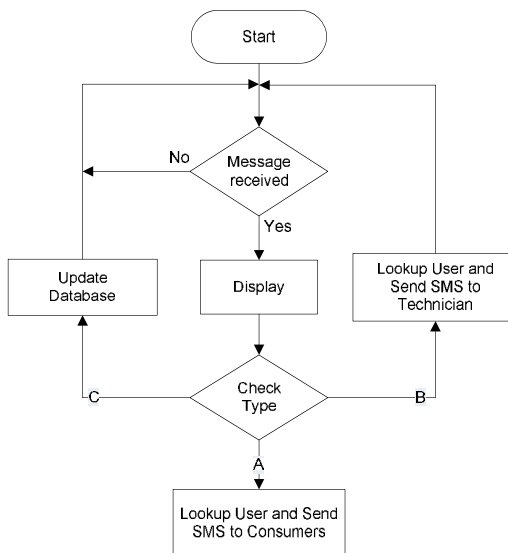

Fig. 3 Type A, B and C SMS messages algorithm

WDL-SMS also operates in caution mode if the oil and/or location temperatures of the transformer exceed some preset threshold values. For instance, for certain mineral oil-filled transformers [7], oil temperature approaching 140°C may cause explosion, although this temperature rise is usually due to transient faults such as short-circuits and not because of the steady-state increased transformer load. However, temperatures ranging between 95°C and 120°C will severely reduce the lifetime of the transformer and whenever this situation occurs it should trigger the fault SMS message (Type-B) from the DCM, and disconnect the transformer from the network. The trend analysis of the long-term log of data could be used to decide the best time for transformer upgrade. Fig. 3 describes the main algorithm used in WDL-SMS. It shows the SMS messages and the respective actions that will

be taken depending on the user response. Fig. 4 shows the algorithm followed to take different measures when receiving type A, B and C SMS messages.

IV. COMMUNICATION PROTOCOL

As the systems modules need to interact with each others during system operation, several communications messages are used between system modules. These messages include microcontroller-to-server, server-to-microcontroller, and server-to-consumer messages. This section discusses the messages and its associated types in details

A. Microcontroller-to-server Messages

Microcontroller messages are mainly used in reporting data from the DCM module to the server of the CPM module. Three types of messages are used including Alarm, Update, Fault, and Send-on-Request messages.

1) Alarm Message

Fig. 5 shows the message format of the Alarm message which consists of the following fields:

- Message Type: This field is one character long and specifies the type of the message. In this case the value of this field is 'A'.
- Transformer Number: A five-character field specifying the transformer number of the transformer from where the message is sent.
- Error Type: This field is one character long and specifies the type of error (overload) occurred. If the feeder is overloaded then its value is the feeder number. If the abnormality is due to excessive increase in ambient or oil temperatures, then its value is 'A' and 'O', respectively.
- Value: This three-character field holds either the reading of the feeder current or the temperature depending on the error type. If there is an overload in any feeder, then it holds the current value.
- X: This is one character space left to enable any future expansion in the characters of any field.

Message Type	X	Transformer Number	X	Error Type	X	Value
1 char	1 char	5 char	1 char	1 char	1 char	3 char

Fig. 5 Alarm message format

2) Update Message

Fig. 6 shows the message format of the Update message which consists of the following fields:

- Message Type: This field is one character long and specifies the type of the message. In this case the value of this field is 'B'.
- Transformer Number: A five-character field specifying the transformer number of the transformer from where the message is sent.
- Y field: It is composed of the following three fields:

- Feeder Number: This field holds the number of the feeder and is one character long. When the update is sent, the readings of all the feeders are sent in one message (at the end of the day).
- Average Current: A three-character field containing the average current of a feeder calculated throughout the whole day.
- Maximum Current: This field contains the maximum current reading recorded in the whole day. The length of this field is also three characters.
- X field: This is one character space left to enable any future expansion in the characters of any field.
- Z field is composed of the following three fields:
  - Temperature Sensor: A one-character field that indicates which temperature sensor's reading is being sent. 'O' is used if the temperature readings are of those of the oil.
  - Average Temperature: A three-character field containing the average temperature recorded from the sensor calculated throughout the whole day.
  - Maximum Current: This field contains the maximum temperature reading recorded in the whole day. The length of this field is also three characters.
  - X field: This is one character space left to enable any future expansion in the characters of any field.

Message Type	X	Transformer Number	X	Y Field	X	Z Field (Temp.)
1 char	1 char	5 char	1 char	5 char	1 char	5 char

Feeder Number	X	Current Reading	: Y Field
1 char	1 char	3 char	

Temp. Sensor No.	X	Current Reading	: Z Field
1 char	1 char	3 char	

Fig. 6 Update message format

3) Fault Message

This message has a simple format, as shown in Fig. 7, and contains the following fields:

- Message Type: This field is one character long and specifies the type of the message. In this case the value of this field is 'B'.
- Transformer Number: A five character field specifying the transformer number of the transformer from where the message is sent.
- X: This is one character space left to enable any future expansion in the characters of any field.

Message Type	X	Transformer Number	X
1 char	1 char	5 char	1 char

Fig. 7 Fault message format

4) Send-on-Request Message

Fig 8. shows the field of this message, it has the following fields:

- Message Type: This field is one character long and specifies the type of the message. In this case the value of this field is 'D'.
- Transformer Number: A five-character field specifying the transformer number of the transformer from where the message is sent.
- Y field: This field holds the number identifying the feeder and is one character long.
- Current Reading: A three-character field containing the current feeder current (I) read.
- X field: This is one character space left to enable any future expansion in the characters of any field.
- Z field: A one-character field that indicates which temperature sensor's reading is being sent. 'O' is used if the temperature readings are of the oil temperature.
- Current Reading: A three-character field containing the current temperature recorded from the sensor.
- X field: This is one character space left to enable any future expansion in the characters of any field.

Message Type	X	Transformer Number	X	Y Field	X	Z Field (Temp.)
1 char	1 char	5 char	1 char	5 char	1 char	5 char

Feeder Number	X	Current Reading	: Y Field
1 char	1 char	3 char	

Temp. Sensor No.	X	Current Reading	: Z Field
1 char	1 char	3 char	

Fig. 8 Send-on-Request message format.

B. Server-to-microcontroller Messages

The server communicates with the microcontroller using three different types of message: Request, Disconnect, and Connect. Here we briefly explain these messages (see Fig 9).

1) Request Message

Whenever the current readings of the transformer parameters are required by the utility site, a message of the above format is sent to the microcontroller.

2) Disconnect Message

This message format is sent to the microcontroller if the feeders are to be disconnected by the company. 'X' specifies the feeder number. The value of 'X' is 0 if all the feeders have

to be disconnected and if any particular feeder has to be disconnected then its number is sent as 'X'.

3) Connect Message

This message format is sent to the microcontroller if the feeders are to be reconnected by the company. 'X' specifies the feeder number. The value of 'X' is 0 if all the feeders have to be reconnected and if any particular feeder has to be reconnected then its number is sent as 'X'.

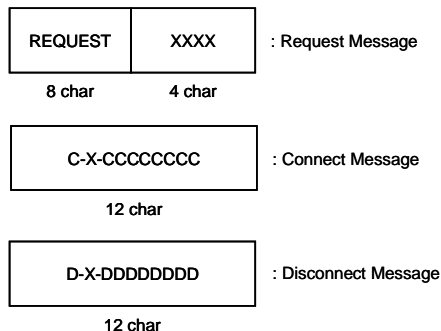

Fig. 9 Server-to-microcontroller messages format

C. Server-to-consumer Messages

In the event of excess power consumption, the consumer might receive the following alert message "Please reduce your power consumption or else you might suffer power loss. Thank you." as shown in Figure 10. This message consists of 65 ASCII characters totaling 455 bits per SMS message per alerted customer. Tables I and II summarize the various types of messages and their respective lengths.

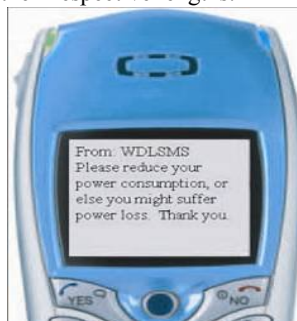

Fig. 10 Alert message sent from the server to the end user.

V. SYSTEM HARDWARE & SOFTWARE COMPONENTS

The Proposed system is designed and tested using two modules which contains necessary hardware and software. At the transformer site, the hardware module consists of an embedded system and a GPRS modem. Every transformer has eight feeders connected to the load, and each of these feeders is attached to the analog input channels of the embedded system through an analog switch. The GPRS modem is installed at the transformer site and is linked via RS-232 serial link to the embedded system. At the utility site, the hardware module is comprised of a server containing the database, and

another GPRS modem connected to the server.

TABLE I  
MESSAGES SENT FROM MICROCONTROLLER IN DCM SITE TO  
DATABASE SERVER IN CPM SITE

Message Type	Message Length (char.)
Alarm Msg.	13
Update Msg.	19
Fault Msg.	8
<b>Send-on-Request Msg.</b>	<b>19</b>

TABLE II  
MESSAGES SENT FROM DATABASE SERVER IN CPM SITE TO  
MICROCONTROLLER IN DCM SITE

Message Type	Message Length (char.)
Request Msg.	12
Connect Msg.	12
<b>Disconnect Msg.</b>	<b>12</b>

The software embedded in the transformer site continuously monitors the power and temperature changes of the feeders and reports any abnormality to the utility site through the GPRS modem.

The second module located at the utility site consists of software that receives the SMS from the transformer site and processes the information. The software also provides the administration with several functionalities such viewing stored readings, accessing the database, making changes to existing records, and finally generating a performance report. The software receives the message, checks its type and takes the necessary action as explained in the previous sections. The software module at the utility site also has a database which contains information about:

- Consumers;
- Transformer and their site location;
- Type of messages;
- Feeders and consumers connected to them;
- Technicians and their designated site;
- Parameter readings;

This software module is the one that sends messages to the customers, dispatches technicians to the site through the information contained in the database. Administrators can generate daily and weekly reports as needed using this software module.

## VI. TESTING PROCEDURES

WDL-SMS was tested under Standard and Caution modes. A prototype was designed and developed in order to simulate the loads, and operating environment of a typical transformer. However, some assumptions were made, and load for only four feeders per transformer was simulated. A hardware platform consisting of four relays each for one feeder, and four bulbs

indicating loads per feeder was connected to the Data Collection Module (DCM) and GPRS modem. Three or less bulbs lit per feeder indicated the WDL-SMS functioning in Standard mode. However, when all four bulbs were lit WDL-SMS, was seen to switch to Caution mode. Therefore, triggering an overload SMS, and hence waiting for consumers to decrease their power consumption. Temperature sensors were also attached to our prototype simulating real transformer's oil and substation temperature parameters. Temperature was increased using a Blow dryer, and transgression from Standard to Caution mode was observed. Fig.11 shows the experimental setup used in testing the WDL-SMS system.

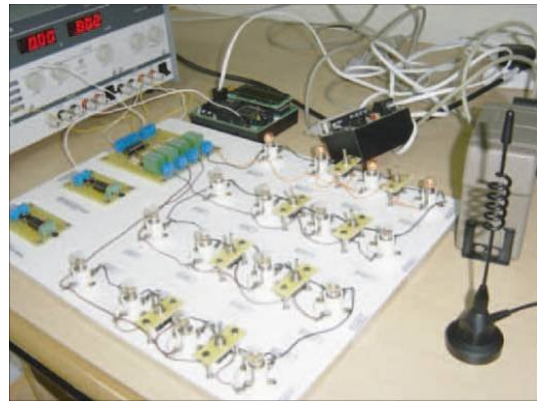

Fig. 11 Experimental setup for the WDL-SMS system.

## VII. COMMUNICATION SYSTEM DIMENSIONING AND PERFORMANCE

In this section, we propose to assess the impact of using WDL-SMS system on the DCM and CPM subsystems performance. The impact on the GSM network itself is expected to be minimal. Indeed, transmission of the SMS messages is done between the SMS center (SMSC) in the GSM operator's network and the customer mobile devices. It is usually done through the Signaling System number 7 (SS7) signaling protocol in which messages payload length is limited to 140 bytes or 1120 bits. This corresponds to either 160 7-bit ASCII characters, 140 8-bit Extended ASCII characters, or 70 16-bit Unicode characters. Characters in languages such as Arabic must be encoded using the 16-bit Unicode scheme. Messages larger than this must be segmented and carried over several payloads each having its appropriate overhead information. This situation will not occur in the current design since all WDL-SMS messages have smaller lengths than 1120 bits as indicated in Tables I and II. The longest message is the one sent from the database server in the CPM site to the end user and consists of 65 characters.

Dimensioning the memory for the CPM is more challenging than that of the DCM. In deed the DCM is only involved in processing the data of the local transformer whilst the CPM

subsystem is involved in receiving the data from all transformers equipped with WDL-SMS. This number could easily approach thousands. To carry out our dimensioning analysis we will consider the scenario of a system operating in caution mode where the current per feeder exceeds a certain threshold value in which type-A messages will be sent. This is indeed the worst case scenario since in standard mode parameters are read every hour and only sent once per day and do not increase the microcontroller and database server buffers and processors utilization.

When the current  $I$  exceeds the maximum threshold value  $I_{th}$  the messages exchanged are shown in Fig. 12. These reading values are encapsulated in the appropriate message, as explained in Section IV, and then the entire message is encapsulated in a protocol data unit (PDU) and transmitted by the modem over the air interface. Transfer data rates depend on the channel encoding used. A coding scheme called Coding Scheme 4 (CS-4) is used when the modem is near the GSM base transceiver substation while a coding scheme called Coding Scheme 1 (CS-1) is used when the modem is distant from the transceiver substation. Using the CS-4 it is possible to achieve a data transfer rate of 20 kbit/s for a given time slot. GSM technology uses Time Division Multiple Access (TDMA) with 8 time slots per frame hence supporting 8 simultaneous users at any given time. On the other hand, using CS-1 the system can only achieve a data transfer rate of 8 kbit/s per time slot.

To understand the possible impact of the GSM SMS messaging system various delays on the performance and lifetime of a given transformer equipped with WDL-SMS, we propose to use a model for a reliable communication link needed for data transfer over an unreliable wireless channel. In general network delays are composed of the aggregate of all nodal transmission, propagation, queuing, and processing delays. Reliability of data transfer implies using some form of automatic-repeat request (ARQ) protocol. If we assume the messages are small enough in size to fit into a single packet, Stop-and-and-Wait ARQ can be used since there will be no packet pipelining used (in which Go-back-N, or Selective Repeat ARQs are used). Under such assumptions, the significant delay incurred to correctly receive an SMS is given by the following equation:

$$Delay = \sum_i r_i \left[ \frac{M}{S_i} \right] \left( \frac{S_i}{R_b} + \tau_i \right). \quad (1)$$

Here, the summation is done over all packets where  $r_i$  is the number of retransmissions needed to correctly receive a given packet of the SMS message,  $M$  is the SMS message size in bits,  $S_i$  is the size of a given packet after SMS message packetization,  $R_b$  is the transmission bit rate (e.g. that is of CS-1 or CS-4), and  $\tau_i$  is the round-trip time for the  $i$ -th packet which is composed of the time to get the packet from a DCM to the CPM and to get a positive acknowledgement (ACK) for it from the CPM back to the DCM. The round-trip time,  $\tau_i$  is a

random variable that changes from packet to packet and that depends on the congestion state of the GSM network. Note that the packet size  $S_i$  is imposed by the link layer so that the alarm or alert message may fit entirely in one packet. In addition to this delay component, and because the WDL-SMS system will possibly be used by hundreds to thousands of transformers, it is necessary to take into account the queuing delays incurred at the CPM transmitter upon arrivals of alarm messages from the DCM as well as the queuing delay incurred at the CPM transmitter before transmitting the alert messages to end users.

We simulated a power network that has about 200 transformers equipped with WDL-SMS. We assumed that the arrivals of alarm messages from all the DCM to the CPM are Poisson-distributed, an assumption commonly made in several arrival processes, with an average arrivals rate of approximated  $\lambda = 75$  messages per second. This scenario is reasonable when the temperature is high and residential power consumption is at its peak during the "busy" hour of the power network. As shown in Table 1, the message size is fixed to 13 characters. If encoded in extended ASCII, each message will have 104 bits. End-to-end average delay (in minutes) for the alarm message only is shown in Fig. 13 for coding scheme CS-1. It is expected that for CS-4 coding scheme the delay would be smaller than that for CS-1. If the power network contains more than 75 WDL-SMS transformers than it is recommended that the CPM be distributed instead of centralized. In other words, the operators must ensure that each CPM does not handle more than 75 DCM or so. In the experimental testbed we implemented, the end-to-end time delay was between 0.1 to 10 seconds which is due to the small size of the testbed as compared to more realistic simulated power network.

## VIII. CONCLUSIONS

Wireless Distributed Load-Shedding Management System (WDL-SMS) was implemented and tested. It was verified to operate successfully under standard and caution modes. GSM network was successfully used in remote monitoring and control. Recent advances in the technology can be leveraged in order to make WDL-SMS more stable and feature-rich. The following are the future enhancements that could be added to the current proposed system:

- Upgrade to operate on the consumer level on each feeder of the transformer, rather than per feeder. This would provide more functionality, reliability and user-involvement to the system.
- An Artificial Neural Network (ANN) can be used in forecasting, or predicting overloads and abnormal conditions. ANN can be configured to recognize specific pattern or data classification, through a learning process.
- The system could call mobile technicians and use a pre-recorded voice to tell them about a fault rather than sending SMS. It can also email a summary of readings of all transformers to employees on a regular basis.
- WDL-SMS can be made to monitor record and update

transformer parameters more frequently.

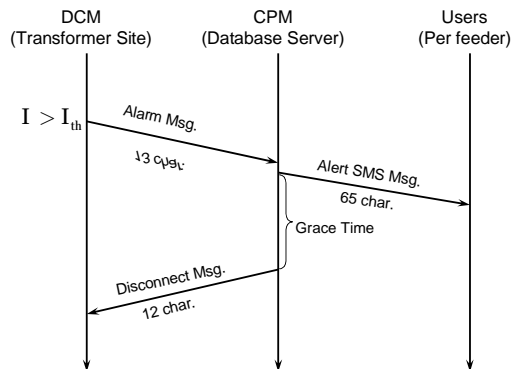

Fig. 12 Messages exchanged in the caution mode between the various WDL-SMS subsystems. Worst case scenario used for system performance and dimensioning.

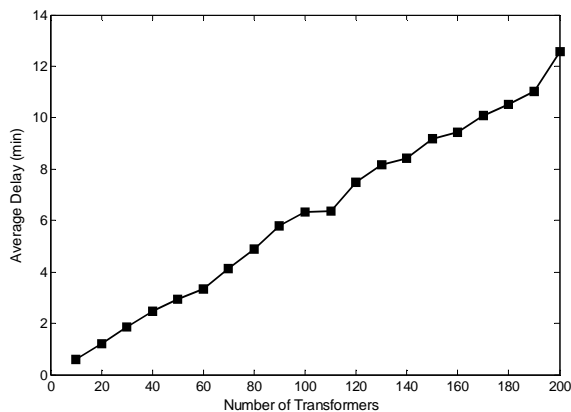

Fig. 13 Average delay for an end-user alert message as a function of the number of transformers in the system

#### ACKNOWLEDGMENT

The authors would like to acknowledge the support of their respective universities: The American University of Sharjah and Jordan University of Science and Technology.

#### REFERENCES

- [1] J.J. Ford, H. Bevrani, G. Ledwich, "Adaptive load shedding and regional protection", International Journal of Electrical Power & Energy Systems, Volume 31, Issue 10, November-December 2009, Pages 611-618.
- [2] F. Capitanescu, B. Otomega, H. Lefebvre, V. Sermanson, T. Van Cutsem, "Decentralized tap changer blocking and load shedding against voltage instability: Prospective tests on the RTE system, Electrical Power and Energy Systems, Vol 31, Issue 9, 2009, pp 570-576.
- [3] R. M. Maliszewski, R.D. Dunlop, and G. L. Wilson, "Frequency actuated load shedding and restoration Part I—philosophy", IEEE Transactions on Power Apparatus and Systems, vol. 90, no. 4, 1971, pp. 1452-1459.
- [4] A. Saffarian, M. Sanaye-pasand, H. Asadi, "Performance Investigation of New Combinational Load Shedding Schemes", Joint International Conference on Power System Technology and IEEE Power India Conference, 2008, pp 1 - 8.
- [5] A. A. Abou, A. Zein El-Din, S. R. Spea, S.R., "Optimal load shedding in power systems", Eleventh International Middle East Power Systems Conference, Volume 2, 2006, pp. 568 - 575.
- [6] S. J. Huang, and C. -C. Huang, "An adaptive load shedding method with time-based design for isolated power systems," International Journal of Electrical Power & Energy Systems, vol. 22, no. 1, January 2000, pp. 51-58.
- [7] IEEE, "Guide for loading mineral-oil-immersed transformers," IEEE Std. C57.91-1995.
- [8] D. S. Kirschen, "Demand-Side View of Electricity Markets" IEEE Trans on power system, vol. 18, No. 2, May 2003, pp.520-527.
- [9] C. M. Affonso, L. C. P. da Silva, and W. Freitas, "Demand-Side Management to Improve Power System Security", IEEE PES Transmission and Distribution Conference and Exhibition, 2005, pp. 517-522.
- [10] T. Leibfried, "Online monitor keeps transformer in service," in IEEE Computer Applications in Power, vol. 11, July 1998, pp.36-42.
- [11] W. Howe, T.S. Majewski, G.A. Kruse, "Method of load shedding to reduce the total power consumption of a load control system", United States Patent Application Publication, US 2009/0315400 A1, Dec. 24, 2009.
- [12] X. Jinqiu, X.Shumei, W. Guohe, "Monitor system of the intelligent power earth lines based on GSM SMS protocol", Electronic Measurement & Instruments, 2009. ICEMI '09. 9th International Conference on, pp. 3-178 - 3-181.
- [13] Chen Peijiang Jiang Xuehua, "Design and Implementation of Remote Monitoring System Based on GSM", Pacific-Asia Workshop on Computational Intelligence and Industrial Application, 2008. pp. 678 - 681.
- [14] Transformer Mineral Oil handbook, Nynas Naphthenics. Available on URL: <http://www.nynas.com>.
- [15] J. H. Ahrens, U. Dieter, "Computer Generation of Poisson Deviates". ACM Transactions on Mathematical Software, vol. 8, no. 2, 1982, pp.163-179.
- [16] D. C. Montgomery, and G. C. Runger, Applied Statistics and Probability for Engineers, John Wiley, 2007.

**T. Landolsi** received his Ph.D. from the University of Texas at Dallas, USA, in 1999. He worked in the telecommunications industry for more than seven years designing and planning wireless and optical networks. He is currently an Assistant Professor of Computer Engineering at the American University of Sharjah, UAE. His research interests include: wireless and optical networks, optical switching and computing, wavelet transforms applications to communications and signal processing, and MEMS applications.

**A. R. Al-Ali** received his Ph.D. from Vanderbilt University, USA, in 1990. Currently, he is a Professor of Computer Engineering at the American University of Sharjah, UAE. His research and teaching interests include: Embedded systems, microprocessors and microcontrollers, microcomputers, data acquisition units and PLC hardware and software architectures, remote monitoring and control using Internet, GSM, and GPRS networks.

**T. Ozkul** received his Ph.D. in Electrical Engineering from Florida Institute of Technology, Florida, USA, in 1988. He worked in academia and industry in different capacities from design engineer to CEO. His industrial experience was mainly in medical electronics industry manufacturing state-of-the-art high-tech medical and industrial equipment. He is currently working as an Associate Professor in the Department of Computer Engineering at the American University of Sharjah.

**M. Al-Rousan** M. Al-Rousan received his Ph.D. from Brigham Young University, USA in 1996. He is Currently an Associate Professor of Computer Engineering and the Dean of the College of Information Technology at Jordan University of Science and Technology. His research interest includes wireless networking, computer applications, intelligent systems, and Internet computing.