

GPS and Discrete Kalman Filter for Indoor Robot Navigation

Mbaitiga Zacharie

Abstract—This paper discusses the implementation of the Kalman Filter along with the Global Positioning System (GPS) for indoor robot navigation. Two dimensional coordinates is used for the map building, and refers to the global coordinate which is attached to the reference landmark for position and direction information the robot gets. The Discrete Kalman Filter is used to estimate the robot position, project the estimated current state ahead in time through *time update* and adjust the projected estimated state by an actual measurement at that time via the *measurement update*. The navigation test has been performed and has been found to be robust.

Keywords—Global positioning System, kalman filter, robot navigation.

I. INTRODUCTION

NAVIGATION can be defined as a process of maintaining a trajectory to a goal distance. Each of us conducts some form of navigation in our daily lives. Such as driving to work, walking to a store requires that we employ fundamental navigation skills. For most of us, these skills require using our eyes, common sense and landmarks. However in some cases where a more accurate knowledge of our position, intended course, or transit time to a desired destination is required, navigation aids other than landmarks are used. These may be in different form of a simple clock to determine the velocity over a known distance in our car to keep of the distance traveled. In the animal kingdom, such as homing pigeons, they are able to find their way home when released large distance away, even if they have been carried there in covered cages. Since they cannot see the path that has been taken from home to where they are released, they cannot store it in any way; nor can they see landmark along away. It has postulated that these birds employ a navigation map by using naturally occurring gradients in the earth's magnetic field. In effect, this means that their magnetic compass is sensitive not to the polarity of the earth's magnetic field, but to its inclination with respect to the local gravity vector. This has been demonstrated by observation of birds flying over the equator. The pigeons combine this gradient information, which gives them a gross direction from the release point with a memory of landmarks near their home base. In addition to homing pigeons, a number of other animals migrate long distances. The return of salmon to the stream where they were born, after several years of swimming in the ocean, is an amazing phenomenon. Magneto-sensors have been identified in trout and perhaps salmon as well. Marine animal, like whales,

also migrate long distance. Some terrestrial mammals also travel long distances, and some like caribou, do so over terrain with relatively fewer landmarks than, say, those that live in a more temperate climate. Elephants are reputed to be able to navigate to the burial ground from long distances. These quick examples show us that animals possess a variety of remarkable abilities to assist them in navigation. If animals rely on some form of navigation to help them travel along distance it means that, navigation is not an easy task to deal with and for a robot to keep track of its distance traveled to a goal, like human and animals; it needs some form of navigation aid as well; hence the Global Positioning System (GPS). The GPS is the best one to use as it provides the position, velocity, and timing information that can enable the robot as well the user to control the robot path tracking. A GPS that its accuracy has improved significantly in the past few years has been developed by several US government organizations, including the Department of Defense (DOD), the National Aeronautics and Space Administration (NASA), and Department of Transport (DOT) in the early 1960, for military purposes. The satellite constellation consists of 24 satellites arranged in 6 orbital planes with 4 satellites per plane. A worldwide ground control-monitoring network monitors the health and status of the satellites. They are five GPS stations around the world: Ascension Island, Hawaii, Diego Garcia, Kwajalein and Colorado Spring monitoring the GPS satellites, checking both their operational functions and their exact position in space. Ascension Island, is an isolated volcanic island in the equatorial waters of the South Atlantic Ocean around 1,600 kilometers (994 miles) from the coast of Africa, and 2,250 kilometers (1,398 miles) from the coast of South America which is roughly midway between the horn of South America and Africa. The GPS receiver calculates its position by a technique called satellite ranging which involves measurement the distance between the GPS receiver and the GPS satellite it is tracking. The distance is measured as the elapsed transit time. Ever since GPS was first conceived, it was envisaged that receivers would be used for positioning in motor vehicles. By the early 1990s, GPS receiver technology had advanced to the point where GPS products functioned reliably in automotive environment and cost had dropped to a point widespread use was possible. GPS is now used in automotive systems for navigation aid, in robot for navigation assistance.

II. PREVIOUS WORK ON GPS

Before the GPS was made available to anyone wanting to use it, the robot navigation was mostly based on vision by using a

Mbaitiga Zacharie is with the Department of Media Information Engineering, Okinawa National College of Technology, Nago-city, 905 Henoko Okinawa, Japan (e-mail: zacharie@okinawa-ct.ac.jp)

CCD camera along all sorts of sensors available on the market to enable the robot to see and recognize landmarks such as rocks, trees and so on. Vision sensors are the eyes of the robot. But in the last few years, the use of CCD camera has decreased considerably as most of robot developers have shifted their preference toward complementary metal oxide semiconductor (CMOS) camera for low price reasons for some. While other claimed that the CMOS camera is better than CCD camera, although both types of images convert light into electric charge and process it into electronic signals, and neither is categorically superior to the other. But with the advent of GPS, the number of engineers and scientists working on the application of GPS increases rapidly for the following reasons:

- GPS provides a service to an unlimited number of users since the user receiver operates passively.
- The navigation data provide the means for the receiver to determine the location.
- GPS provides the capability for determining three-dimensional user velocity, which is denoted x . Several methods can be used to determine the user velocity. In some receivers, velocity is estimated by forming an approximate derivative of the user position as follows:

$$\dot{x} = \frac{dx}{dt} = \frac{x(t_2) - x(t_1)}{t_2 - t_1} \quad (1)$$

This approach can be satisfactory provided user's velocity is nearly constant over the selected time arrival and that the errors in the positions $x(t_2)$ and are small relative to difference $x(t_2) - x(t_1)$.

- GPS utilizes the concept of Time of Arrival (TOA) ranging to determine user position. This concept entails measuring the time it takes for a signal transmitted by an emitter at a known location to reach a receiver. This time interval is then multiplied by the speed of the signal to obtain the emitter-to-receiver distance. By measuring the propagation time of signal broadcast from multiple emitters at know locations, the receiver can determine its position.

Due to the above mentioned reasons (only a few among dozens) GPS has become an excellent sensor to deal with the navigation problem as for example: In [1] the author proposes an autonomous robot navigation based on OpenStreetMap Geodata, where in the localization method, they use a combination of GPS and laser inspired by the work of [2] and the method consists of two steps: in the first step, each received GPS position where the Kalman Filtered with wheel odometry and inertial measurement data. In the second step, the Kalman filtered GPS is integrated into a Monte Carlo localization that estimates the posteriori belief distribution of a robot's pose based on sensor data of motion and a given mat of the environment. [3] Introduces an application of the GPS system on a mobile robot for the International Ground Robotics Contest

navigation where five fixed base points are set as the target position, which is about 100 yards apart between each other. Then the GPS is used to get the original position, and then tracking is used to move the robot itself from one point to the next, updating the new bas with every pass. The Comparison of Data Fusion Techniques for Robot Navigation is the research topic of [4]. The author system obtains the measurement position from GPS, which are fed into fuzzy system, where the data fusion occurs. And where the shortest distance is preferred than the longer as it is corrupted lesser. [5] Deals with the indoor GPS receiver for Mobile Robot. In this proposed method, the mobile robot position is calculated from triple difference of carrier phase, and the GPS used was differential GPS. In [6] a simple Ultrasonic Sensor GPS System for indoor Robot using the linear Kalman Filter is also proposed. The system uses two coordinates (x, y), where the distance of the robot is obtained in the receivers with the RF (Radial Function) signal from the transmitter. This distance is calculated using trigonometrically functions and the linear Kalman Filter is then used to correct the noise from the ultrasonic GPS.

III. SYSTEM OVERVIEW

A. Robot type

The robot used in this experiment shown in Fig.1 is a prestige robot with a rugged wheeled Wi-Fi equipped with two gripping arms that optionally provide the robot with one wrist-mounted complementary metal-oxide semiconductor (CMOS) camera installed on its right arm.

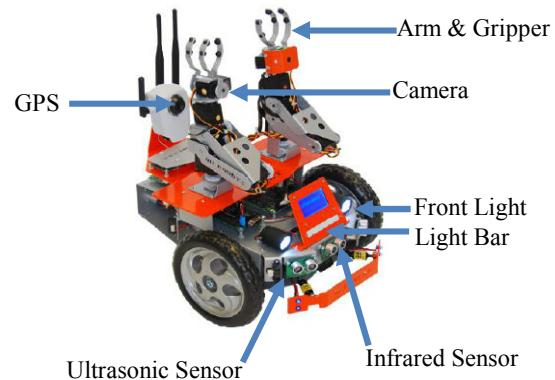

Fig. 1 Multi-DOF gripping arm robot

Combining mobility and a new ability to grasp and manipulate, the robot offers users broad versatility in its application. The wheels-based platform consists of 12V DC motors with integrated 800 counts per cycle optical encoder, yielding a top speed of 0.75ms^{-1} . The robot is light as it weights only 4kg with a capability to carry a maximum payload of 15 kg. Concerning the sensor types, the robot comes with ultrasonic range sensors and infrared range sensors including two-way audio capability. These range sensors are for environment detection and collision avoidance, while the two-way audio is for communication between the robot and the user. The

collision avoidance and the sensing may not be corrected by information acquired from the only vision, therefore three ultrasonic sensors, with one located at the middle front bottom, one in the left front bottom hand side and one on the right front bottom hand side of the robot are integrated. The middle front sensor is used for detecting obstacle, while those on each side are used for assisting the six infrared sensors of which one is located at the middle front upper just above the middle front bottom of the ultrasonic sensor, one in the upper front left, one in the upper front right, one in the rear middle, one in the rear left and one in the rear right of the robot respectively. Two quadrature encoders are also integrated in the robot, where the left one uses the channel-1 and the right one uses the channel-2. DC servomotor is used to steer and driving of the prestige robot.

B. GPS and landmark specification

The GPS use in this study is a unique sensor system for indoor localization of intelligent mobile robots. It analyzes infrared ray image which is reflected from a passive landmark of type D1-L with an independent ID as shown in Fig.2.

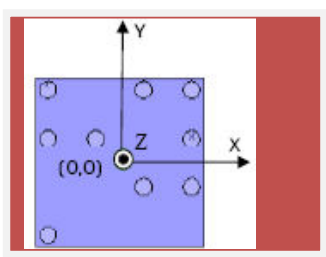

Fig. 2 Reference landmark

The output of position and heading angle of a robot is given with very precise resolution and high speed. This heading angle is 10 degrees and repetitive precision of 2cm. The localization range per landmark is 2.5~3 m in diameter. The total landmark is 4,095ea with a combination of 4x4. It is seldom affected by surroundings such as an infrared ray, a fluorescent light and sunshine. The communication protocol is based on ASCII code, a measurement time of 20 times per second. The hardware interface type is UAR115.200bps and the power consumption is: 5v for 300Am and 12V for 70Am respectively. Fig.3 and Fig.4 show the landmark ID coding and X, Y coordinates, and an illustration showing how our GPS works.

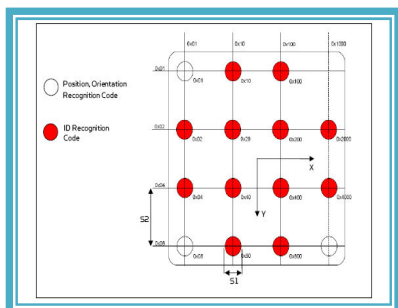

Fig. 3 Landmark ID coding

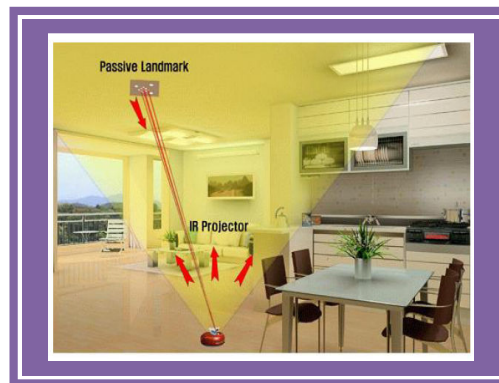

Fig. 4 Illustration showing how our GPS works

IV. APPROACH

A. The mapping notion

The core to all navigation and positioning tasks is the notion that a map is a little value without reference to recognizable characteristics of the surface of the earth. A simple example is as follows: a ship's captain may know where the vessel is and have the coordinates of the journey's end, but in order to navigate the route safely, the location of potential dangers must be known, as well as of ports of haven, designed shipping lanes, restricted waters. In the case of a land vehicle the coordinates of the vehicle's present location or of the destination may be little of use to the average driver who is not expected to be trained in traditional navigation skill, and may probably be largely ignorant of mathematical coordinate systems. The driver would prefer locations to be expected in terms of an address, for example a street name. The road map is a compact, graphical representation of the essential special information that a driver needs to negotiate a journey to a new location and, in the context of the Intelligent Transport Systems (ITS), is the interface between the driver and the positioning technology being used and so do for robot too.

B. Landmark ID and co-ordinations

In the propose system, we start first by building the landmark map by placing on the ceiling of 2.5 m high the landmarks with the following IDs shown in table 1 at 2 m intervals in order that any dead zone may not occur.

TABLE I
SAMPLE LANDMARK CODE NUMBER

1284	1812
1286	1814
1298	1824
1300	1826
1798	1828
1804	1830
1810	1840

Two dimensional coordinates is used for the map building, and refers to the global coordinate which is attached to the reference landmark for position and direction information the robot will get. The position and direction data for path planning are the center of the robot which is the midpoint along the wheel axis with respect to the global coordinate. When the robot heading aligns with the X axis of the global coordinate, the direction we will get should be equal to 0 degree ($Dir = 0^\circ$). And when the robot heading aligns with the Y axis of the global coordinate, the direction we will get should be equal to 90 degrees ($Dir = 90^\circ$) and the right-hand coordinate is adopted. The difference between our system and the previous work on GPS robot control in the open literature is that, in the previous work the robot must rely only on the GPS position information. But in our system we set two sets of positions, one for the GPS and another one for the robot as follows:

$$\begin{bmatrix} GPS_{position} \\ Robot_{position} \end{bmatrix} = \begin{bmatrix} P_{X-GPS}, P_{Y-GPS}, Dir_{GPS} \\ P_{X-robot}, P_{Y-robot}, Dir_{robot} \end{bmatrix} \quad (2)$$

Where:

P_{XGPS} = GPS X- position in meter.

P_{YGPS} = GPS Y- position in meter.

Dir_{GPS} = GPS direction in degree.

P_{XRobot} = Robot X- position in meter.

P_{YRobot} = Robot Y- position in meter.

Dir_{Robot} = Robot direction in degree.

The heading direction of the GPS sensors is in the opposite of the robot heading and the distance between the center of the GPS sensor and the robot is 0.135 m. The positive rotation direction of the GPS sensor is in clockwise around the Z axis while the positive rotation of the robot is in counter clockwise around the Z axis. Fig.5 shows the global coordinate.

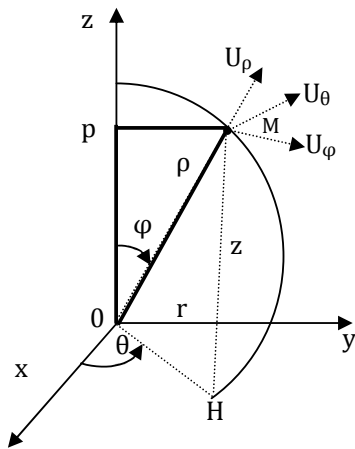

Fig. 5 Global coordinates

where

Radius: $\rho = OM$

Azimuth: $\theta = (U_x, OH)$

Colatitude: $\varphi = (U_x, U_\rho) = 90^\circ - \delta$ (δ = latitude)

The relationship between the GPS direction θ_{GPS} and the robot direction θ_{robot} is:

$$\theta_{robot} = 180 - \theta_{GPS} \quad \text{if } \theta_{GPS} \in (0, 180) \quad (3)$$

$$\theta_{robot} = -180 - \theta_{GPS} \quad \text{if } \theta_{GPS} \in (-180, 0) \quad (4)$$

Hence

$$\begin{bmatrix} X_{robot} \\ Y_{robot} \end{bmatrix} = \begin{bmatrix} 0.126 * \cos(\theta_{robot}) + X_{GPS} \\ 0.126 * \sin(\theta_{robot}) + Y_{GPS} \end{bmatrix} \quad (5)$$

C. Kalman filter algorithm

In the field of robotics and in all moving robots either a mobile robot or industrial robots, there are some parameters that are influenced by noises. Sometimes, these unobserved noises can prevent the system to work or to navigate as expected or shorten the system life span. To correct or simply eliminate these noises over the system, a robust control system is no doubt compulsory and the one we found the best is the Kalman filter compare to Wiener filter for this job. Because the Kalman filter addresses the problem of estimating the state of a discrete-time controlled process that is commanded by the linear difference equation with a measurement. The significance of this filter is in its ability to accommodate the vector signals and noises which may be non-stationary. The solution is recursive in that each update estimate of the state is computed from the previous estimate and the new input data, so, contrary to Wiener filter, only the previous estimate requires storage, so Kalman filter eliminates the need for storing the entire pass observed data as well as measurement. For this system the robot receives first its position and direction information from the GPS sensor, based on the global coordinate. The Kalman filter task is to estimate if the information receives from the GPS is correct or not by using the robot own position and direction information as our system has two sets of information position and direction mentioned in the previous section. The following two sets of equation are used by taking into consideration the linearization of the system about the estimate state x_k and the control signal u_k

- Time update equation.

$$x_{k+1} = Cx_k + Du_k + \Delta_k \quad (6)$$

- Measurement update equation.

$$z_k = Ex_k + v_k \tag{7}$$

Where:

x_k = state of the system or state vector.

C = 2x2 coefficient matrix of x_k .

$$\text{and is: } \begin{bmatrix} 0.5 & 0.7 \\ 0.8 & 0.9 \end{bmatrix}$$

D = 2x2 coefficient matrix of x_k .

$$\text{and is: } \begin{bmatrix} 0.1 & 0.4 \\ 0.8 & 0.2 \end{bmatrix}$$

E = 2x2 coefficient matrix of x_k for z_k .

$$\text{and is: } \begin{bmatrix} 0.9 & 0.3 \\ 0.9 & 0.5 \end{bmatrix}$$

z_k = observed vector.

The variable v_k and Δ_k are chosen randomly and represent the process and measurement noise. We consider them to be white and independent with three normal probabilities distribution as follows:

- First we compute the probability of an outcome favoring either the process noise or measurement. This probability is defined as:

$$P(\Delta_k \cup v_k) \sim N(0, \rho) + N(0, \mu) \tag{8}$$

- Second, we defined if the probability of two outcomes is independent, then the probability of both occurring should be the product of their individual probability.

$$P(\Delta_k \cap v_k) \sim N(0, \rho) \cdot N(0, \mu) \tag{9}$$

- Then finally, we compute the probability of an outcome ρ given an occurrence of outcome μ using the conditional probability of ρ given μ as follows:

$$P(\Delta_k / v_k) = \frac{N(\Delta_k \cap v_k)}{N(0, \mu)} \tag{10}$$

Where:

ρ = process noise covariance matrix.

μ = process measurement noise matrix.

The random variable is essentially a function that maps all points in the simple space to real numbers. In our filter, the two random variable map time to position and at any time they tell us the exact expected position of the robot coming from the GPS sensor.

Next, we defined $\hat{e}_{m+\alpha} \in \mathfrak{R}^n$ as a priori state estimate at step $m + \alpha$ knowing the process prior to step $m + \alpha$ and $\hat{e}_{m+\alpha} \in \mathfrak{R}^n$ which is the system a posteriori state estimate at step $m + \alpha$ for the observed vector z_k . We compute the a posteriori state estimate $\hat{e}_{m+\alpha}$ as a linear combination of a priori $\hat{e}_{m+\alpha}$ and weighted the difference between an actual observed vector z_k and measurement prediction $A \hat{e}_{m+\alpha}$ (11).

$$\hat{e}_{m+\alpha} = \hat{e}_{m+\alpha} + K(z_k - A \hat{e}_{m+\alpha}) \tag{11}$$

Where:

K = Kalman gain and is defined as:

$$K_P = \frac{P_k H^T}{HP_k H^T + R} \tag{12}$$

H = 2 x 2 coefficient matrix of P_k .

A = 2 x 2 coefficient matrix of $\hat{e}_{m+\alpha}$ measurement innovation.

The measurement innovation is the discrepancy between the predicted $\hat{e}_{m+\alpha}$ and the actual observed vector z_k . The ongoing GPS and Kalman filter is shown in Fig.6.

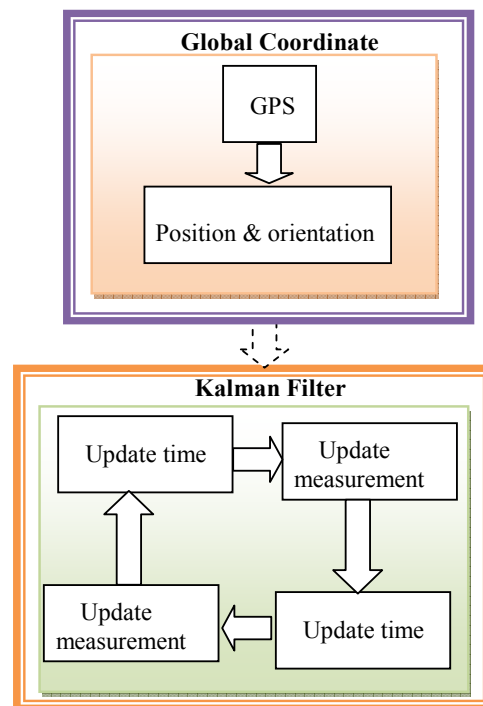

Fig. 6 The ongoing Discrete Kalman filter cycle

V. EXPERIMENTAL RESULTS

To validate our system, the experimental test is performed in the corridor of about 250 m starting from the Department of Media Information Engineering to the Department of Mechanical System Engineering on the second floor of the invention production buildings of our school. The program is written in C# with Visual Studio 2008 under .Net3.5. The localization system consists of the localization GPS sensor on the robot which is robust to the disturbances from environment lighting such as sunshine or fluorescent lights and the passive landmark mounted on the ceiling. The landmark is made of a material that strongly reflects infrared ray. Coding on each landmark differentiates landmark one from the other. The localization GPS sensor is composed of both IR projector and an image processing unit. It analyzes the infrared image which is reflected from different ID given passive landmarks on the ceiling. The range from the sensor to the landmarks on the ceiling is automatically measured and calibrate. The relative position and direction relationship between two landmarks is also automatically measured and calibrate through the landmark mapping procedure during landmark setup. We begin first by mounting the following landmarks, 1284, 1286, 1298, 1300, 1218 on the ceiling and sets the landmark 1300 as the landmark reference, then move the robot under the landmark 1300, so that the origin of the global coordinate is under this landmark. When the landmark is seen "parameterUpdate" is received and the GPS sensor automatically switches to map mode and return the position and orientation reading (x,y,θ). The "CalcData" window display the data string "x|y|θ" in normal localization mode. The first position and orientation received was (1.5, 18, 89°). Table II and table III show the GPS and robot orientation in degree and radians.

The parameters used during the test performance are:

- Linear velocity $v = 0.60$ m/s.
- Angular velocity $\omega = 0.4$ rad/s.
- The orientation angle of the GPS varies from 90° to 82° or around 1.57 to 1.43 rad.
- The orientation angle of the robot varies from 94° to 90° or around 1.64 to 1.57 rad. The results are shown as:

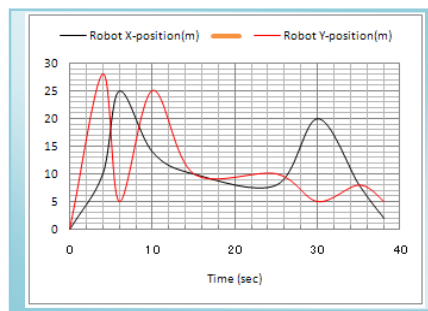

Fig. 7 Robot X and Y positions

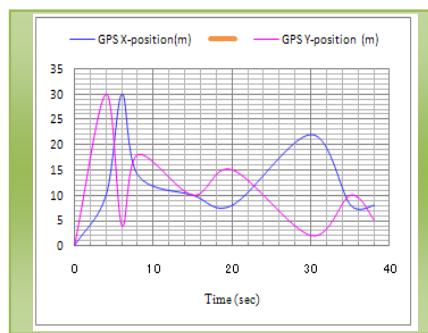

Fig. 8 GPS X and Y positions

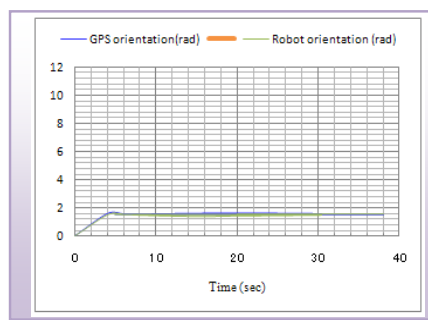

Fig. 9 GPS and Robot orientation.

TABLE II
GPS ORIENTAION DURING NAVIGATION

Degree	Radian
87	1.51
89	1.55
85	1.58
82	1.43
85	1.50
86	1.53

TABLE III
ROBOT ORIENTATION DURING NAVIGATION

Degree	Radian
92	1.60
91	1.58
90	1.57
93	1.62
94	1.64
89	1.55

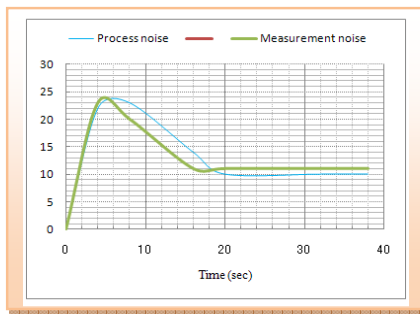

Fig. 10 Process and measurement noise

In Fig.7 and Fig.8, from the base station, at exactly 4 seconds time frame the robot X position and the GPS X position we received are 28 m (orange curve) and 30 m (pink curve), and the robot Y position and the GPS Y position are 25m (black curve) and 30 m (blue curve) at 6 seconds respectively, proving how fine our system works. While in Fig.9 the GPS orientation (blue curve) and the robot orientation (green curve) are represented. These two curves are almost too close to distinguish from one another. The curve (light blue) and the curve (green) shown in Fig.10 are the process and the measurement noise. These noises are the same type of noise where they stabilize at about 18 seconds time frame and remain constant until the robot gets to its goal. In our previous work [7], only the process noise stabilizes at around 49 seconds and remains constant throughout the rest of the robot journey, but the measurement noise did not. So we can say that our filter has performed very well as the the stabilization time of the process noise and measurement noise is reduced from 49 second to 18 seconds.

VI. EXPERIMENTAL RESULTS

This paper discusses the implementation of the GPS and the Discrete Kalman filter for indoor robot whose two dimensional coordinates is used for the map building, and refers to the global coordinate which is attached to the reference landmark for position and direction information the robot gets. The process and measurement noise variable are chosen randomly and consider them to be white and independent with three normal probability distribution. The relative position and direction relationship between two landmarks is automatically measured and calibrate.

REFERENCES

- [1] M. Hentschel and B. Wagner. "Autonomous Robot Navigation Based on AopenStreetMap Geodata". Proceedings of the e 13 th Intelligent IEEE Conference on Intelligent System, pp: 1645-1650, DOI: 10.1109/ITSC.2010.5625022, 2010.
- [2] M. Hentschel, O. Wulf and B.Wagner. "A GPS and Laser-based Localization for Urban and Non-Urban Outdoor Environments". IEEE/RSJ International Conference on Intelligent Robots and Systems (IROS), pp: 149-154, Nive, France, 2008.
- [3] P.Cao, M. Saxena, M. Tedder, S.Michalske and E.L.Hall. "An Application of GPS Systems on a Mobile Robot". <http://www.min.uc.edu/robotics/papers/paper2001/Peter2001e.pdf>.
- [4] N. Kyriakoulis, A.Gasteratos and A.Amanatiadis. "Comparison of Data Techniques for robot Navigation". Proceedings of the 4th Hellenic International on Advanced in Artificial Intelligence, pp: 547-550, 2006.
- [5] H. Niwa, K. Kogdaka, Y.Skamoto and S. Shigeki. "Indoor GPS Receiver for Mobile Robot". Proceedings of the KSAE Fall Conference, Branch of. Busan-Ulsan Gyeongnam, pp:95-102, 2003.
- [6] D.Kim, K.Hwang, D.Lee and T.kue. "A Simple Ultrasonic GPS System for Indoor Robot System using Kalman Filter".Proceesings of the International joint Conference SICE-ICASE, pp: 2915-2918,DOI: 10.1109/SICE.2006.314996
- [7] Z. Mbaïtiga. "Sensor Fusion Based Discrete Kalman Filter for outdoor Robot Navigation".International Conference on Control, Automation and robotics(ICCAR'11), Paris, France, August 24-26,2011.
- [8] Z. Mbaïtiga. "Adaptive Fuzzy Knowledge Based Controller for Autonomous Robot Motion Control". Journal of Computer Science Vol.6, Issue10, pp: 1048-1055, 2010, Science Publications, New York, USA.