

Ultra Fast Solid State Ground Fault Isolator

I Made Darmayuda, Zhou Jun, Krishna Mainali, Simon Ng Sheung Yan, Saisundar S, Eran Ofek

Abstract—Personnel protection devices are cardinal in safety hazard applications. They are widely used in home, office and in industry environments to reduce the risk of lethal shock to human being and equipment safety. This paper briefly reviews various personnel protection devices also describes the basic working principle of conventional ground fault circuit interrupter (GFCI) or ground fault isolator (GFI), its disadvantages and ways to overcome the disadvantages with solid-state relay (SSR) based GFI with ultrafast response up on fault implemented in printed circuit board. This solid state GFI comprises discrete MOSFET based alternating current (AC) switches, linear optical amplifier, photovoltaic isolator and sense resistor. In conventional GFI, current transformer is employed as a sensing element to detect the difference in current flow between live and neutral conductor. If there is no fault in equipment powered through GFI, due to insulation failure of internal wires and windings of motors, both live and neutral currents will be equal in magnitude and opposite in phase.

Keywords—current transformer, electrocution, GFCI, GFI

I. INTRODUCTION

THERE are number of devices available for prevention of electric shock. These devices are known as personnel protection devices referred in [1]. These devices are listed as follows: appliance leakage circuit interrupter (ALCI), immersion detection circuit interrupter (IDCI), grounding detector (GDT) and GFI. Among those devices, GFI is widely used to prevent from electric hazards to prevent from electrocution. If a person accidentally touches a part of any portable electric tools such as drilling machine, vacuum cleaner, and electric iron with any electrical leakage through metallic part causing persistent leakage current to earth, GFI will prevent from electric shock by isolating the incoming AC supply to device. Even a few milliamperes of leakage current through human being will cause lethal shock. The perception of electric shock may be minor and some time it may leads to ventricular fibrillation. Based on the allowable leakage current and its threshold, Underwriters Laboratories (UL) specifies different classes of GFI [1]. It is important to note that GFI will not limit the magnitude of fault current irrespective of the nature of fault, whether it may be due to leakage to earth or it may be due to short circuit. Therefore, it is possible for a person to receive a shock on a circuit protected by a GFI. The magnitude of any fault current is limited by the supply voltage and the impedance in the fault circuit.

I Made Darmayuda, Zhou Jun, Krishna Mainali, Simon Ng Sheung Yan and Saisundar S are with Institute of Microelectronics, A*STAR, 11 Science Park Road, Singapore Science Park II, Singapore 117685 (e-mail: imaded@ime.a-star.edu.sg).

Eran Ofek is working as Chief Scientist with Ney-Li Pte Ltd, 20 Cecil street, #14-01, Equity Plaza, Singapore 049705 (e-mail: eofek@ney-li.com).

Unfortunately in majority of the cases, human being is the principal impedance source, and the magnitude of the shock can therefore vary considerably, depending on the condition of the skin, contact area, body weight, and current path through the body. In [1], it is indicated that 500Ω is the nominal impedance value for 120V system, the fault current flowing through human being may be around 500mA. But human being can only withstand the current range between 0.05-0.5mA without impairing the ability to let go. UL typically requires that leakage levels on tools and appliances must be less than 0.5mA (about one-tenth the level necessary to trip a GFI). Current through human body in the range of 2-5mA can produce involuntary muscular reaction causing to physical injury. A current level slightly higher than 6mA can create serious injury and consequently UL sets upper trip level for GFI as 6mA based on ability to let go from source or part of the faulty equipment which is leaking current through human body. This Paper reviews the existing personal protection devices in section II and particularly conventional GFI, merits and demerits. Section III describes solid-state equivalent of GFI by replacing the electromechanical relay (EMR) with MOSFETs and differential current transformer will be replaced by sense resistors.

II. PERSONNEL PROTECTION DEVICES

A. Immersion Detection Circuit Interrupter (IDCI)

Nowadays we are using many products having direct or indirect contact with water. If any product is accidentally dropped into water, then there will be multiple current paths through water and body. The magnitude of the current depends on the internal geometry of the device, conductivity of the water, and the proximity of the person to the live parts of the device and water. The immersion-detection circuit-interrupter is the device that interrupts the electric circuit to an appliance in the event of an accidental immersion of the appliance. The UL 1664 specifies standard for these kinds of immersion detection circuit interrupters to be effective for protection. Although the sensing mechanism of the IDCI might be different from that of a GFCI, it is still required to limit the shock current to time and magnitude levels based on the physiological effects of current through the body.

A simplified IDCI circuit diagram is shown in Figure 1. It consists of an EMR with double pole contact, relay coil and its relay driver with adequate driving strength need to drive relay. A sensing lead is connected to the relay driver through current limiting impedance that limits the current flow if the sense wire is directly shorted to the line conductor.

During accidental immersion, water conducts current between line conductors and sense lead and current flows into the relay driver to trigger the relay to open the contacts.

UL 1664 requires an IDCI to have the same current versus trip time calibration as a GFCI.

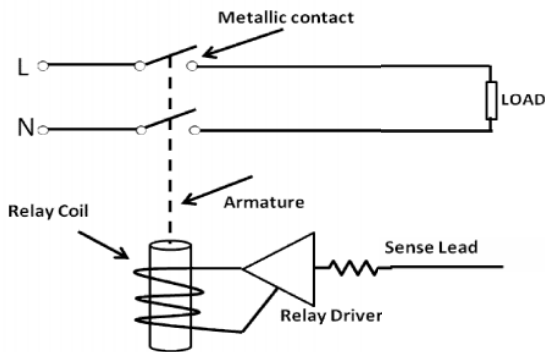

Fig. 1 Simplified Immersion Detection Circuit Interrupter

B. Appliance Leakage Circuit Interrupter (ALCI)

The key requirements of GFCI specified in standard UL standard 943 are open neutral protection and grounded neutral protection over a wide temperature range for appliance control. In some of the appliance applications, for example in two prong cord system, there may not be a need for all of these features and may be redundant.

For this reason, the ALCI has been developed as a simplified version of GFCI. The operating principles and time-versus-current calibration requirements of an ALCI are identical to those of a GFCI.

C. Grounding Detector

Another important personnel protection device is that Grounding detector (GDT) reported in [4]. The salient feature of GDT is that, it continuously monitors the voltage rise in housing in event of failure of electrical insulation inside the appliance and broken ground condition, the GDT immediately detects this hazardous condition and takes corrective action, by disconnecting the AC power from the hazardous appliance, and give indication.

In this case, housing of appliance becomes electrically hot, but GFI will take corrective action only, if a human comes in physical contact with or electrically hot appliance resulting in the flow of ground fault current. The GDT generates an independent reference ground potential with respect to the normally grounded conductor and AC line is not used to provide a reference potential.

This is because, which wire is live depends on the position of the AC plug in the receptacle in two prong power cord. The reference potential is generated by making use of isolated capacitance effect of conductive shapes. An aluminum or copper metal plate of dimension 1.0 times 1.45 inch is used for this purpose. Figure 2 shows the schematic diagram of the GDT comprising of live wire detector circuit and ground wire status detector circuit, timer, normally open power relay contact, double pole double throw polarity reversing relay, star network and neon lamp-cadmium sulfide (CdS) optoisolator assembly. The utility power is applied to GDT device and to equipment through normally open contacts of the contactor and directly to ground status detector circuit.

The ground wire is directly connected to the enclosure of the equipment, sensing lead is also connected from the equipment metal enclosure to one end of the resistor in the star network and double-pole double-throw polarity reversing relay alternatively connects each terminal to one electrode of the neon lamp of neon lamp-CdS optoisolator assembly, same time the other electrode of the neon lamp is connected to a reference ground plate. Relay coil is operated by live wire detection circuit up on its decision of live wire. Once the hot terminal is identified, the voltage at the star point is used to determine the voltage on the metal housing. The star-point resistors are specifically selected to allow the GDT to make a determination as to whether the metal housing is connected to earth ground, or is floating, or is connected to the hot terminal. This determination is made by measuring the voltage at the junction point of resistors forming the star or Y network.

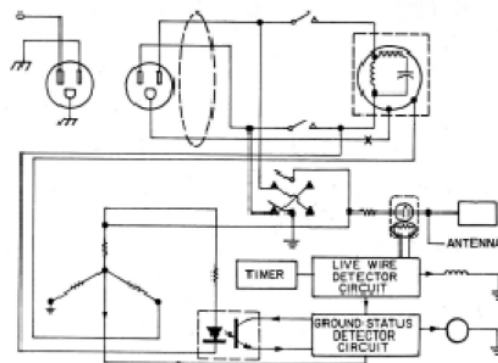

Fig. 2 Grounding Detector

D. Ground Fault Isolator (GFI)

A conventional GFI is shown in Figure 3, is equipped with a differential current transformer which senses the current flowing in both live and neutral conductor by using sense coil wound on a special type steel alloy [2], which encloses the line and neutral conductors. Clamp meters are also employing similar kind of current transformer except the fact that it encloses only one conductor which will acts as primary coil and secondary coil produce voltage proportional to the current. In GFI, ideally both currents should be equal, but in most of the practical cases there will be small differential current can be caused by grounded tools and appliances due to leakage current. Also, a differential current can result from other causes such as conductor and ground sharing the neutral with another ungrounded conductor or from capacitive leakage between the ungrounded circuits.

If a ground fault exists with some of the current flowing to ground and not returning on the neutral through the transformer, then the sum of the current flowing on the hot and neutral will not be zero. In this case differential transformer will induce a voltage proportional to the current leakage. UL specifies a standard for GFI (UL943) in order to afford the protection against electric shock. All GFI must comply with the formula given below.

$$T = \left[\frac{20}{I} \right]^{1.43} \quad (1)$$

Where T is trip time in seconds, and I is the fault current in milliamperes.

This formula is based on the physiological effects of human body model. Based on that fact for low level fault current GFI response time may be in the order of few seconds. But for relatively high fault current, the GFI should be able to trip with few tens of milliseconds. The GFI's electronic circuitry then measures its magnitude. If it reaches a predetermined level (the GFI trip threshold) for a given duration, a signal causes the trip coil to isolate the circuit. GFI receptacles are available for temporary power outlet as a part of the permanent wiring of the building; UL also specifies specific code of practice for installation, testing and maintenance of GFI. However, conventional GFIs are equipped with electromechanical relay (EMR) and this type relay has certain distinctive disadvantage because of its sluggish response, large volume, and contact bounce and chattering effects. Besides that, the amount of induced electromotive force in sense coil depends upon the distance between the current carrying conductor and center of sense coil. Finally, the conventional GFI cannot prevent non-ground induced electrocution which will happen, if a person is nicely elevated from the ground and he touches both line and neutral accidentally.

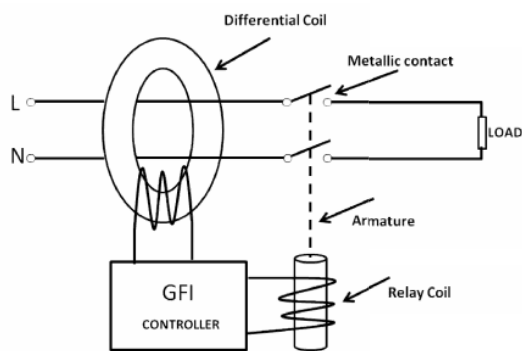

Fig. 3 Ground Fault Isolator

III. SOLID STATE MOSFET BASED GFI WITH SENSE RESISTOR

A basic GFI schematic comprising of sense resistors, pairs of MOSFETs configured as AC switch solid state relay (SSR) is shown in Figure 4. As opposed to conventional GFI, current differences in line and neutral conductors are detected by sense resistors by measuring the voltage drop across it. By doing this, the offset due to orientation and distance between line or neutral conductors running through differential transformer can be alleviated. A MOSFET based, high voltage, high current AC switching circuit selectively switches between switch conducting and switch isolation by appropriate decision from the controller. To simplify the power supply requirement and driver complexity, a photovoltaic isolator (PVI) is used as a MOSFET driver. In addition, the MOSFET switching assembly for use in a GFI will also perform as an impedance measurement system as part of a GFI application. Voltage drop across sense resistors along the line and neutral will be equal in magnitude and opposite in polarity as long as there is no leakage to ground from either conductor.

These voltage drops across the resistors are amplified by a couple of linear optical amplifier followed by op-amp based difference amplifier as shown in Fig 5.

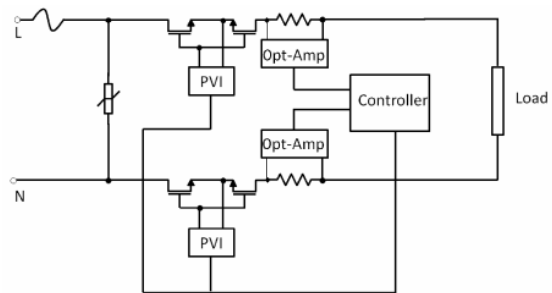

Fig. 4 GFI with Sense Resistors

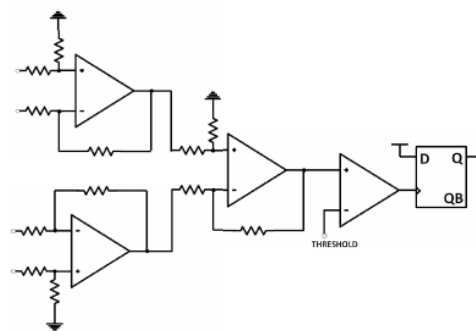

Fig. 5 Sense Resistors' Amplifier

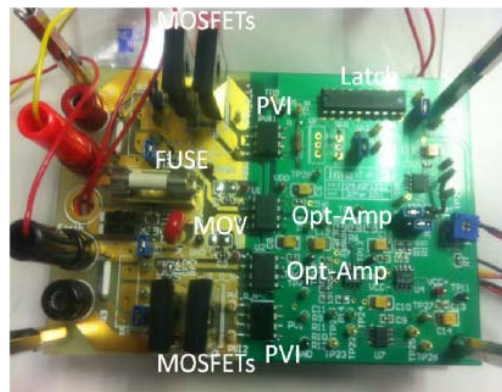

Fig. 6 Solid State MOSFET-Based GFI

A. Solid State Relay

A MOSFET based Solid State Relay (SSR) is implemented in PCB as shown Figure 6. It is semiconductor, non thyristor electronic equivalent of electromechanical (EMR) relay to switch electricity to a load. The SSR are reliable, small size, faster switching, robust, no chattering effect, no arcing and low input control power. MOSFETs are now available in packages that offer ever-increasing load currents, with lower on resistances, and at decreasingly lower price. Despite the fact of cost advantages, suitable gate driver for the MOSFET to be used in SSR is still complex. A photovoltaic isolator (PVI) is used as a gate driver and it has high degree of electrical isolation up to several hundred of volts between the control and load sides.

B. Photovoltaic Isolator

The Photovoltaic Isolator can be used as an optically isolated gate driver capable of directly driving gates of power MOSFETs or IGBTs. A simple MOSFET can be used as an AC switch with the suitable driver configuration, because MOSFET gate potential must be greater than source terminal by at least one threshold voltage.

It is important to note that PVI as gate driver should be able to withstand high common mode voltage (in the order of few hundred volts). This PVI utilizes a monolithic integrated circuit photovoltaic generator as its output. The output is controlled by radiation from a light emitting diode (LED) which is optically isolated from the photovoltaic generator.

The PVI is ideally suited for applications requiring high-current and or high voltage switching with optical isolation between the low level driving circuitry and high-energy or high voltage load circuits. It can be used for directly driving gates of power MOSFETs and are commercially available in DIP package.

IV. MEASUREMENT RESULTS

The experiment has been done with designed PCB shown in Figure 6 to verify the circuit functionality of GFI with light bulb load of 50 Watts and also with rheostatic load. The designed PCB has test and reset features by pressing the corresponding push button switch for performing the test easily. A set of BNC connectors were used applying AC input and to tap the output to load.

A fault was introduced by test button by connecting the resistive impedance between ground and one of the conductors. This will create a slight imbalance in the current flow between line and neutral conductors, which was detected by set of sense resistors and amplified by couple of cascaded differential amplifiers. Then the error difference was compared by a comparator against known threshold value. If the error value is higher than the threshold value, the comparator output reset the latch and consequently PVI output is disabled and thereby disconnecting the load. Response time of the GFI is about 340 μ Second after introducing the fault as shown in Figure 9.

V. CONCLUSION

The paper reviewed various personnel protection devices applicable for various electrical appliances for electrical hazard applications. It also discussed the pros and cons of conventional GFI and use of EMR in GFI.

This paper also demonstrated the implementation of ultrafast solid-state GFI with MOSFET based AC switch and feasibility of designing GFI with small form factor and still needs improvement for using it in high voltage applications, where leakage current will be significant. For three phase AC systems, phase to phase leakage current will be even higher than single phase AC systems.

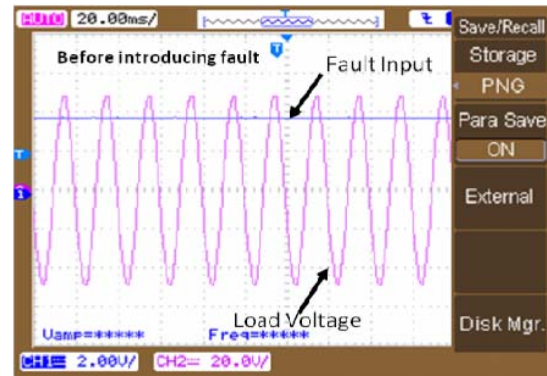

Fig. 7 Voltage before fault induction

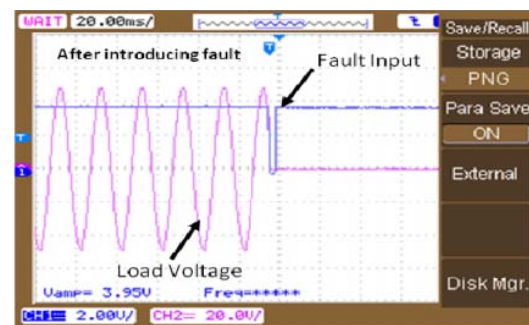

Fig. 8 Voltage after fault induction

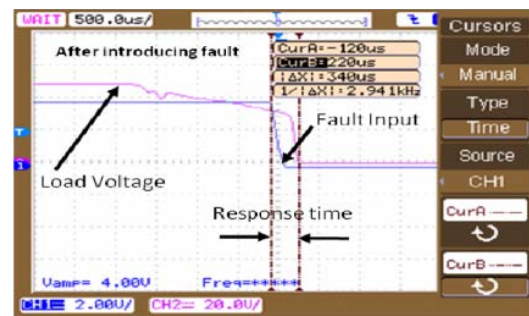

Fig. 9 GFI's response time

REFERENCES

- [1] Robert L. LaRocca, "Personnel Protection Devices for Use on Appliances," IEEE TRANSACTIONS ON INDUSTRY APPLICATIONS, VOL. 28, NO. 1, JANUARY/FEBRUARY 1992
- [2] Guenter B. Finke, Bao-Min Ma, A NEW TYPE OF DIFFERENTIAL TRANSFORMER CORE FOR GROUND FAULT CIRCUIT INTERRUPTERS, IEEE TRANSACTIONS ON MAGNETICS, VOL. MAG-17, NO. 6, NOVEMBER 1981.
- [3] Jaebok Lee, Sughun Chang, Sungho Myung, Yuengue Cho I. S. Jacobs and C. P. Bean, "Transient False Tripping Characteristic Analysis of Ground Fault Circuit Interrupter" International Conference on Power System Technology, November 2004.
- [4] Nosh K. Medora, S.M. P.E, Alexander Kusko, Sc.D., P.E. "Fault Sensing with an Artificial Reference Potential Provided by an Isolated Capacitance Effect, IEEE Symposium on product safety engineering society, October- 2006.
- [5] Arnold W. Smoot, , IEEE Senior Member, "GFCI-Applications and Alternatives", IEEE TRANSACTIONS ON INDUSTRY APPLICATIONS, VOL. IA-1 I, NO. 1, January/Februaryj 1975.
- [6] Jonathan Kimball, Senior Member, IEEE, Compatibility Between GFCI Breakers and Household Adjustable Speed Drives.