

# Evaluation of Efficient CSI Based Channel Feedback Techniques for Adaptive MIMO-OFDM Systems

Muhammad Rehan Khalid, Muhammad Haroon Siddiqui and Danish Ilyas

*Abstract*—This paper explores the implementation of adaptive coding and modulation schemes for Multiple-Input Multiple-Output Orthogonal Frequency Division Multiplexing (MIMO-OFDM) feedback systems. Adaptive coding and modulation enables robust and spectrally-efficient transmission over time-varying channels. The basic premise is to estimate the channel at the receiver and feed this estimate back to the transmitter, so that the transmission scheme can be adapted relative to the channel characteristics. Two types of codebook based channel feedback techniques are used in this work. The long-term and short-term CSI at the transmitter is used for efficient channel utilization. OFDM is a powerful technique employed in communication systems suffering from frequency selectivity. Combined with multiple antennas at the transmitter and receiver, OFDM proves to be robust against delay spread. Moreover, it leads to significant data rates with improved bit error performance over links having only a single antenna at both the transmitter and receiver. The coded modulation increases the effective transmit power relative to uncoded variable-rate variable-power MQAM performance for MIMO-OFDM feedback system. Hence proposed arrangement becomes an attractive approach to achieve enhanced spectral efficiency and improved error rate performance for next generation high speed wireless communication systems.

*Keywords*—Adaptive Coded Modulation, MQAM, MIMO, OFDM, Codebooks, Feedback.

## I. INTRODUCTION

**T**HE use of multiple antennas at the transmitter and receiver is by now a well recognized technique to achieve high data rates in wireless communications [1]-[4]. The radio spectrum is scarce and expensive resource, hence efficient channel utilization techniques are required to support high data rates. The multipath characteristics of the environment cause the MIMO channels to be frequency selective. For frequency selective deep fading, MIMO system remains ineffective. OFDM, a multicarrier transmission scheme, is well recognized for its potential to attain high rate transmission over frequency selective channels [5]. It can transform such a frequency-selective MIMO channel into a set of parallel frequency-flat channels. Implementing space resources based on OFDM i.e., MIMO-OFDM can provide higher data rates [6]. Thus the combination of the two powerful techniques, MIMO and

OFDM, is very attractive and promising broadband wireless communications scheme [7].

Adaptive modulation and coding enables robust and spectrally-efficient transmission over time-varying channels [8]-[17]. The basic premise is to estimate the channel at the receiver and feed this estimate back to the transmitter, so that the transmission scheme can be adapted relative to the channel characteristics. Modulation and coding techniques that do not adapt to fading conditions require a fixed link margin to maintain acceptable performance when the channel quality is poor. Thus, these systems are effectively designed for the worst-case channel conditions. Since Rayleigh fading can cause a signal power loss of up to 30 dB, designing for the worst case channel conditions can result in very inefficient utilization of the channel. Adapting to the channel fading can increase average throughput, reduce required transmit power, or reduce average probability of bit error by taking advantage of favorable channel conditions to send at higher data rates or lower power, and reducing the data rate or increasing power as the channel degrades.

Wireless channels are constantly changing due to multipath, movement of the receiver, and also the changes in environment. Having knowledge of the channel prior to the transmission is very valuable. It enables the transmitter to exploit the channel in the best possible way. CSI is fed back to the transmitter as CSIT [18]. A multitude of different transmission techniques have been proposed in literature, especially for the special cases of full CSIT and no CSIT. The throughput can be significantly improved if CSIT is available. CSIT helps in adapting the transmitted signal to the time varying channel. Obtaining CSIT for MIMO systems require considerably higher amount of bandwidth than SISO systems to transmit CSI back to the transmitter, as there are multiple antennas and a large amount of CSI has to be sent back to the transmitter. Since CSI is estimated at the receiver so it has to be communicated to the transmitter using as few bits as possible, thus utilizing the minimum possible bandwidth. Hence low rate channel feedback schemes are required [19]-[24]. Also, the channel is continuously varying and CSIT becomes continuously outdated, therefore a continuous feedback is required from the receiver to maintain a specific performance level.

## II. RELATED WORK

In order to send the CSI back to the transmitter in MIMO systems, several techniques have proposed. Low rate channel

Muhammad Rehan Khalid is with Electrical Engineering Department, National University of Sciences and Technology (NUST), Pakistan (e-mail: mrehan@mcs.edu.pk).

Muhammad Haroon Siddiqui is with Electrical Engineering Department, National University of Sciences and Technology (NUST), Pakistan (e-mail: haroon@mcs.edu.pk).

Danish Ilyas is with Electrical Engineering Department, National University of Sciences and Technology (NUST), Pakistan (e-mail: dilyaspk@gmail.com).

feedback techniques [19]-[24] include Channel Norm feedback techniques [25] and Codebook based channel feedback techniques. The scope of this paper is to discuss codebook based feedback techniques. The codebook based techniques, proposed by Tung [26], combine long-term and low-rate short-term CSI over correlated MIMO channels which increase the expected rate as compared to techniques using only short-term CSI or only long-term CSI. The long-term CSI is collected in the form of an estimated covariance matrix of the Rayleigh fading channel statistics and the eigenvectors of the resulting covariance matrix are used as the unitary matrix. The work presented here is based on the work of [26]-[29], and is extended to MIMO-OFDM feedback systems combined with adaptive modulation and coding.

The paper is organized as follows. In section III, the overall system model of coded adaptive MIMO-OFDM feedback system is presented with comprehensive description. In this section, we also highlight codebook based channel feedback techniques including decorrelating linear transformation and feedback index selection. SVD technique for MIMO-OFDM subcarriers is also demonstrated in this section. Section IV presents meticulous discussion of adaptive transmission techniques including adaptive coding and MQAM adaptive modulation. Section V presents comprehensive simulation results and comparisons to highlight the overall performance gain. Finally concluding remarks are presented in Section VI.

### III. SYSTEM MODEL

Fig. 1 represents the overall system block diagram of a generalized MIMO-OFDM system with  $N_t$  transmit and  $N_r$  receive antennas. The modulator maps the input to a complex constellation symbol relative to the number of bits on the input of the modulator. In this adaptive modulation system, the modulator is designed as a function of measured channel characteristics. For a subchannel with high SNR, modulation order such as 64-QAM is used to increase the data rate. Similarly, a lower modulation order such as QPSK is performed on a poor subchannel to reduce the error rate. The OFDM symbols transmitted vector is represented by  $s$ , and the components of white noise  $n$  are complex Gaussian with zero mean and unit variance.

Fig. 2 shows the block diagram of the codebook based channel feedback model.  $H \in C^{N_r \times N_t}$  represents the complex channel matrix, where  $N_t$  and  $N_r$  represent the number of transmit and receive antennas respectively.  $W_i$  represents the precoding matrix which comes from the codebook  $W_i$ .  $U$  represents a unitary matrix and  $I \in \{0, \dots, 2^K - 1\}$  is the index of the precoding matrix, where  $K$  is the number of feedback bits. The system model can be written in the form

$$y = HUW_i s + n \quad (1)$$

#### A. SVD of MIMO Subcarriers

Channel matrix singular value decomposition (SVD) method is employed in MIMO-OFDM systems in order to overcome subchannel interference. It allows to allocate the

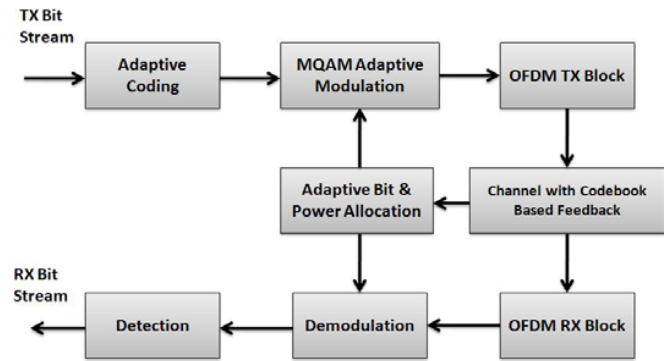

Fig. 1. Overall Block Diagram for Coded Adaptive MIMO-OFDM Feedback System

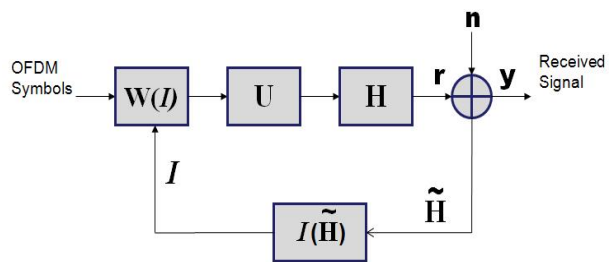

Fig. 2. Block Diagram of Feedback Model

transmitted bit and power through the subchannels in an optimum manner. The SVD technique can be directly applied to the MIMO channel decomposition when perfect CSI knowledge is available at the transmitter side. The MIMO channel can be decomposed into a set of parallel SISO channels by applying a unitary pre-filtering and post-filtering matrix to the transmitted and received signal respectively [30], as shown in Fig. 3. In the notation of matrices, the matrix  $H$  has the singular value decomposition:

$$H_i = U_i S_i V_i^* \quad (2)$$

Now, if we use a transmit precoding filter  $V_i$  and a receiver shaping filter  $U_i$ , the equivalent MIMO channel between the IFFT and FFT blocks decomposes into parallel subchannels. Therefore, we can use each parallel subchannel's SNR to specify the number of bits and energy allocated. In general, each precoder and shaping matrix will be different for different subchannels. The optimization problem will be larger for MIMO channels than in SISO case, but the decomposition has allowed us to proceed without any changes to the optimization algorithm [30].

#### B. Codebook based Feedback Techniques

Codebook based techniques represent a class of CSI feedback schemes in which transmitter and receiver has the same

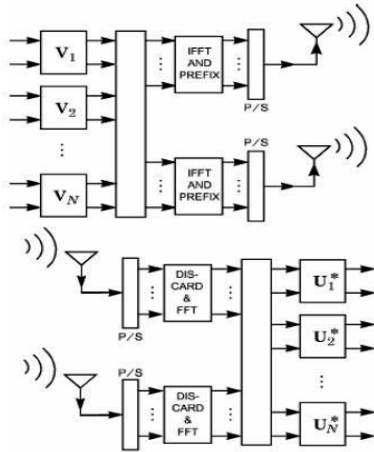

Fig. 3. SVD in MIMO-OFDM

set of codebooks available. The two feedback techniques considered in this paper are described in [26]. The codebooks contain precoding matrices  $W_i$  and transmit covariance matrices  $Q_i$ , where  $i$  is the feedback index. The size of the codebook depends on the number of feedback bits. The codebooks are optimized using convex optimization techniques. The training algorithm for generation of codebooks is demonstrated in [26].

1) *Decorrelating Linear Transformation (DLT)*: The first technique uses the long-term channel statistics to perform a unitary transformation of the channel coefficients. DLT is based on estimating the unitary matrix from the long-term channel statistics. This linear transformation will decorrelate the channel coefficients which results in a more efficient codebook. The main point of DLT is that the transformed CSI can be transmitted back to the transmitter with low overhead. It decouples the channel and increases the capacity of the channel. The Covariance matrix  $R^{Tx}$ , estimated from long-term channel statistics, is given by

$$R^{Tx} = \frac{1}{N} \sum_{n \in N} H^H(n)H(n) \quad (3)$$

where  $H$  is the MIMO channel matrix. Singular value decomposition of  $R^{Tx}$  gives  $U^{Tx}$  and  $D$  according to the following relation.

$$U^{Tx}D^{Tx}(U^{Tx})^H = R^{Tx} \quad (4)$$

where  $U^{Tx}$  is the decorrelating matrix calculated using the available channel statistics.

The second feedback technique uses only the low-rate short-term CSI. It is dependent on the feedback obtained from the receiver. Unlike the first technique, it only depends on the instantaneous CSI. It does not rely on the long-term statistics of the channel like the first technique. Here we do not need to estimate the decorrelating unitary matrix. Hence this technique is not computationally as rigorous as the first one. Though

this technique bears shortcomings interms of throughput as compared to the first one.

2) *Index Selection*: Two different methods can be used for the selection of the feedback index described in [26]-[29]. First one is the mutual information based index selection, and second one is based on channel norm. Mutual information based index selection is a useful method when using adaptive modulation and coding. While channel norm based index selection is useful when fixed modulation and coding is used.

In Mutual Index Selection (MIS), the index is selected based on the Shannon Capacity equation. This scheme was used in [26]-[29], and the codebooks have been designed for this scheme. In this method, the Index corresponding to precoding matrix  $W_i$  which gives the highest expected rate is denoted by  $I$ . The following relation shows the feedback index selection in MIS

$$I = \arg \max_i \det(I_{N_r} + HUQ_iU^H H^H) \quad (5)$$

where

$$Q_i = W_iW_i^H \quad (6)$$

Channel Capacity is calculated for all the transmit covariance matrices  $Q_i$  in a particular codebook. The index of the matrix which gives the best performance for that sample instant is sent back to the transmitter. The respective transmit covariance matrix  $Q_i$  is used in the next transmission.

#### IV. ADAPTIVE CODING AND MODULATION

##### A. Adaptive Modulation

The advantage of OFDM is that each subchannel is relatively narrowband and is assumed to have flat-fading. However, it is entirely possible that a given subchannel has a low gain, resulting in a large BER. The variation in fading statistics among different subcarriers in OFDM channels suggest that some good subcarriers with high channel power gain can be made to carry more bits and be allocated with less transmission power, and vice versa for relatively weaker subcarriers [32]. Thus, it is desirable to take advantage of the subchannels having relatively good performance.

The optimal adaptive transmission scheme, which achieves the Shannon capacity for a fixed transmit power is the waterfilling distribution of power over the frequency selective channel [30]. However, while the waterfilling algorithm will indeed yield the optimal solution, it is difficult to implement practically.

Two adaptive loading algorithms are implemented in this work for adaptive rate and power allocation [32] to each subchannel. Initially each subchannel is allocated energy and bits using Chow's allocation [33]. Then optimized energy and bit allocation is done using Campello's algorithm [34, 35].

##### B. Adaptive Coded Modulation

Additional coding gain can be achieved with adaptive modulation by superimposing trellis codes or more general coset codes on top of the adaptive modulation. Specifically, by using the subset partitioning inherent to coded modulation,

trellis or lattice codes designed for AWGN channels can be superimposed directly onto the adaptive modulation with the same approximate coding gain. The basic idea of adaptive coded modulation is to exploit the separability of code and constellation design inherent to coset codes.

Coded modulation is a natural coding scheme to use with variable-rate variable-power MQAM, since the channel coding gain is essentially independent of the modulation. We can therefore adjust the power and rate (number of levels or signal points) in the transmit constellation relative to the instantaneous SNR without affecting the channel coding gain.

The coded modulation scheme is shown in Fig. 4. The coset code design is the same as it would be for an AWGN channel, i.e., the lattice structure and conventional encoder follow the trellis or lattice coding designs. Let  $G_c$  denote the coding gain of the coset code given by

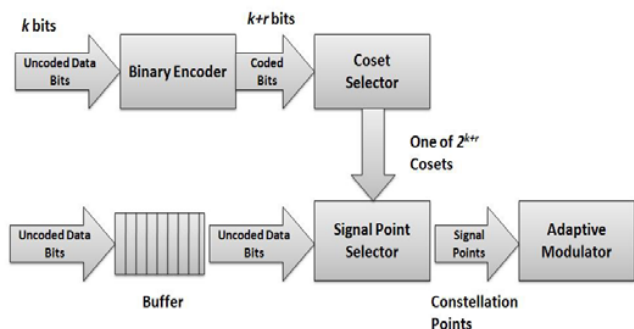

Fig. 4. Adaptive Coded Modulation Scheme

$$G_c = 2^{-\frac{2r}{N}} d_{min}^2 \quad (7)$$

where  $2^{-\frac{2r}{N}}$  is the constellation expansion factor in (in two dimensions) from the  $r$  extra bits introduced by binary channel encoder, and  $d_{min}$  denotes the minimum distance code given by

$$d_{min} = (d_p, d_s) \quad (8)$$

where  $d_p$  denotes the minimum distance between points within a coset, and  $d_s$  denotes the minimum distance between the coset sequences.

The source coding (modulation) works as follows. The signal constellation is a square lattice with an adjustable number of constellation points  $M$ . The size of the MQAM signal constellation from which the signal point is selected is determined by the transmit power, which is adjusted relative to the instantaneous SNR and the desired BER, as in the uncoded case above.

The bit error rate (BER) for an AWGN channel with MQAM modulation, ideal coherent phase detection, and SNR  $\gamma$  [30] is bounded by

$$P_b \leq 2e^{-1.5\gamma/(M-1)} \quad (9)$$

A tighter bound good to within 1 dB for  $M \geq 4$  and  $0 \leq \gamma \leq 30dB$  is

$$P_b \leq 0.2e^{-1.5\gamma/(M-1)} \quad (10)$$

## V. RESULTS

### A. Assumptions and Simulation Parameters

For the scope of this work, six different signal constellations are used,  $M \in \{0,1,2,4,6,8\}$ . We assume that the feedback channel is perfect. Although a noisy or imperfect channel could be assumed, see for example [26]. Here we mainly focus on perfect feedback with  $K \in \{1,2,4\}$ , where  $K$  is the number of feedback bits. The parameters used for OFDM throughout the simulations are: 64 subcarriers, OFDM symbol time of 64 symbol periods and Guard interval of 16 symbol periods.

### B. Results and Analysis

Fig. 5 shows the expected rate performance for the MIMO system with codebook based channel feedback over a series of SNRs. The results are simulated for the cases of perfect CSIT and 4-bit feedback both with the first feedback technique, in which the Unitary matrix is estimated from long-term channel statistics. Fig. 6 shows the expected rate performance for the same system for all the cases highlighted in Fig. 5 with second feedback technique, based only on instantaneous channel information.

Fig. 7 indicates the performance gain obtained with the implementation of OFDM in the fixed modulated MIMO feedback system. A performance gain of about 3 dB is observed with the incorporation of OFDM [29]. Fig. 8 highlights the performance gain acquired with the implementation of adaptive modulation and coding in the MIMO-OFDM feedback system. Adaptive bit and power allocation schemes further enhance the performance gain to an appreciable extent of 4.5 dB. Coded adaptive MIMO-OFDM feedback system provides a substantial coding gain of about 1 dB, as illustrated in Fig. 8. Hence, a net appreciable performance gain of about 5.5 dB is obtained with the incorporation of OFDM, adaptive modulation and coded adaptive modulation in the MIMO system with codebook based channel feedback.

Fig. 9 shows the error rate performance of the coded and uncoded adaptive MIMO-OFDM feedback systems. It is clearly evident that coded system provides lower error rate than the uncoded one. The comparisons are evaluated for different values of SNR, in terms of number of errors. Hence proposed arrangement becomes an attractive approach to achieve enhanced spectral efficiency and improved error rate performance for next generation high speed wireless communication systems.

## VI. CONCLUSION

This paper explores the implementation of adaptive coding and modulation schemes for MIMO-OFDM feedback systems. Adaptive coding and modulation enables robust and spectrally-efficient transmission over time-varying channels. MIMO-OFDM system combines the advantages of both the techniques

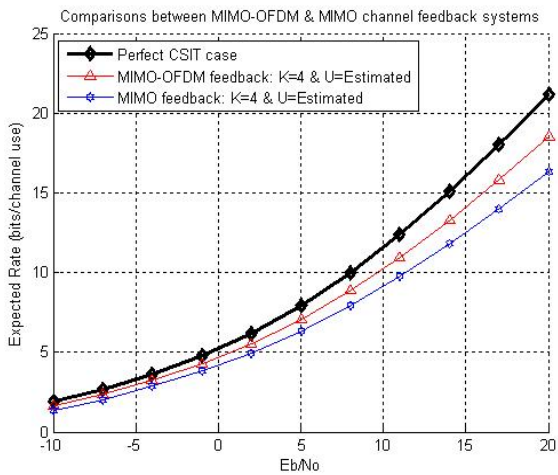

Fig. 5. Performance Results for MIMO-OFDM Feedback System: k = 4, First Feedback Technique

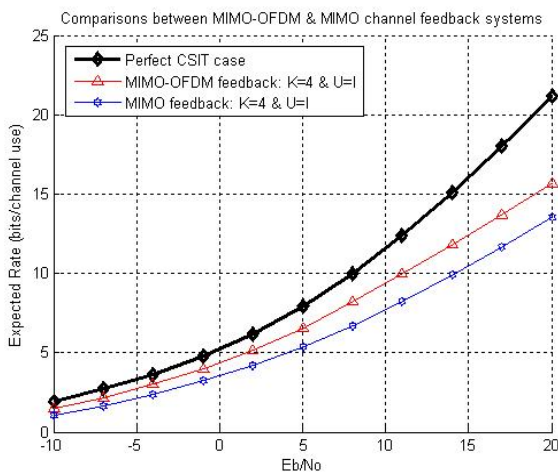

Fig. 6. Performance Results for MIMO-OFDM Feedback System: k = 4, Second Feedback Technique

Illustration of Performance Gain in dB

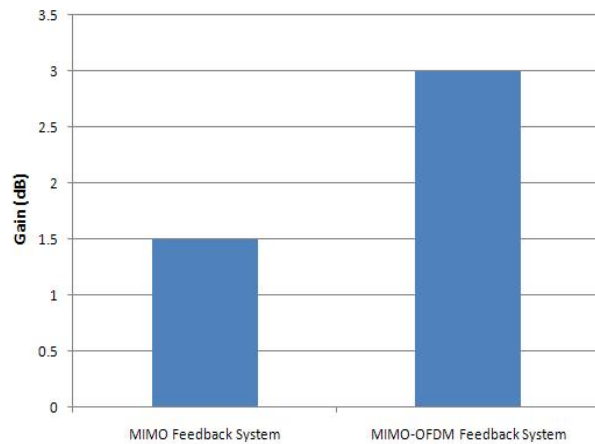

Fig. 7. Illustration of Performance Gain

Illustration of Coding Gain in dB

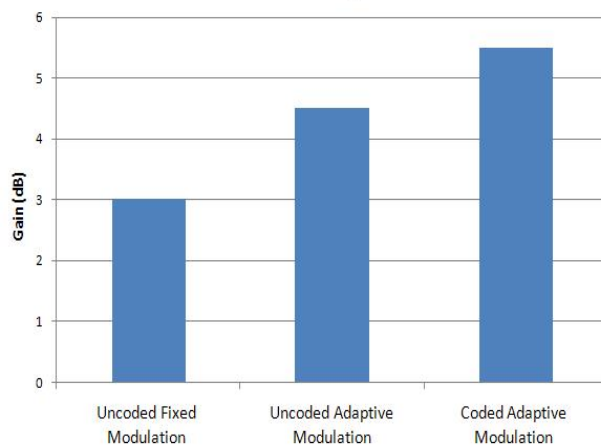

Fig. 8. Illustration of Coding Gain for Adaptive Coded Modulation Scheme

i.e., MIMO and OFDM to simultaneously increase spectral efficiency, and eliminate the effects of delay spread in a multipath fading environment. Comprehensive analysis and comparisons of simulation results show that coded adaptive modulation for MIMO-OFDM feedback system provides considerable improvement as compared to the uncoded one. The coded modulation increases the effective transmit power relative to uncoded variable-rate variable-power MQAM performance for MIMO-OFDM feedback system. Hence proposed arrangement becomes an attractive approach for next generation high speed wireless communication systems.

ACKNOWLEDGMENT

The authors thank Ahmed Farhan Hanif (Telecom Sud-Paris, France) for his influential support and cooperation to

accomplish this extremely exigent task. The authors express their sincerest gratitude to him for his constant assistance and guidance.

REFERENCES

- [1] A. Paulraj, R. Nabar, D. Gore, *Introduction to space-time wireless communications*, May 2003, ISBN: 0521826152.
- [2] Siavash M. Alamouti, "A simple transmit diversity technique for wireless communications," *IEEE Transactions on Comm.*, vol. 43, no. 2, pp. 773-775, Feb. 1995.
- [3] A. J. Paulraj, D. A. Gore, R. U. Nabar, H. Bolcskei, "An overview of MIMO communications - a key to gigabit wireless," *Proceedings of the IEEE*, vol. 92, no. 2 pp. 198-218, Feb. 2004.
- [4] A. Naguib, N. Seshadri, "Increasing data rates over wireless channels," *IEEE Signal Processing Magazine*, vol. 9, pp. 76-92, May 2000.
- [5] A. Bahai, B. Saltzberg, *Multicarrier Digital Communications: Theory and Applications of OFDM*, Kluwer Academic, New York, 1999.

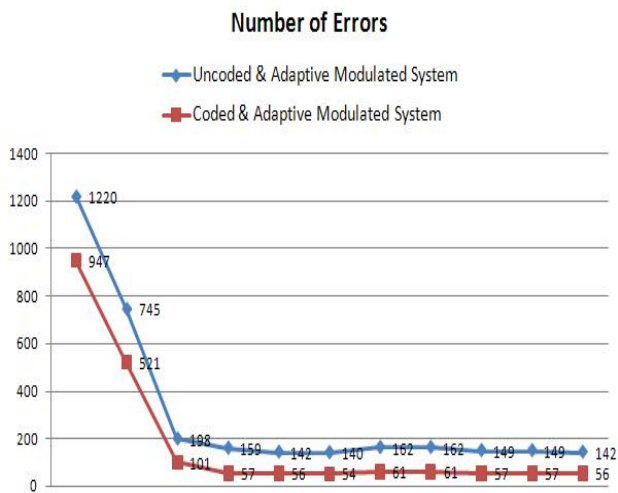

Fig. 9. Comparison of Error Rate Performance

- [6] P. Uthansaku, M. E. Bialkows, "Multipath signal effect on the capacity of MIMO, MIMO-OFDM and spread MIMO-OFDM," *15th International Conference on Microwaves, Radar and Wireless Communications*, vol. 3, pp. 989-992, 17-19 May 2004.
- [7] G. L. Stuber, J. R. Barry, S. W. McLaughlin, Y. G. Li, M. A. Ingram, T. G. Pratt, "Broadband MIMO-OFDM Wireless Communications," *Proceedings of IEEE*, vol. 92, pp. 271-294, Feb. 2004.
- [8] J. F. Hayes, "Adaptive feedback communications," *IEEE Trans. Commun. Technol.*, pp. 24-34, Feb. 1968.
- [9] J. K. Cavers, "Variable-rate transmission for Rayleigh fading channels," *IEEE Trans. Commun.*, pp. 15-22, Feb 1972.
- [10] S. Otsuki, S. Sampei, and N. Morinaga, "Square-QAM adaptive modulation/TDMA/TDD systems using modulation level estimation with Walsh function," *Electr. Lett.*, pp. 169-171, Feb. 1995.
- [11] W. T. Webb and R. Steele, "Variable rate QAM for mobile radio," *IEEE Trans. Commun.*, pp. 2223-2230, July 1995.
- [12] Y. Kamio, S. Sampei, H. Sasaoka, and N. Morinaga, "Performance of modulation-level-controlled adaptive modulation under limited transmission delay time for land mobile communications," in *Proc. IEEE Vehic. Technol. Conf.*, pp. 2212-25, July 1995.
- [13] S. T. Chung and A. J. Goldsmith, "Degrees of freedom in adaptive modulation: a unified view," *IEEE Trans. Commun.*, vol. 49, pp. 1561-1571, Sept. 2001.
- [14] S. Nanda, K. Balachandran, and S. Kumar, "Adaptation techniques in wireless packet data services," *IEEE Commun. Mag.*, pp. 54-64, Jan. 2000.
- [15] K.M. Kamath and D.L. Goeckel, "Adaptive-modulation schemes for minimum outage probability in wireless systems," *IEEE Trans. Commun.*, vol. 52, pp. 1632-1635, Oct. 2004.
- [16] M. S. Alouini and A. J. Goldsmith, "Adaptive modulation over Nakagami fading channels," *Kluwer Journal on Wireless Personal Communications*, pp. 119-143, May 2000.
- [17] S. Vishwanath, S. A. Jafar, and A.J. Goldsmith, "Adaptive resource allocation in composite fading environments," *Proc. IEEE Global Telecommun. Conf. (GLOBECOM)*, pp. 1312-1316, Nov. 2001.
- [18] J. H. Sung and J. R. Barry, "Space-time processing with channel knowledge at the transmitter," *European Conference on Communications*, Bratislava, vol. 1, pp. 26-29, July 5-7 2001.
- [19] V. Lau, Y. Liu, and T. A. Chen, "On the design of MIMO block fading channels with feedback link capacity constraint," *IEEE Transactions on Communications*, vol. 52, pp. 62-70, Jan. 2004.
- [20] K. K. Mukkavilli, A. Sabharwal, E. Erkip, and B. Aazhang, "On beamforming with finite rate feedback in multiple antenna systems," *IEEE Transactions on Information Theory*, vol. 49, pp. 2562-2579, Oct. 2003.
- [21] D. J. Love and R. W. Heath, Jr., "Limited feedback diversity techniques for correlated channels," *IEEE Transactions on Veh. Technologies*, vol. 55, pp. 718-722, Mar. 2006.
- [22] D. J. Love, R. W. Heath, Jr., and T. Strohmer, "Grassmannian beamforming for multiple-input multiple-output wireless systems," *IEEE Transactions on Information Theory*, vol. 49, pp. 2735-2747, Oct. 2003.
- [23] A. Narula, M. J. Lopez, M. D. Trott, and G. W. Wornell, "Efficient use of side information in multiple antenna data transmission over fading channels," *IEEE Journal on Selected Areas in Communications*, vol. 16, pp. 1423-1436, Oct. 1998.
- [24] A. D. Dabagh and D. J. Love, "Feedback rate-capacity loss tradeoff for limited feedback MIMO systems," *IEEE Transactions on Information Theory*, vol. 52, pp. 2190-2202, May 2006.
- [25] Emil Bjornson, David Hammarwall, Bjorn Ottersten, "Exploiting quantized channel norm feedback through conditional statistics in arbitrarily correlated MIMO systems," *IEEE Transactions on Signal Processing*, To appear.
- [26] Kim, T.T.; Bengtsson, M.; Larsson, E.G.; Skoglund, M., "Combining long-term and low-rate short-term channel state information over correlated MIMO channels," *IEEE Transactions on Wireless Communications*, vol. 7, no. 7, pp. 2409-2414, Jul. 2008.
- [27] A. F. Hanif, M. Bengtsson, "Evaluation of low rate channel feedback schemes for MIMO systems," *Proceedings of Future Network and Mobile Summit*, June 2010.
- [28] A. F. Hanif. Evaluation of low rate channel feedback schemes for MIMO systems. Master's Thesis, Royal Institute of Technology, Oct. 2009.
- [29] M. R. Khalid, A. F. Hanif and A. A. Khan, "Analysis of codebook based channel feedback techniques for MIMO-OFDM systems," *VII 2011 International Conference on Wireless Communications and Mobile Computing ICWCMC'11*, Bangkok, Thailand, pp. 297-301, Dec. 2011.
- [30] A. Goldsmith, *Wireless Communications*, Cambridge University Press, 2005.
- [31] A. Bahai, B. Saltzberg, *Multicarrier Digital Communications: Theory and Applications of OFDM*, Kluwer Academic, New York, 1999.
- [32] C. Wong et al, "Multiuser subcarrier allocation for OFDM transmission using adaptive modulation," *VTC99*, vol. 43, no. 2, pp. 479-483, 1999.
- [33] P. Chow et al, "A Practical Discrete Multitone Transceiver Loading Algorithm for Data Transmission over Spectrally Shaped Channels," *IEEE Transactions on Comm.*, vol. 43, no. 2, pp. 773-775, Feb. 1995.
- [34] J. Campello, "Optimal discrete bit loading for multicarrier modulation systems," *Proc. of the IEEE Int. Symp. on Information Theory*, p. 163, Cambridge, MA, USA, Aug. 1998.
- [35] J. Campello et al, "Practical bit loading techniques for Discrete Multi Tone (DMT)," *IEEE International Conference on Communications ICC99*, pp. 801-805, 1999.