

# Optimal Switching Strategies for Tracking of Currents of Voltage Source Converters

R. Oloomi, and M. A. Sadrnia

**Abstract**—This paper proposes a new optimal feedback controller for voltage source converters VSC's, for current regulated voltage source converters, which allows compensate the harmonics of current produced by nonlinear loads and load reactive power. The aim of the present paper is to describe a novel switching signal generation technique called optimal controller which guarantees that the injected currents follow the reference currents determined by the compensation strategy, with the smallest possible tracking error and fixed switching frequency. It is compared with well-known hysteresis current controller HCC. The validity of presented method and its comparison with HCC is studied through simulation results.

**Keywords**—Hysteresis Current Controller, Optimal Controller, Switching pattern, Voltage Source Converter.

## I. INTRODUCTION

INCREASING of imbalance and nonlinear loads in distribution systems has resulted in excessive harmonic injection and reactive power burden in the utility.

Active power filters have been developed to reduce the harmonics [1-3]. The current control system is the key problem to realize compensation objectives of active power filters. Different control strategies have been presented to control these systems but they differ in dynamic response and the switching frequency [4-5]. HCC is a popular current controller in active filter. In this controller three units are used independently, one for each phase. The output from this HCC drives directly the switches of VSC. It is obvious that there is no relation between switching function of the three phases. This lack of coordination between three individual units results in high number of switching. By using HCC, it is not possible to control the switching frequency.

In practice, the conventional 2-level or 3-level three phases bridge structure is adopted to build up the voltage source converter VSC. For the distribution networks, the power switch device such as IGBT has more superiority over GTO because IGBT can switch at high frequency and control easily. In this paper, an optimal controller, which the decision about its switching on/off is in fixed time intervals, is proposed.

The aim of the present paper is to describe a novel switching signal generation technique called optimal controller which guarantees that actual currents track its reference compensating currents as close as possible. The aim

is to prove that the proposed technique performs better at minimizing the square tracking error between the reference and real currents than the other controllers.

Features of this controller are simplicity, quick response, insensitivity and stability to distortion and lower number of switching. In addition it has fixed decision time intervals i.e, fixed switching frequency. A comparison is made with HCC applied to the same system.

## II. MATHEMATICAL OF MODEL TWO-LEVEL CONVERTER

Fig. 1 shows the main circuit topology of VSC in connection with three-phases utility and loads.

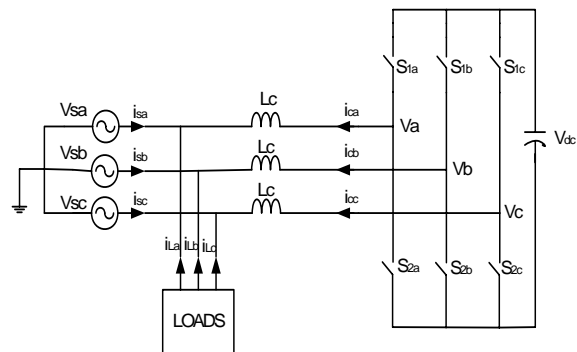

Fig. 1 Power circuit topology of VSC

From reference [6] the equations of converter are:

$$\begin{aligned} V_a &= L_c \frac{di_{ca}}{dt} + V_{sa} \\ V_b &= L_c \frac{di_{cb}}{dt} + V_{sb} \\ V_c &= L_c \frac{di_{cc}}{dt} + V_{sc} \end{aligned} \quad (1)$$

$$\begin{aligned} V_a &= (S_a - \frac{S_a + S_b + S_c}{3})V_{dc} \\ V_b &= (S_b - \frac{S_a + S_b + S_c}{3})V_{dc} \\ V_c &= (S_c - \frac{S_a + S_b + S_c}{3})V_{dc} \end{aligned} \quad (2)$$

where  $i_{ca}$ ,  $i_{cb}$  and  $i_{cc}$  are actual compensating currents,  $V_a$ ,  $V_b$  and  $V_c$  are terminal voltages of VSC,  $V_{sa}$ ,  $V_{sb}$  and  $V_{sc}$  which

Authors are with the Electrical Engineering Department, Shahrood University of Technology, Shahrood, Iran (phone: 0098 273 3368418; fax: 0098 273 3333116; e-mail: masadrnia@yahoo.com).

are common coupling point voltages. In eq.2 Sa, Sb and Sc are switching functions and are defined as follows:

$$S_i = \begin{cases} 1 & \text{if } S_{1i} \text{ is conducting} \\ 0 & \text{if } S_{2i} \text{ is conducting} \end{cases} \quad i = a, b, c$$

The state variables are chosen as follows:

$$\underline{x} = [i_{ca}(t) \quad i_{cb}(t) \quad i_{cc}(t)]^T \quad (3)$$

By defining the Sa, Sb and Sc as input controlling signals of control circuit, the optimal controller must generate such switching signals that actual currents of VSC track its reference compensating currents as close as possible.

### III. CONTROL STRATEGY

#### A. Hysteresis Current Controller

Each VSC has three legs, one in each phase. Each phase of VSC consist of two switches (an IGBT with an anti parallel diode). Mid point of a leg is called as converter pole point.

The HCC switching laws are described as follows:

- 1)  $i_{act} > i_{ref} + hb$ , upper of a leg is OFF and lower switch is ON.
- 2)  $i_{act} < i_{ref} - hb$ , upper of a leg is ON and lower switch is OFF.

where hb is hysteresis band around the reference currents,  $i_{ref}$  and  $i_{act}$  is actual current. The narrower hysteresis band results in higher switching frequency and vice versa. So by using HCC, the number of switching is high that result in switching losses. Also it is not possible to control the switching frequency. Fig. 2 shows principle of tracking problem by this controller.

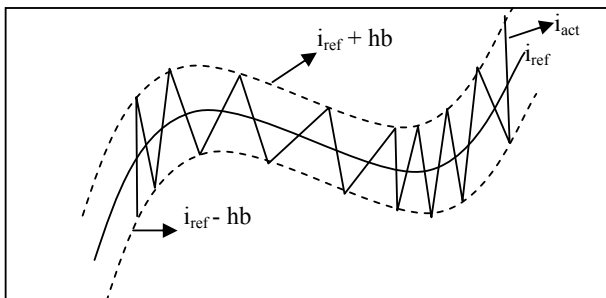

Fig. 2 Principle of tracking problem by HCC

#### B. Optimal Control Algorithm

Optimal controller is a feedback controller strategy that is designed to control the switching pattern so that the output of converter can track the reference at every sampling instant. Any deviation from the reference due to a load disturbance or nonlinear load is corrected with in one sampling interval,  $T_s$ .

Fig. 3 shows principle of tracking problem by this controller.

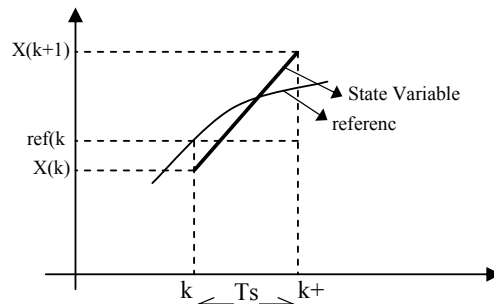

Fig. 3 Principle of tracking problem by optimal controller

The diagram of control system is shown in Fig. 4.

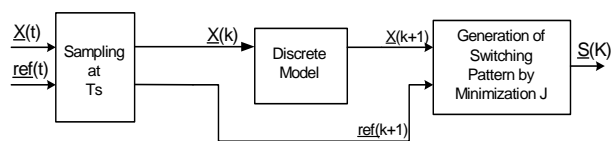

Fig. 4 Block diagram of switching pattern generation method

First the reference and actual currents of VSC are sampled with fixed sampling frequency. Then discrete model of system is applied. Switching signals is derived by minimizing the square tracking error between the reference and actual currents i.e., minimizing J.

Equation (4) shows the procedure to discrete of state variables. In this equation actual currents of VSC are as state variables so the discrete model will be as follows:

$$\begin{aligned} x_1(k+1) &= x_1(k) + \frac{T_s}{L_c} [(S_a(k) - \frac{S_a(k) + S_b(k) + S_c(k)}{3})V_{dc} - V_{sa}(k)] \\ x_2(k+1) &= x_2(k) + \frac{T_s}{L_c} [(S_b(k) - \frac{S_a(k) + S_b(k) + S_c(k)}{3})V_{dc} - V_{bs}(k)] \\ x_3(k+1) &= x_3(k) + \frac{T_s}{L_c} [(S_c(k) - \frac{S_a(k) + S_b(k) + S_c(k)}{3})V_{dc} - V_{sc}(k)] \end{aligned} \quad (4)$$

where  $V_{dc}$  is the voltage of DC side of VSC and  $T_s$  is the sampling time interval.

Equation (5) shows an objective function J, which the switching pattern should be in such a way that this objective function be minimized. In this equation  $\underline{x}_{k+1}$  and  $\underline{ref}$  are vector of discrete actual and reference compensation current of VSC respectively. Considering an initial condition  $\underline{X}(k)$ , optimal controller must generate such a switching functions  $\underline{S}(k)$  that system states  $\underline{X}(k)$ , reach to desired state,  $\underline{ref}$ .

$$J = \frac{1}{2} \|\underline{X}(K+1) - \underline{ref}(k+1)\|^2 \quad (5)$$

We have three controlling signals the Sa, Sb and Sc, so we have  $2^3$  combination of input signals. Now by check of objective function for each state, optimal controller will be derived and will applied to the switches then selected state that better at minimizing the square error between reference

and state variables.

IV. SIMULATION RESULT

The performance of the proposed scheme is evaluated by computer simulation. The simulation parameters are given as follows:

- DC side voltage of VSC 630 volt.
- Sampling time,  $T_s = 0.1$  ms
- The nonlinear loads consists of two following parts:

- 1) A balanced R-L load,  $R=15$ ,  $L=35$ mH
- 2) A diode rectifier load,  $R=35$   $L=25$ mH. This load is switched on at  $t = 0.05$  (sec).

The demonstrate the reduction in the switching number accomplished by this technique, Figs. 5 and 6 show a comparison between the optimal controller and HCC (bang-bang). It is obvious that the accumulated number of switching of optimal controller reduced compared to the HCC. Fig. 7 shows the reference compensating current and actual injected current of VSC in a phase using the proposed optimal switching method. This figure shows that it is possible to track the reference current with very fast response dynamic response and fixed frequency. It is clear that the proposed strategy can generate any desired reference current for VSC's for different application easily. Fig. 8 shows the compensated currents in utility side. This figure shows a good performance and acceptable dynamic response of proposed control strategy. Fig. 9 shows load side currents that it consist harmonics and reactive power demand.

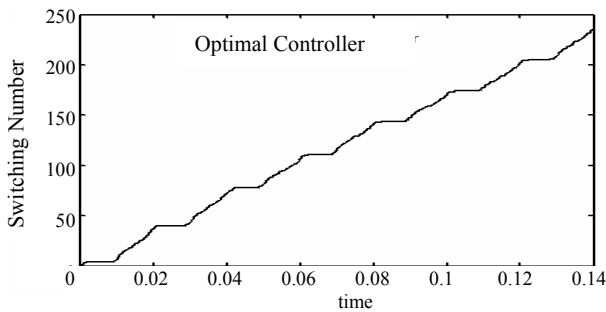

Fig. 5 Switching number by optimal controller in phase a

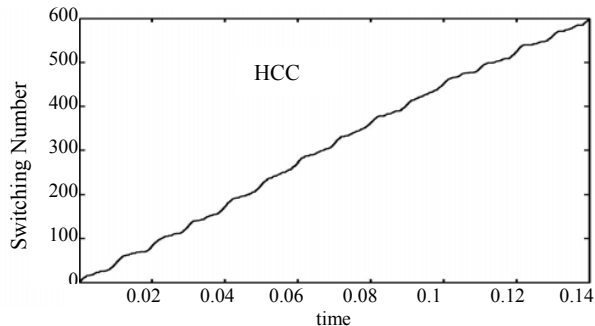

Fig. 6 Switching number by HCC controller in phase a

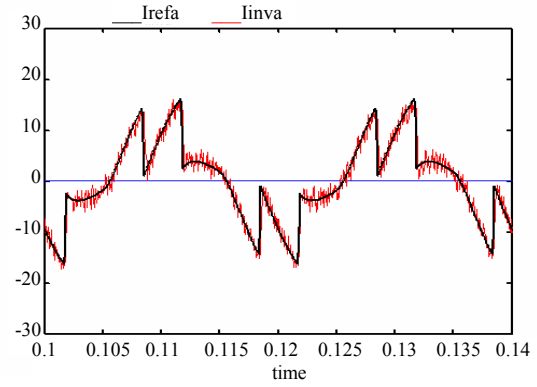

Fig. 7 Tracking of reference current by optimal controller

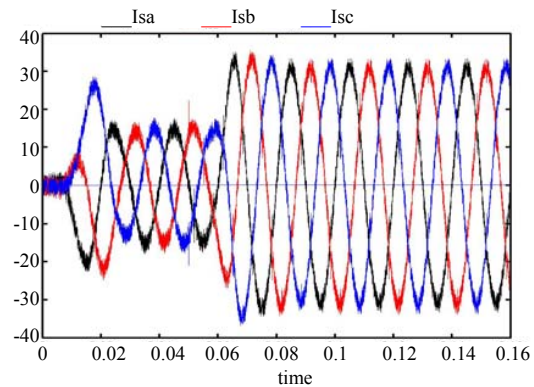

Fig. 8 Source side currents

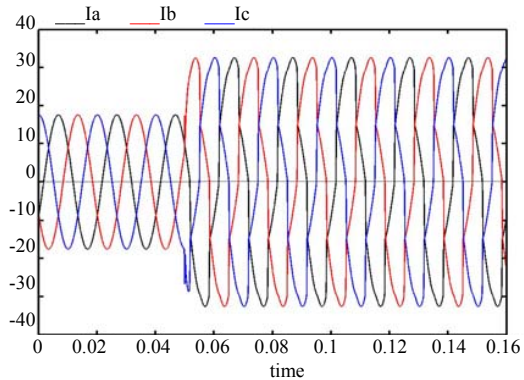

Fig. 9 Load side currents

V. CONCLUSION

A new optimal controller is presented for generation of switching pattern of VSC. The proposed optimal controller is a good operating technique to generate the gating control signals for VSC with optimal controller.

Features of this controller are simplicity, quick response and lower number of switching. In addition it has fixed frequency switching but HCC has not constant switching frequency.

REFERENCES

- [1] B. Singh, K.A.I.Haddad and A. Chandra, "A new approach to three-phase active filter for harmonics and reactive power compensation" IEEE Trans.on PWRD, Vol.13, NO.1, Feb 1998, pp.133-138.
- [2] El. Habrouk M., Darvish M.K. and Metha P., "Active power filters: A review", IEE Proc.-Elect. Power Appl., Vol. 147, No. 5, September 2000.
- [3] W. M. Grady, M. J. Samotyj and A. H. Noyola, "Survey of active power line conditioning methodologies", IEEE Trans. on PWRD, Vol. 5 , No. 3 , July 1990 , pp.1536-1542.
- [4] A. Nabae, S. O. Ware and H. Akagi, "A novel control sheme for current controlled PWM inverters," IEEE.Trans. Ind. Appl., Vol. 22, No. 4, July/August 1986, pp.697-701.
- [5] M. I. Marei , El-Saadany, M. M. A. Salama, "A new contribution into performance of active filter utilizing SVM based HCC technique," Power Engineering Society Summer Meeting, 2002 IEEE Vol.2, 21-25 July, pp.1022-1026.