

WiMAX RoF Design for Cost Effective Access Points

Haruka Mikamori, Koyu Chinen

Abstract—An optimized design of E/O and O/E for access points of WiMAX RoF was carried out by evaluating RCE. The use of the DFB-LD, a low input-impedance driving, a low distortion PIN-PD, and a high gain EPHEMT amplifier is promising the cost-effective design. For the uplink RoF design, the use of EDFA and EP-HEMT amplifiers is necessity.

Keywords— WiMAX, RoF, RCE, RAU, Access Point

I. INTRODUCTION

Worldwide Interoperability for Microwave Access (WiMAX) is a new standard for high-speed wireless communication that covers wider area than that of Wireless Local Area Network (WLAN). For the field service, many access points are required, and it is important to design them with small size, low power consumption, and high reliability. Therefore, the complicated RF modem and signal processing functions are transferred from the access points to a central control office [1]. To extend the distance between the access points and the central office, the use of Radio-over-Fiber (RoF) is suitable for the WiMAX. There have been several studies of the lower cost [2] and the high performance solutions for the RoF of WLAN. We have investigated a cost effective design for the Electrical-Optical converter (E/O) and the Optical-Electrical converter (O/E) that satisfy both the low cost and the high performance for the WiMAX RoF. In the uplink design, since the receiving signal from the mobile terminal is very low, high optical and electrical gain amplifiers are necessity.

II. WiMAX-ROF AND RAU

The WiMAX-RoF link is connecting between the Central Office (CO) and the Access Point, by using a Single Mode optical Fiber (SMF). For the distribution of the WiMAX access points, it is important to design the access points with low power consumption, small mechanical size, highly reliable, long distance installation, and low cost. Therefore, the signal processing function such as the frequency up-down converter,

modulator and de-modulator, and A/D converter shall be transferred to the CO, and the access point is modified to the remote antenna unit (RAU) that has a transceiver antenna, and E/O and O/E converters. Therefore, it is important to design the cost-effective E/O and O/E converters, for the cost-effective RAU. Since there are many factors to reduce the cost, we focused on laser type, input impedance, receiver type, and pre-amplifiers. Regarding the uplink design of the RoF, since the received signal is very low, the use of an optical amplifier is considered to compensate the optical loss in the transmission.

III. E/O AND O/E CONVERTERS

A. Design of E/O converter

Two different types of 1310 nm InGaAsP lasers of Distributed-Feedback laser diode (DFB-LD) and Fabry Perot type lasers diode (FP-LD) were compared for the E/O converter. The package of the laser was Transmitter Optical Sub-assembly (TOSA) that had no pigtailed optical interface due to low cost design. We investigated if the electrical and optical conversion efficiency was increased with adjusting the input impedance of the E/O converter. The input impedance of the lasers was adjusted on a network analyzer by changing the R, C, and L elements at the Radio-Frequency (RF) line of the Bias-Tee, as shown in Fig.1. After the input impedance adjustment, the E/O conversion efficiency was measured by a light-wave optical component analyzer (N4373A+N5230A, Agilent). The low-impedance input laser modulation showed about 5 dB higher E/O conversion efficiency than that of 50 Ω input impedance laser, as shown in Table I. Since the length of the RF coaxial cable is about 50cm, the electrical reflectance does not affect the E/O conversion efficiency.

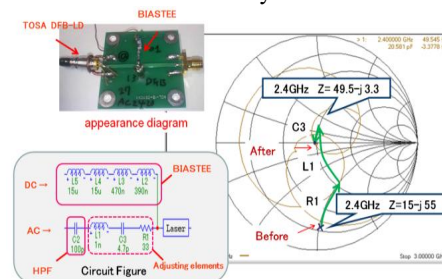

Fig.1 TOSA type E/O converter with Bias-Tee and adjusted input impedance on Smith Chart

H. Mikamori with the Okinawa National College of Technology, 905 Henoko, Okinawa, JAPAN (e-mail: ac104608@edu.okinawa-ct.ac.jp).

K.Chinen is with the Okinawa National College of Technology, 905 Henoko, Okinawa, JAPAN (corresponding author to provide phone: +81-980-55-4143; fax +81-980-55-4012; e-mail: k.chinen@okinawa-ct.ac.jp).

Table I shows the O/E converters that were fabricated to investigate the optimum design of the LD structures, input impedance, and E/O conversion efficiency.

TABLE I
E/O CONVERTERS

Name	LD structure	Input Impedance [Ω]	E/O conversion efficiency[dB]
DFB-Low	DFB	7-j2.07	-8.3
DFB-50	DFB	49.5-j3.3	-12
FP-Low	FP	11-j3.95	-13
FP-50	FP	50-j0.093	-18

B. Design of O/E converter

For the cost-effective solution of the design of the O/E converter, we focused on the PIN-PD structure and pre-amplifier gain. Four different types of configuration of the O/Es were investigated. A linear-PIN-PD designed for 2 GHz analog modulation, and a high speed PIN-PD designed for 2.5 Gb/s or 10 Gb/s were used. Two different types of packages of the coaxial pigtailed type and the ROSA type were used. Four different types of pre-amplifiers that had multi stages Enhancement-Mode Pseudomorphic High Electron Mobility Transistor (EP-HEMT) or a combination of Trans-impedance Amplifier (TIA) and the EP-HEMT amplifier were used. The reason of the use of the EP-HEMT is to achieve low voltage single power supply, low noise figure, and high power gain. A typical O/E with ROSA PIN-PD and EP-HEMT pre-amplifier is shown in Fig.2. Table II shows the O/E converters that were fabricated with various parameters of those components to investigate the optimum performance.



Fig.2 Configuration of ROSA PIN-PD with Pre-Amplifier

TABLE II
O/E Converters

Name	PIN-PD Type	Amp Gain [dB]	O/E conversion efficiency [dB]
PIN1-AMP1	PIN-Pigtail (2GHz analog)	17	19
PIN2-AMP2	PIN-TIA(ROSA) (2.4Gb/s digital)	15	33.8
PIN3-AMP3	PIN-TIA (10Gb/s digital)	Zt= 1.5k Ω	35
PIN1-AMP4	PIN-Pigtail (2GHz analog)	46	44.8

IV. EVALUATION OF E/O AND O/E

A. RCE MEASUREMENTS AND EXPERIMENTAL SET-UP

In the evaluation of the WiMAX RoF link, the WiMAX signal was modulated with BPSK, QPSK, 16QAM, and 64QAM[3]. A constellation of those modulations is shown in Fig.3. The received signal quality was evaluated by using Relative Constellation Error (RCE) that indicated average-error for all modulations. The WiMAX signal was generated by a Vector Signal Generator (VSG, E4438C), and was converted to optical signal by the E/O converter. After the transmission, the optical signal was converted to electrical signal by O/E converter. The received signal was analyzed by a Vector Signal Analyzer (VSA). The experimental set-up is shown in Fig.4.

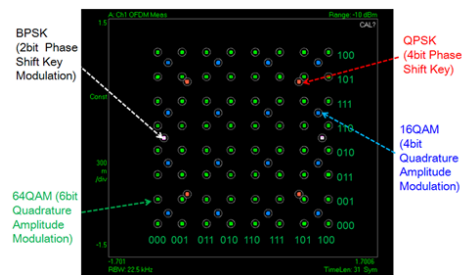

Fig.3 WiMAX signal constellation

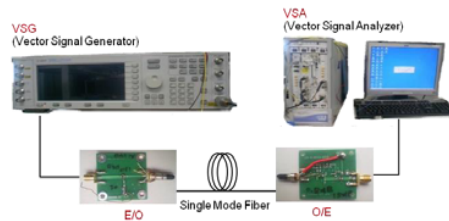

Fig.4 Experimental set-up for evaluation of the E/O and the O/E in the RCE measurements on the WiMAX –RoF

B. EXPERIMENTAL RESULTS OF E/O MEASUREMENTS

The WiMAX downlink standard of the IEEE802.16 requires -30 dB as the maximum value for the RCE at the access point. The RCE was measured for the FP-LD, the DFB-LD, the low input impedance, and the 50 Ω input impedance are shown in Fig.5. The SMF length is 30km. The DFB-LD showed the lowest RCE. This is due to the lower relative intensity noise (RIN, about -155 dB/Hz) of the DFB-LD, compared with the FP-LD.

The low input-impedance DFB-LD shows lower RCE, as shown in Fig.6. This is due to the high electrical and optical conversion efficiency (see Table I).

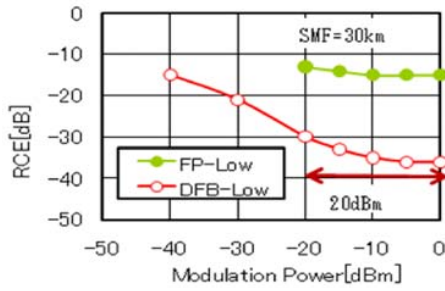

Fig.5 RCE measurement of two different types of LDs

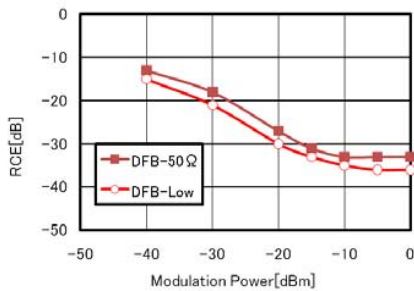

Fig.6 RCE measurement for two different impedances

C. EXPERIMENTAL RESULTS OF O/E MEASUREMENTS

Four different types of O/E converters of the Analog-PIN with low gain (PIN1-AMP1), the Analog-PIN with high gain (PIN1-AMP4), the Digital-PIN (PIN2-AMP2), and the Digital-high speed-PIN (PIN3-AMP3) were evaluated on the WiMAX RoF. The Analog-PIN (PIN1) showed the lower RCE in all modulation powers. This is due to the high linearity in the O/E conversion of the Analog-PIN that shows low distortion results, as shown in Fig.7[4].

The high gain O/E (PIN1-AMP4) showed lower RCE than that of the low gain O/E (PIN1-AMP1) . In case of using the analog PIN the higher gain increased the SNR that reduced the RCE.

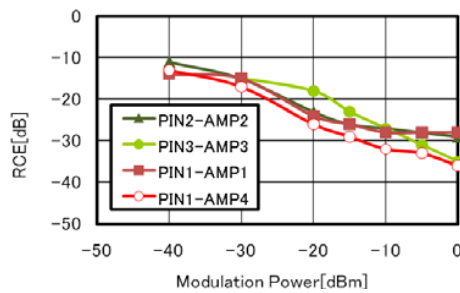

Fig.7 RCE measurement of four different O/E converters

V. UPLINK RoF ON PON

A passive optical network (PON) is considered for the cost-effective WiMAX RoF to split single RoF link to several RAUs, as shown in Fig. 8[5]. In case of the downlink RoF, the mobile terminals, such as mobile phone, smart phone, and personal computer, emit low signal power when the users are far from the RAU. Since the received power at the antenna of the RAU is very low, the uplink has to be designed so that the weak signal is received and amplified at the CO.

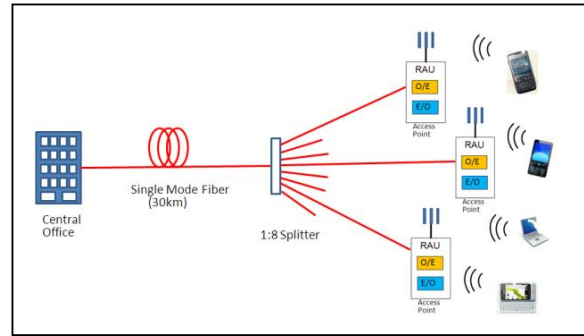

Fig.8 A passive optical network (PON) to distribute single RoF link to several Remote Antenna Unit (RAU). The uplink signal power is very low when the mobile terminal is far from the RAU.

In case of using the PON system in the RoF, the transmitted signal is lowered at the optical splitter. Therefore the optical loss has to be compensated by amplifiers. We considered to use an optical amplifier at the CO to amplify the low received power. The performance of the optical amplifier, such as Erbium Doped Fiber Amplifier (EDFA), was well designed at a wavelength of 1550nm, the RoF link for the PON was designed with the 1550nm wavelength. To amplify the electrical signal at the antenna receiver in the RAU and amplify the O/E output signal at the CO, we used a low noise and high gain amplifier. The low noise amplifier (LNA) was designed by using EP-HEMT.

An RoF experimental setup was constructed to evaluate the uplink signal, as shown in Fig. 9. The WiMAX IEEE802-16 signal was generated with the VSG. The WiMAX signal was amplified with a high gain (28dB) and low noise figure (NF:1.38dB) LNA that was designed with EPHEMT. The LNA was also the laser driver of the 1550nm DFB-LD that was designed to have a linear E/O conversion for analog transmission. The 1550nm DFB-LD had a coaxial pigtail type package and operated under un-cooled condition, because the lower cost of the E/O was required for the RAU. Since the E/O output was the uplink signal, the output signal is input to the 8:1 optical splitter. The optical splitter had an 11dB optical loss for each port. The 1:8 splitter has one output port. The optical output was connected to a 30km SMF. After the 30km transmission the signal was input to the EDFA that was installed in the CO. The EDFA amplified the optical signal to compensate the loss of the 1:8 splitter and 30km SMF. The output optical signal was received with a linear PIN photodiode.

This PIN-PD was also designed to have a linear O/E conversion for analog transmission. The O/E had a coaxial pigtail package. The output of the PIN-PD was connected to a high gain (26dB) and a low noise figure (NF:1.45dB) LNA that was designed with multistage EP-HEMT. The output was connected to the VSA to evaluate the RCE.

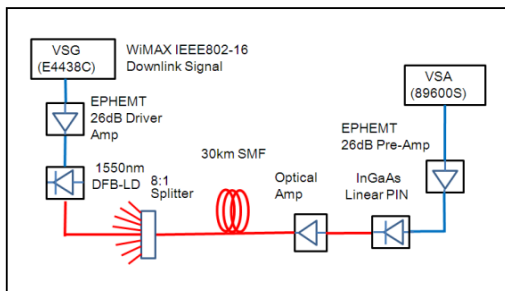

Fig.9 A WiMAX RoF link set-up for PON uplink evaluation. The E/O was installed in the RAU, and the optical amplifier (EDFA) and O/E were installed in the CO.

The modulation power of the VSG was varied from -50 to -20dBm. The RCE decreased with the modulation power, then reached to the minimum value, and the RCE increased, as shown in Fig.10. Since the SNR was increased when the modulation power increased, the RCE decreased. But high modulation power than -30dBm caused an optical distortion at the DFB-LD. It was also considered that the optimization of the operation of the EDFA was necessary, since the EDFA had a large noise figure. The EDFA gain was also changed between 7.43dB and 19dB during the RCE measurements. There was also an optimum gain of the EDFA to achieve the low RCE. When the EDFA gain increased from the 7.43dB, the RCE reached the lowest value at a gain of 12dB and at the modulation power of -30dBm. After that the RCE increased. This means that the higher EDFA gain brings the higher noise. Therefore the optimum EDFA gain was around 12dB for the RCE.

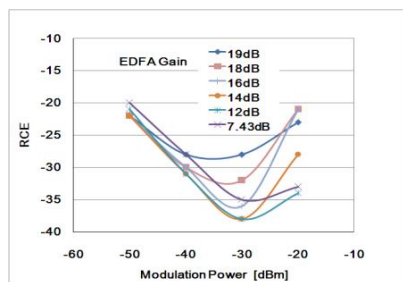

Fig.10 RCE measurements vs. DFB-LD modulation powers with various EDFA gains

The measured data are plotted on another format, as shown in Fig. 11. The optimum EDFA gain was around 12dB when the modulation power was lower than -30dBm. When the modulation power was -20dBm, the RCE increased drastically with the EDFA gain. This was due to an optical nonlinearity at high input power and at high EDFA gain operation. Therefore a low gain operation less than 12dB was optimum to achieve lower RCE. Because the SNR was low when the modulation power was lower than -30dBm, the minimum received power at the RAU was -40dBm so as to transmit the signal over 30km SMF and 1:8 optical splitter. More low received power was able to be achieved by redesign of the SMF length and the numbers of the optical splitter.

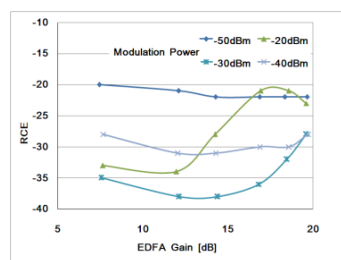

Fig.11 RCE measurements result with various EDFA gains.

VI. CONCLUSIONS

At the WiMAX RoF transmission less than 40km, to satisfy the lower cost and the RCE less than -30dB, it is suitable to use the DFB-LD, the lower input impedance driving, an analog PIN-PD, and a high-gain EP-HEMT amplifier, for the design of the E/O and the O/E converters for the access points.

In case of the uplink WiMAX RoF, it is necessary to use the 1550nm DFB-LD, EDFA, and the high gain and low noise EP-HEMT amplifiers that are used for the laser driver and the pre-amplifier of the PIN receiver.

REFERENCES

- [1] H. AlRaweshidy and S. Komaki, Radio over Fiber Technologies for Mobile Communications Networks (Artech House, 2002) Chap.4 .
- [2] Andrey Kobayakov. et al., "802.11a/g WLAN Radio Transmission at 1.3um over 1.1 km Multi-mode and >30km Standard Single-mode Fiber Using InP VCSEL", in Proc. ECOC 2006, (Cannes, France, 2006), Paper Tu1.6.1.
- [3] Zerihun Abate, "WiMAX RF Systems Engineering", (Artech House, 2009)
- [4] Brilliant Avigdon, "Digital and analog fiber optic communications for CATV and FTTX applications", John Wiley & Sons. Inc., 2008)
- [5] Prasanna A.Gamage, et. al., "Power Optimized Optical Links for Hybrid Access Networks", OECC (Sydney, Australia, 2008)