

Conventional Design and Simulation of an Urban Hybrid Bus

A. Khanipour, K. M. Ebrahimi, and W. J. Seale

Abstract—Due to heightened concerns over environmental and economic issues the growing importance of air pollution, and the importance of conserving fossil fuel resources in the world, the automotive industry is now forced to produce more fuel efficient, low emission vehicles and new drive system technologies. One of the most promising technologies to receive attention is the hybrid electric vehicle (HEV), which consists of two or more energy sources that supply energy to electric traction motors that in turn drive the wheels. This paper presents the various structures of HEV systems, the basic theoretical knowledge for describing their operation and the general behaviour of the HEV in acceleration, cruise and deceleration phases. The conventional design and sizing of a series HEV is studied. A conventional bus and its series configuration are defined and evaluated using the ADVISOR. In this section the simulation of a standard driving cycle and prediction of its fuel consumption and emissions of the HEV are discussed. Finally the bus performance is investigated to establish whether it can satisfy the performance, fuel consumption and emissions requested. The validity of the simulation has been established by the close conformity between the fuel consumption of the conventional bus reported by the manufacturer to what has achieved from the simulation.

Keywords—Hybrid Electric Vehicle, Hybridization, LEV, HEV.

I. INTRODUCTION

THE development of internal combustion engine (ICE) vehicles is one of the greatest achievements of modern technology. Conventional vehicles with ICE provide good performance and long operating range; however they have caused and continue to cause serious problems for the poor fuel economy, environment pollution and human life. Reducing fuel consumption and emissions is one of the most important goals of modern design. The Hybridization of a conventional combustion engine vehicle with an advanced electric motor drive may greatly enhance the overall efficiency and achieve higher fuel economy and reduced emissions [2]. Transit buses are considered to be the best candidates for hybrid application because they normally operate on predictable routes with frequent starts and stops. A hybrid propulsion system is better suited for transit buses than private cars because they operate at lower speed, limited acceleration, less road grades and ample space available for batteries [6].

Authors are with School of Engineering, Design and Technology, University of Bradford, UK (e-mail: A.khanipour@bradford.ac.uk).

II. HYBRID ELECTRIC VEHICLE CONCEPTS

A hybrid vehicle may be defined conveniently as a vehicle having two power sources for propulsion. Usually, one of these sources derives its power from fuel, whilst the other relies on stored energy which can be used for extra power at various stages during a journey. The stored energy may also be replenished by the fuelled power source, or by recovering energy that would normally be lost in braking as shown in Figs. 1 and 2 [5]. This combination represents a cross between a conventional automobile and an electric vehicle. Normally, the target of this vehicle is to compete with the performance of the conventional and increased fuel efficiency and enhanced potential of reductions in emissions. Essentially, by using a hybrid system, a considerably smaller main engine can be used than in the corresponding conventional vehicle [5].

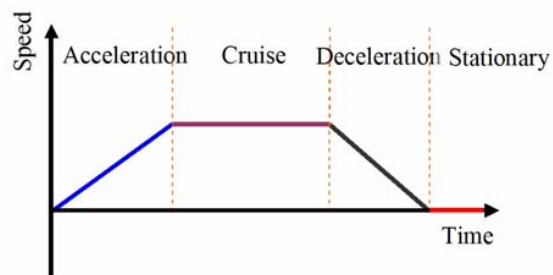

Fig. 1 Ideal speed profile for stop/start cycle

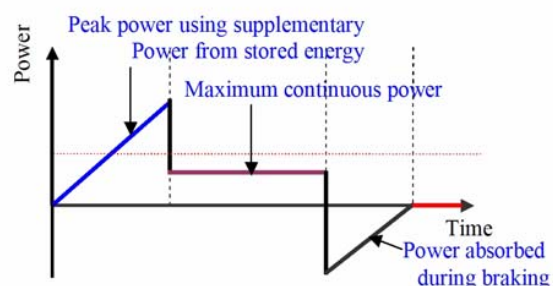

Fig. 2 Corresponding theoretical power demand by the propulsion

III. CLASSIFICATION OF HYBRID ELECTRIC VEHICLES

The architecture of a hybrid vehicle is loosely defined by routes of the power flow from the energy source to cars wheels. Traditionally two HEV configurations have been defined: series and parallel. In series hybrid drive train, the EM propels the vehicle while the ICE and generator generate electric power. In parallel structure, either the EM or ICE or even both can drive the vehicle. Note however in 2000, some newly introduced HEVs do not fill in to this classification. Therefore, HEVs are now classified into four kinds: series hybrid, parallel hybrid, series-parallel hybrid, and complex hybrid. The parallel hybrid is more efficient of satisfying high road power demands (high speed or acceleration), while series is more efficient for large energy demands. For public transportation purposes, where large weight is of more concern than high acceleration, the series propulsion strategy becomes more efficient and simpler [6]. Thus, in this research, the series configuration drive train has been preferred.

IV. GENERAL DESCRIPTION OF VEHICLE MOVEMENT

Designing and analyzing of each part of vehicle rely on some information about its performance and properties. According to Newton's second law, vehicle acceleration can be written as:

$$\frac{dV}{dt} = \frac{\sum F_t - \sum F_r}{M \delta} \quad (1)$$

Where $\frac{dV}{dt}$ is vehicle acceleration, $\sum F_t$ is the total tractive effort of the vehicle, $\sum F_r$ is the total resistance, M is the

total mass of the vehicle and δ is the mass factor, which is an effect of rotating components in the power train. All of the vehicle resistances will be discussed in the following sections.

V. WHEEL ROLLING RESISTANCE

The rolling resistance of tyres on hard surfaces is primarily caused by hysteresis in the tyre materials. This is due to the deflection of the carcass while the tyre is rolling. On soft surfaces; the rolling resistance is primarily caused by deformation of the ground surface. The rolling resistance force can be written as:

$$F_r = M .g .f_r .\cos \alpha \quad (2)$$

where F_r is the rolling resistance force, M is Bus Mass, g is gravity acceleration, f_r is rolling resistance coefficient and α is the road angle.

The power required to overcome the rolling resistance is:

$$P_r = F_r .V \quad (3)$$

where P_r is the power required to overcome the rolling resistance, F_r is the resistance force and V is the vehicle speed.

VI. AERODYNAMIC DRAG

A vehicle travelling at a particular speed in air encounters a force resisting its motion. This force is referred to as aerodynamic drag. It mainly results from two components: shape drag and skin friction and is expressed as:

$$F_w = \frac{1}{2} \rho A_f C_D V^2 (1 + C_w) \quad (4)$$

The power required to overcome aerodynamic drag force is:

$$P_w = \frac{1}{2} \rho A_f C_D V^3 (1 + C_w) \quad (5)$$

where F_w is the aerodynamic drag force, C_w is the wind speed coefficient, ρ is the air density, A_f is the frontal area of the vehicle, C_d is the coefficient of air drag and V is velocity of the car.

VII. GRADING RESISTANCE

When a vehicle goes up or down a slope, its weight produces a component which is always directed to the downward direction. This component either opposes the forward motion (grade climbing) or helps the forward motion (grade descending). In vehicle performance analysis, only uphill operation is considered. This grading force is usually called grading resistance force and can be expressed as:

$$F_g = M .g .\sin \alpha \quad (6)$$

The power required for climbing a hill inclined at an angle α is:

$$P_g = M .g V .\sin \alpha \quad (7)$$

where M is the total mass of the vehicle, V is the vehicle speed, g is the gravity acceleration and α is the road angle.

The total vehicle resistance force and dynamic equation can be expressed as equations (8) and (9):

$$F_{tr} = F_r + F_w + F_g = Mg(f_r \cos \alpha + \sin \alpha) + \frac{1}{2} \rho A_f C_D V^2 (1 + C_w) \quad (8)$$

$$M \frac{dv}{dt} = (F_{tf} + F_{tr}) - (F_{rf} + F_{rr} + F_w + F_g) \quad (9)$$

where $\frac{dv}{dt}$ is the linear acceleration of the vehicle,

F_{rf} and F_{rr} are the rolling resistance of front and rear tyres respectively, F_w is the aerodynamic drag, F_g is the grading resistance and F_{tr} , F_{tf} are the tractive effort of the front and rear tyre respectively.

VIII. COMPONENTS SIZING

The major components in a series hybrid train include traction motor, engine/generator, and PPS (Peaking power source). The sizing of the power rating of these components is the first and most important step in the whole system design. The total tractive power (KW) for accelerating the vehicle from zero to speed V_f in t_a seconds can be obtained as:

$$P_t = P_{wheel} = \frac{1}{1000} \left[\frac{\delta M}{2t_a} (V_f^2 + V_b^2) + \frac{2}{3} MgV_f (f_r \cos \alpha + \sin \alpha) + \frac{1}{5} \rho C_D A_f V_f^3 \right] \quad (10)$$

The power rating of electric motor (KW) in the flat road is:

$$P_{EM} = \frac{1}{1000 \eta_t} \left[\frac{\delta M}{2t_a} (V_f^2 + V_b^2) + \frac{2}{3} MgV_f (f_r \cos \alpha + \sin \alpha) + \frac{1}{5} \rho C_D A_f V_f^3 \right] \quad (11)$$

The first term of above mentioned equations, represents the power used to accelerate the vehicle mass, and the second and third terms represent the average power for overcoming the tyre rolling resistance and aerodynamic drag.

The electric motor torque is:

$$T_{EM} = \frac{P_{EM}}{\omega_{EM}} = \frac{60}{2\pi RPM_{EM}} P_{EM} = \frac{30P_{EM}}{\pi RPM_{EM}} \quad (12)$$

where M is the total mass of the vehicle (kg), g is the gravity acceleration (m/s^2), α is the road angle, δ is the mass factor,

t_a is the accelerating time (sec.), V_f is the final acceleration speed (m/s), V_b is the vehicle speed at EM's base speed (m/s), η_t is the transmission efficiency, C_D Aerodynamic drag coefficient, ρ is the air density (kg/m^3), RPM_{EM} is the electric motor speed (1/Min.), A_f is the Vehicle frontal area (m^2) and f_r is the Rolling resistance coefficient.

Internal Combustion Engine and Generator in a series hybrid drive train are used to supply steady state power in order to prevent the PPS from being discharged completely. In the design of the engine/generator, two driving conditions should be considered: Driving for a long time with constant speed, such as highway driving between cities, and driving with a frequent stop-go driving pattern, such as driving in cities. At a constant speed, the power output (KW) from the engine/generator can be expressed:

$$P_{e/g} = \frac{1}{1000 \eta_t \eta_m} \left[\frac{2}{3} MgV_f (f_r \cos \alpha + \sin \alpha) + \frac{1}{5} \rho C_D A_f V_f^3 \right] \quad (13)$$

where η_m is the electric motor efficiency.

When the vehicle is driving in a stop and go pattern in urban areas, the power that the engine/generator produces should be equal to or slightly greater than the average load power in order to maintain balance PPS energy storage. The average load power can be expressed as:

$$P_{ave} = \frac{1}{T} \int_0^T (Mgf_r + \frac{1}{2} \rho C_D A_f V^2) \mathcal{V} dt + \frac{1}{T} \int_0^T \delta M \frac{dV}{dt} dt \quad (14)$$

The first term in equation is the average power consumed to overcome the tyre rolling resistance and aerodynamic drag and the second term is the average power consumed in acceleration and deceleration.

In the design of an engine/generator system, the power capability should be greater than, or at least not less than, the power that is needed to support the vehicle driving at a constant speed (highway driving) and at average power when driving in urban areas. In actual design, a typical urban drive cycles may be used to predict the average power of the vehicle.

Battery sizing is based on an "energy management" approach. It is necessary to ensure that at any point on a journey cycle, the amount of energy in the storage device lies between its maximum and lower limits. It is obvious that by more generated energy from batteries, the vehicle can operate more in fully electric operation and the results are reduction of fuel consumption and air pollution, so it is necessary to select the batteries in the best state of engine performance and to reduce the engine work duration.

The battery must be capable of delivering sufficient power to the traction motor at any time. At the same time; it must store sufficient energy to avoid failure of power delivery due

to too deep discharging. To fully utilize the electric motor power capacity, the total power of the engine/generator and battery should be greater than or at least equal to the rated maximum power of the electric motor. Thus the power capacity of the battery (KW) can be expressed as:

$$P_{PPS} \geq \frac{P_{EM,Max}}{\eta_m} - P_{e/g} \eta_g \quad (15)$$

The energy capacity of the battery pack is determined by the length of time that the vehicle is required operate as pure electric in a specific driving .Having calculated the power, the designer must decide on the amount of pack voltage and thus from which the required amperage from the battery pack is obtained by the following equation:

$$I_{Batt} = \frac{P_{Batt}}{V_{Batt}} \quad (16)$$

The amperage and multiplying it by the amount of pure electric mode time (hr), the energy capacity of the battery pack is evaluated as:

$$Q_{Batt} = I_{Batt} t_{PEM} \quad (17)$$

where $P_{EM,MAX}$ is the maximum EM power (KW), η_m is the EM efficiency, $P_{e/g}$ is the engine/generator power (KW) , η_g is the generator efficiency, P_{Batt} is the battery pack power (W) , P_{pps} is the power capacity of the battery (KW), V_{Batt} is the battery pack voltage (V) , I_{Batt} is the battery pack amperage (A) and t_{PEM} is the vehicle pure electric mode duration (hr) .

Table I presents some technical specification which has been used for the components sizing and conventional design of the bus.

TABLE I
TECHNICAL SPECIFICATIONS

Drag coefficient	$C_D = 0.79$
Wind speed coefficient	$C_W = 0.2$
Rolling resistance coefficient	$f_r = 0.01$
Frontal area(m ²)	$A_f = 6.75$
Acceleration Time (sec.)	$t_a = 60$
Transmission efficiency	$\eta_t = 0.85$
Electric motor efficiency	$\eta_m = 0.90$
Generator efficiency	$\eta_g = 0.90$
Bus total mass (kg)	$M = 18000$
Mass factor	$\delta = 1.035$
Air density (kg/m ³)	$\rho = 1.3$
Maximum Speed (Km/h)	$V_{Max} = 80$
Final acceleration speed (Km/h)	$V_f = 80$

Figs. 3 to 6 present electric motor, internal combustion engine and battery specification versus vehicle speed on the different slopes.

Fig. 3 shows the maximum EM power in level surface for achieves to 80 km/h is 144.1 kW and also for achieve to 20 km/h on slope=14% is 120 kW.

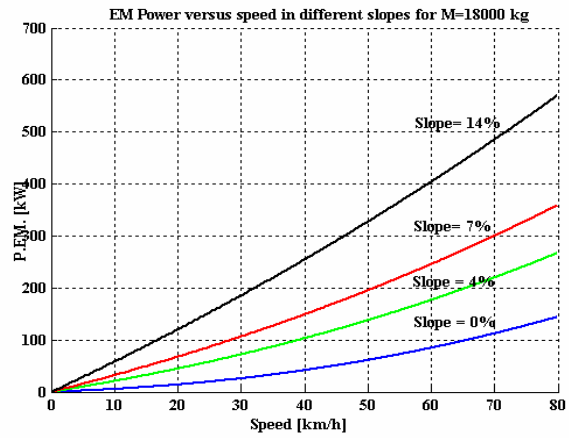

Fig. 3 EM power versus vehicle speed on the different slopes.

Fig. 4 shows that the maximum EM torque in level surface for achieve to 80 km/h is 189.4 N.M and also for achieve to 20 km/h on slope=14% for is 615 N.M.

Fig. 5 shows that 53.9 kW of engine power can be able of supporting the bus at 80 Km/h on a flat road, 27 Km/h on 4% slope, 17 Km/h on 7% slope and 8 Km/h on 14% slope.

Fig. 6 shows the maximum battery power in level surface for achieves to 80 km/h is 111.5 kW and also for achieve to 20 km/h on slope=14% is 20 Kw.

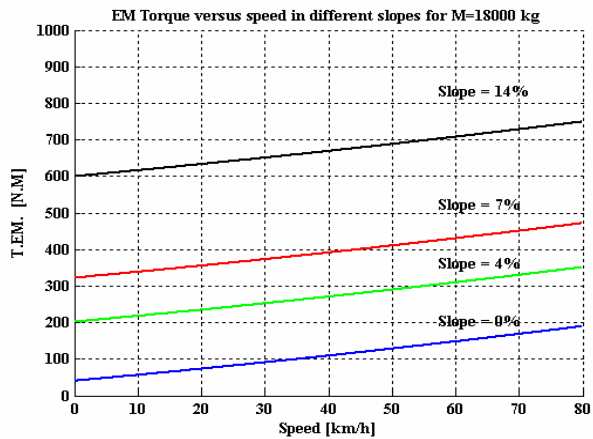

Fig. 4 EM Torque versus vehicle speed on the different slopes

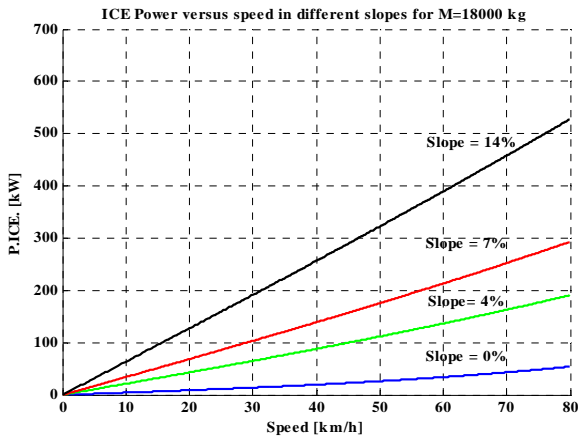

Fig. 5 ICE power versus vehicle speed on the different slopes

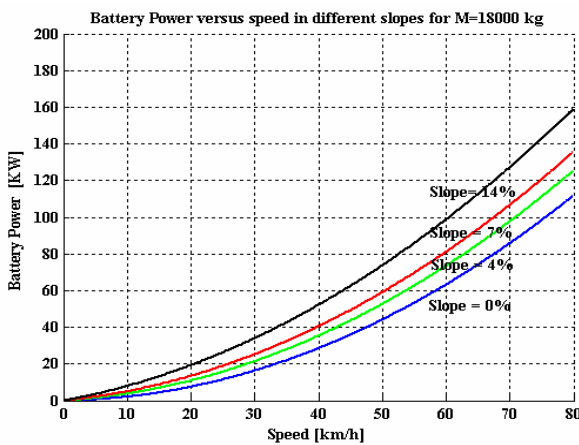

Fig. 6 Battery Power versus vehicle speed on the different slopes

IX. EFFECT OF DIFFERENT COMPONENTS ON BUS PERFORMANCE

▪ Effect of Bus Weight

Table II shows the tractive effort that the bus need to achieve to a demand speed is tightly depend on the bus weight. For instance in M=15000 kg, the bus need 15500N tractive effort, it increases to 18000 N when the bus weight is 18000 kg and 22000 N for M=21000 kg on the slope 14%. In continuous operating mode to achieve to 80 km/h on a flat road it needs 4400 N for M=15000 kg and 5500 N for M=18000 kg and 63000 N for M=18000kg.

Table II present the summary results of parameters in different weight and slopes.

TABLE II
VEHICLE PARAMETERS AT DIFFERENT WEIGHT AND SLOPES

Vehicle Parameters	Vehicle Weight(kg)	For achieve to 20 km/h on slope 14%	For achieve to 80 km/h			
			0%	4%	7%	14%
Maximum Electric Motor Power (KW)	15000	100	123	225	302	478
	18000	120	144	267	359	570
	21000	140	165	308	415	662
Maximum Electric Motor Torque (N.M)	15000	520	162	296	397	628
	18000	615	189	351	471	749
	21000	715	217	405	546	870
Maximum ICE Power (KW)	15000	110	48	162	247	442
	18000	120	54	190	292	527
	21000	150	60	219	338	611
Maximum Battery power (KW)	15000	18	93	105	113	133
	18000	20	112	125	135	159
	21000	22	130	146	158	185
Maximum Tractive Effort (KN)	15000	15.5	4.4	8.6	11.5	18.3
	18000	18	5.5	10.2	13.7	21.8
	21000	22	6.3	11.8	15.9	25.3

▪ Effect of Grade

Table II shows, the bus tractive effort is strongly depend to road slope. It's clear that for achieve to 80 km/h it need 5500 N on the flat road, 10200 N on the 4% slope, 13700 N on the 7% slope and 21800 N on 14% slope. It obvious that the tractive effort increases about 400% when the slope increases from 0% to 14%.

▪ The Most Critical Condition

The most critical condition appears when the batteries can no longer supply the EM and only the engine/generator should feed the EM to propel. Table II shows to achieve to speed 20 km/h on slope 14%, 120 kw and to achieve 80 km/h on the flat road, 54 kw ICE power is needed, if suppose the ICE fixed power around 120 kw and a total efficiency between engine and EM equal to 90 %, the effective power on the EM input shaft is about 108 kW. It means that when the batteries are out of work, the engine / generator supply 108 kW power at the EM input shaft.

As it can be seen in Fig. 7, this power can move the bus at 18, 32, 43, and 68 km/h on 14%, 7%, 4%, and level surfaces respectively.

These results are valid for the worst condition when the bus is fully loaded. It means the components are chosen properly and can satisfy all bus requirements to have suitable performance in all possible conditions.

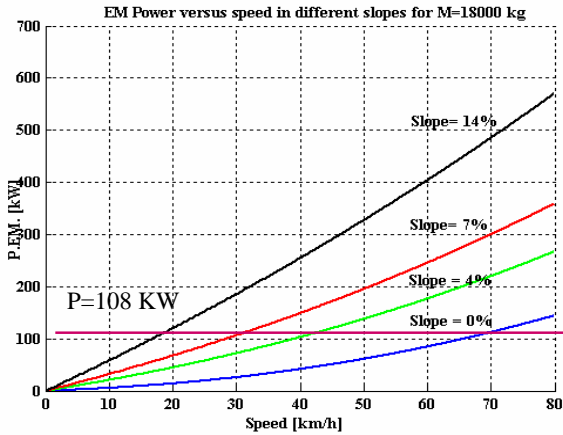

Fig. 7 The electric motor power in most critical condition

X. HYBRID BUS COMPONENTS LAYOUT

The final structure that design for controller, electrical and mechanical parts is shown in Fig. 8. By referring to mentioned figure, for generating the acceleration force for the bus, two EM are used and each motor have their own inverters and controllers that are controlled by central control unit. These two motors are joined to the differential axle and to the wheels by a coupling gearbox. For batteries, a charger has performed which can charge the batteries by city electricity power during the night. According to this information, each part has their own controller that all of them are controlled by central control unit.

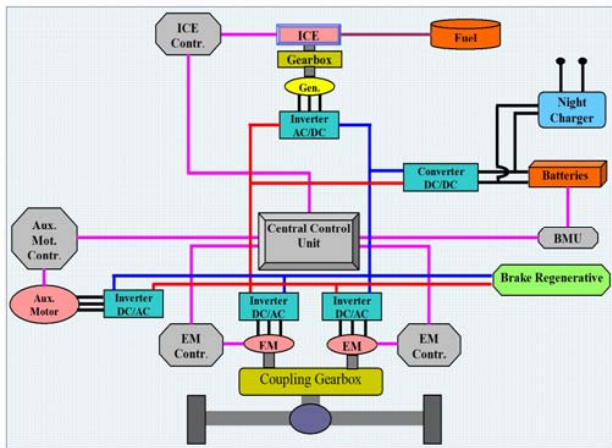

Fig. 8 Final structure with it's electrical, mechanical and control joints

XI. MODELLING OF HYBRID SYSTEM IN ADVISOR

The Advanced Vehicle Simulator (ADVISOR) was designed as an analysis tool to assist the US Department of Energy (DOE) in developing technologies for hybrid electric vehicles through Hybrid Electric Vehicle Propulsion System contracts with Ford, General Motors, and Daimler Chrysler.

Its primary role is to highlight the system-level interactions of hybrid and electric vehicle components and their impacts on the vehicle performance and fuel economy. ADVISOR was created in the Matlab/Simulink environment. Matlab provides an easy-to-use matrix-based programming environment for performing calculations while Simulink can be used to represent complex systems graphically using block diagrams [10].

Model and Code used in Simulink

Each component has a MATLAB file containing its specifications in ADVISOR. In this section the simulation for series hybrid bus is performed. The simulation of AC motor is performed by two 1PV5138-4WS24-W12 Siemens motor. A 1FV51139WS28 Siemens generator is used as the generator. For ICE an OM 906 LA diesel motor with 205 kW power is simulated and Maxxima DC 900 batteries is used as the battery packs. The ON-OFF (Thermostatic) control strategy controls the engine and for other hybrid electric parts the available information in ADVISOR is used.

Drive Cycle

A drive cycle is needed to investigate the performance of each component of the hybrid electric bus. The combination of two CBD14 drive cycle has been used for simulation which this cycle is repeated two times.

Simulation Results

Figs. 9 and 10 show the results of the components simulation in the mentioned drive cycle with assumption that the bus travels on the level surface. Fig. 9 shows that the bus is capable to pass the drive cycle. Fig. 10 shows that the bus travels more than half of the path in pure electric mode and it is so effective for emission and fuel consumption reduction and also the generator is capable to keep the SOC of the battery pack over the 40%.

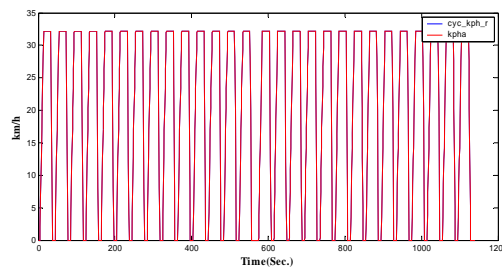

Fig. 9 Bus speed history at no slope condition versus time

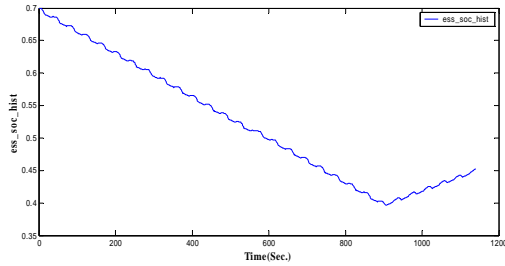

Fig. 10 SOC history at no slope condition versus time

Fig. 11 shows the simulation results for SOC history in the mentioned drive cycle with assumption that the bus travels on the level with 4% slope. The figure shows that the bus can move at least 35% of its total travelling time in pure electric mode and the generator is capable to keep the SOC of the battery pack over the 35%.

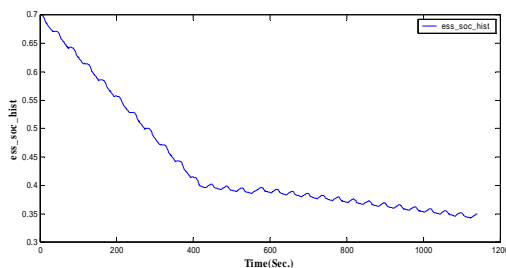

Fig. 11 SOC history at 4% average Road slope versus time

The emission and fuel consumption of the hybrid electric bus has been presented and the results are compared with the same parameters of the conventional diesel bus (Table III).

TABLE III
EMISSION AND FUEL CONSUMPTION OF THE HYBRID AND CONVENTIONAL BUS
AT NO SLOPE

Bus type & Test conditions	Emission (grams/km)			Fuel Consumption (lit/100km)
	HC	CO	NO _x	
Conventional	8.51	2.06	65.40	49.3
Hybrid	0.16	0.59	3.39	9.5

XII. DISCUSSION AND CONCLUSION

The results show that the simulated hybrid electric bus components are chosen properly and can support the bus requirements for driving in such a drive cycle. In addition, the results depict a considerable reduction in emission and fuel consumption in the hybrid electric case in compare with the diesel bus. The hybrid vehicle can use a smaller engine than those on conventional vehicles. When extra acceleration

power is needed, it relies on the battery to provide additional force.

The hybrid Diesel Engine can shut off when the car is stopped and run off their electric motor and battery.

The hybrid vehicles often recover braking energy. Electric hybrid motors take the kinetic energy lost in braking and use it to charge the battery.

Hybrids burn less fuel, so they release much less pollution and fewer greenhouse gases. A typical hybrid bus might reduce up to 40% fuel consumption for the same distance compared with a typical bus.

REFERENCES

- [1] K. Yamagushi, S. Moroto, K. Kobayashi, M. Kawamoto, and Y. Miyaishi, "Development of a new hybrid system dual-system", Society of Automotive Engineers (SAE) Journal, Paper No. 960231, Warrendale, PA, 1997.
- [2] M. Ehsani, Y. Gao, S. Gay and A. Emadi, "Modern Electric, Hybrid Electric and full Cell Vehicles", TL221.15.G39 2004, CRC Press USA.
- [3] A. Khanipour, M. Esfahanian, F. Sangtrash, and M.Amiri, "An investigation on effect of drivetrain hybridization in a series electric transit bus", IGEC2 2006-95317, Torino, Italy.
- [4] A. Khanipour, H. Ghomashi, M. Esfahanian and M. Amiri, "The hybrid bus as the green bus", ESDA 2006-192, Ontario, Canada.
- [5] C. M. Jefferson, R. H. Barnard, "Hybrid Vehicle propulsion", Vol 10, 2002.
- [6] C. C. Chan and K. T. Chau, "Modern Electric Vehicle Technology", Oxford University Press, New York 2001.
- [7] Y. Gao, K. M. Rahman, and M. Ehsani, "Parametric design of the drive train of the of an electrically peaking hybrid (ELPH) vehicle", Society of Automotive Engineering (SAE) Journal, Paper No. 970294, Warrendale, PA, 1997.
- [8] H. H. Nikopoulos, and T. Krepec, "Energy consumption study for a hybrid electric vehicle," SAE J. SP-1243, Paper 970198, Feb. 1997.
- [9] W. W. Marr and W. J. Walsh, "Life-cycle cost evaluations of electric/hybrid vehicles," Energy Conversion Management, vol. 33, no. 9, pp. 849-853, 1992.
- [10] K. B. Wipke and M. R. Cuddy, "Using an advanced vehicle simulator (ADVISOR) to guide hybrid vehicle propulsion system development," available at: <http://www.hev.doe.gov>.



A. Khanipour was born in Iran in 1965. He received B.S. degree (1989) and M.S. degree (1991) in Iran. Currently he is completing his PhD in University of Bradford, UK. Since 1991 he worked at the Azad University, Iran as an assistant professor in the department of mechanical engineering. He was also the deputy managing director of the Automotive Plan, Iran from 1994 to 2005. His current research work is in the field of automotive engineering and HEV's. He is the author of several publications in the areas of Hybrid Electric Vehicles.

K. M. Ebrahimi is a Reader in mechanical engineering in the University of Bradford in UK.

W. J. Seale is a Senior Lecturer in automotive and mechanical engineering in the University of Bradford in UK.