

The effect of the Thickness of Electrical sheet on Overvoltage in the Asynchronous Motors Fed by PWM- converters

Belassel Mohand-Tahar

Abstract—This work is devoted to the calculation of the undulatory parameters and the study of the influence thickness of electrical sheet on overvoltage compared to the carcass and between whorls (sections) of the asynchronous motors supplied with PWM converters.

Keywords—Asynchronous Motors,, PWM, Undulatory Process, Undulatory Parameters, Undulatory Voltage, electrical sheet.

I. INTRODUCTION

THE major part of the energy produced in the world is consumed by electric drive systems, which is transformed into mechanical energy by asynchronous motors associated with frequency converters (AM-FC). The modern solution adopted to save energy, when electromechanical converters are in service, is to use control systems. This control is obtained by associating subsystems to sets of electrical converters and motors allowing adjustment of the speed and the torque in a well-defined interval. To optimize the technical and economical performances in the modern systems, the most affective structure for the frequency converters is performed via a DC ring and the output impulses are generated using the PWM technique. At the output of the frequency converters equipped with PWM, a series of rectangular impulses of the same amplitude but different lengths are obtained. The rapid variation of the voltage with time (du/dt) at the front of the rectangular impulsion causes a generation of an undulatory process in the winding. This physical phenomena causes over voltages in the windings of the electrical machines that are harmful for their service life and their reliability. With the evolution of the semi-conductor techniques, this problem becomes an interested subject for research and development.

One of the means of lutes against the overvoltage caused by PMW is the research of resistant constructions to overvoltage.

II. CALCULATION OF THE UNDULATORY PARAMETERS

The calculation of the wavelength constants is the first stage of solving the problem and based on the known equivalent circuit (Fig. 1a):

This work was supported in part by the Mouloud Mammeri University of Tizi-Ouzou, Algeria.

M. T. Belassel is with the Département d'électrotechnique, Faculté de Génie électrique et Informatique, University of Tizi – Ouzou, BP RP17 15000 Algeria, (phone: 00 213 552777250; e-mail: mtbelassel@yahoo.fr, mt_belassel@hotmail.com).

L_s - is the inductance of a section, which takes into account both the self and mutual inductances of an element;

R_s -is the resistance of a section, equivalent to the losses by hysteresis in steel and in the conductors, taking into account the effect of the coating; K_s - is the longitudinal capacitance of the section, i.e. the partial capacitance between the first and the last turn over the length of the winding; C_s - is the transverse capacitance of a section, i.e. partial capacitance of these conductors compared to the carcass, G_s - is the active admittance of the section, equivalent to the dielectric losses in the insulation of the housing.

This calculation method will be applied for tri-phase asynchronous motor with a cage having the following characteristics: Rated power $P_{no}=3$ kW, Input voltage 380/660 AC, number of poles $2p=4$, number of stator slots $Z=36$, their form is oval, a number of turns per section $w=54$. This machine is made of one concentric winding with a single layer at the stator.

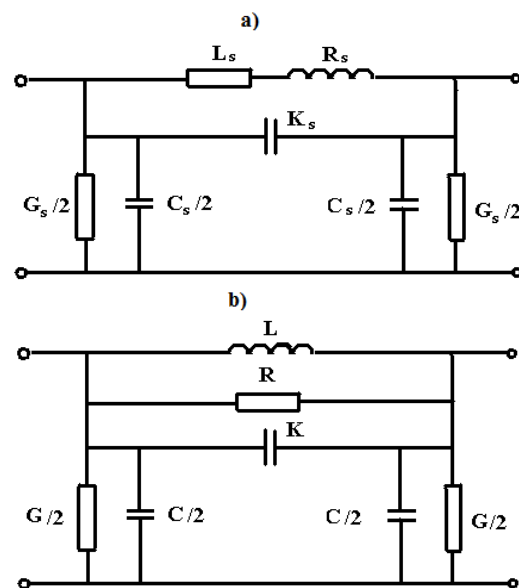

Fig. 1 Equivalent circuit of one winding coil of an IM stator with the series
a) and parallel connection of L_s and R_s

II. CALCULATION OF THE UNDULATORY ELECTRICAL PARAMETERS C_s , K_s AND G_s [3], [5]

Using the method of picture, the calculation of these parameters is carried

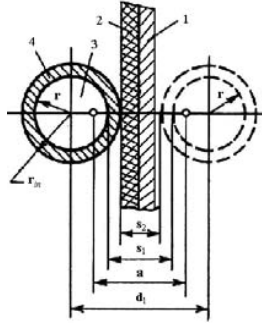

Fig. 2 Determining the capacitance of a conductor relative to the housing:

- 1) slot wall; 2) housing insulation; 3) conductor; 4) turn insulation.

The numbering of conductors in the external layer of the section adjacent to the slot walls may be calculated from formula:

$$n_i = \frac{\Pi_{sl}}{d'} \quad (1)$$

where Π_{sl} – is the circumference of the slot's free area; d' – is the distance between the centers of adjacent conductors, taking account of the slot-filling coefficient K_f (Fig.1):

$$d' = 2r_{in} \frac{1.075}{\sqrt{k_f}} \quad (2)$$

where r_{in} – is the radius of the insulated conductor in the winding.

To find the capacitance of the conductor relative to the housing, we consider the mirror image of the actual conductor in the slot wall (fig.2), eliminate slot wall 1 and housing insulation 2 from consideration, and replace the image of the conductor by a real conductor. The distance between the winding wire and its image required to calculate the capacitance of this wire is:

$$d_1 = 2 \frac{1.075}{\sqrt{k_f}} (\delta_{sl} + r_{in}) \quad (3)$$

where δ_{sl} – is the thickness of the slot insulation.

The distance between the electrical axes of the real and mirror conductor:

$$a = \sqrt{d_1^2 - 4r^2} \quad (4)$$

where r – is the radius of the conductor without insulation.

Then we can find the distances:

$$s_1 = d_1 - 2r; \quad s_2 = d_1 - 2r_{in} \quad (5)$$

The capacitance of the i -th conductor in the section adjacent to the slot wall is:

$$C_i \approx \frac{2\pi\epsilon_0\epsilon_r\epsilon_{r1}}{\epsilon_r K_1 + (\epsilon_{r1} - \epsilon_r) K_2} \quad (6)$$

where ϵ_r – is the dielectric permittivity of the medium, surrounding the insulated wire, ϵ_{r1} – is the dielectric permittivity of the medium wire insulation; and:

$$K_1 = \ln\left(\frac{a+s_1}{a-s_1}\right); \quad K_2 = \ln\left(\frac{a+s_2}{a-s_2}\right) \quad (7)$$

The dielectric permittivity of the medium, surrounding the

Insulated wire is assumed to be the mean value:

$$\epsilon_r = \frac{\epsilon_{r2} + 1}{2} \quad (8)$$

where ϵ_{r2} – is the dielectric permittivity relative of the lacquer applied; 1 – is the dielectric permittivity of air.

The capacitance of the section compared to the core is:

$$C_s = 2l_{sl}n_i C_i \quad (9)$$

l_{sl} – is the length of the stator slot.

The capacitance between adjacent insulated conductors is found from Eq. (6) as $K_i = C_i/2$, with the replacement of d_i by d' . The longitudinal capacitance of the section, including the frontal regions is:

$$K_s = \frac{K_i}{(w-1)k_{st}} l_l \quad (10)$$

where w – is the number of effective conductor in the slot; l_l – is the length of a single winding turn; $k_{st} \approx 0.08$ – is the static mixed coefficient of the loose wound conductors.

The capacity of a single phase of the stator winding relative to the housing is:

$$C_{ph} = K_2 \frac{Z_l}{6} C_s, \quad (11)$$

where Z_l – is the number of stator slots, $K_2 = 1.06$ for enclosed machines.

The input capacitance is:

$$C_{inp} = \frac{C_{ph}}{2N} \sqrt{\frac{C_s + K_s}{C_s}} \quad (12)$$

where N – is the number of coils in the phase.

Moreover, the input capacity over one phase capacity ratio is:

$$r_c = \frac{C_{inp}}{C_{ph}} \quad (13)$$

The admittance G_s is calculated by the following formula:

$$G_s = 2\pi \cdot f_{\dot{e}q} \cdot C_s \cdot \text{tg} \delta \quad (14)$$

where $\text{tg} \delta$ – is the tangent of the dielectric losses; $f_{\dot{e}q}$ – is the equivalent sinusoidal frequency, calculated as follows:

$$f_{\dot{e}q} = \frac{1}{2 \cdot t_f} \quad (15)$$

t_f – the duration of the pulse edge.

II. COMPUTATION OF THE UNDULATORY MAGNETIC PARAMETERS [2], [5]

The majority of the asynchronous cage motors are built with windings using flexible sections and round conductors. In these motors, the conductors of the windings in the slots are randomly distributed. This leads to a great difficulty to calculate the undulatory magnetic parameters. To develop a calculation method, certain assumption considered in this study are reported in [1] and [2] and the oval shape of the slot is replaced by an equivalent circular shape using the conform transformation method (fig.3)

One seeks the inductance of one turn such that:

$$\underline{L}_{tu} = \underline{L}_{iro} + \underline{L}_{con} + \underline{L}_{in} ; L_{tu} = \text{Re}(L_{iro} + L_{con} + L_{in}) \quad (16)$$

where L_{iro} , L_{con} and L_{in} – are the total inductance determined by self magnetic field in the iron, in the conductor and in the insulation of the slots respectively.

The inductance L_{iro} – is calculated as follows:

$$\underline{L}_{iro} = \text{Re} \frac{1}{\underline{Z}_{iro}} = \text{Re} \frac{2 \cdot \mu_0 \cdot l_1}{\frac{1}{\mu_{rsh}} \left(\sum_{i=1}^n \frac{l_i}{a_i} + \frac{2\delta_{air}}{k_{air} a_{air}} \right)} \quad (17)$$

where Z_{iro} – is the total magnetic impedance for the flux embedded in the iron around the slots.

where μ_{rsh} – Relative magnetic permeability of the laminated package of sheet; it is:

$$\underline{\mu}_{rsh} = \frac{1}{\underline{\Gamma}_{iro} (b_1 + b_2)} \mu_0 (\mu_{iro} th \underline{\Gamma}_{iro} b_1 + \underline{\Gamma}_{iro} b_2) \quad (18)$$

and :

$$\underline{\Gamma}_{rsh} = \sqrt{j \cdot \omega \cdot \mu_0 \cdot \mu_r \cdot \sigma_{iro}} \quad (19)$$

a_i and l_i – width and length of the part considered of the magnetic circuit; δ_{air} and a_{air} – air-gap and its width under the teeth of the stator; μ_0 and μ_r – Magnetic permeability of air and steel respectively; σ_{iro} – conductivity of iron; ω – pulsation.

$2b_1$, and $2b_2$ – thickness of the magnetic sheets and the insulation between them respectively.

One determines L_{inc} inductance for the central conductor of the equivalent slot:

$$L_{inc} = \frac{\mu_0 l_{tu}}{2\pi} \ln \frac{R_1}{r_1} \quad (20)$$

The internal inductance of the cylindrical conductor is:

$$L_{con} = \frac{1}{\omega} \text{Im} \left[\frac{k l_{tu}}{\sigma_{co} 2\pi r_1} \frac{J_0(kr_1)}{J_1(kr_1)} \right] \quad (21)$$

where l_{tu} – is the length of one turn of the winding, σ_{co} – is the electrical conductivity of copper, r_1 – is the radius of the conductor without the insulation, $J_0(kr_1)$ et $J_1(kr_1)$ – are the type one Bessel functions of order zero and one respectively.

$$K = \sqrt{-j \cdot \omega \cdot \mu_0 \cdot \sigma_{co}} \quad (22)$$

In this case, the conductors which are apart from the center of the slot in the plane Z (fig.4), must be transferred in the center from the slot on the plane w using the conform transformation utilizing a fractional linear function such as:

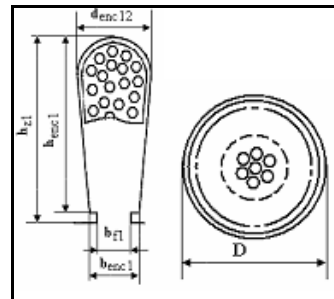

Fig. 3 (a) Semi close oval notch of a asynchronous motor, (b) and its equivalent

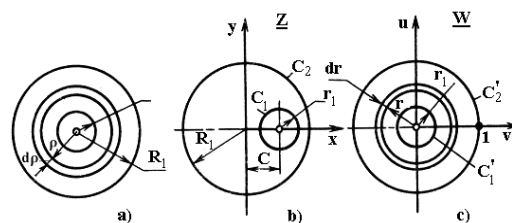

Fig.4. for the calculation of inductance L_{inc}

$$w = \lambda \frac{z - x_1}{z - x_2} \quad (23)$$

where x_1 et x_2 – the X -coordinates of the symmetrical points compared to the circles C_1 and C_2 , they are determined by the following equation

$$cx^2 - (R_1^2 - r_1^2 + c^2)x + cR_1^2 = 0 \quad (24)$$

where c – is the shift of the centers of the circles C_1 and C_2 . as one represents the C_1 circles and C_2 one passes on other circles C'_1 and C'_2 on the plane w . By supposing that the radius of the circle $C'_2 = 1$ (unit radius), the λ term is determined as follows:

$$\lambda = \frac{R_1 - x_2}{R_1 - x_1} \quad (25)$$

moreover, the radius of the circle C'_1 (radius of the conductor) is obtained by the following equation:

$$C'_1 = \frac{(R_1 - x_2)(r_1 + c - x_1)}{(R_1 - x_1)(r_1 + c - x_2)} \quad (26)$$

thus, L_{is} is the inductance for a conductor placed in the center of the slot and which can be determined according to the following equation:

$$L_{in} = \frac{\mu_0 I_{tu}}{2\pi} \ln \frac{C_2'}{C_1'} = \frac{\mu_0 I_{tu}}{2\pi} \ln \frac{(R_1 - x_1)(r_1 + c - x_2)}{(R_1 - x_2)(r_1 + c - x_1)} \quad (27)$$

a. *Mutual inductance of a turn winding*

The value of the mutual inductance of the k-th turn of he winding with respect to the i-th turn is given by:

$$\underline{M}_{ki} = \frac{\dot{\psi}_{ki}}{I_i} \quad (28)$$

where ψ_{ki} – is the total flux of mutual induction of the turn k caused by current I_i in the winding turn i

The total flux ψ_{ki} is determined using the expression:

$$\dot{\psi}_{ki} = \dot{I}_i (\Lambda_{ki} + \underline{\Lambda}_{iro}) \quad (29)$$

where Λ_{ki} – is the Magnetic conductivity for the flux of the mutual inductance of the part of slot; Λ_{fer} – is the magnetic conductivity of the iron that can be determined as follows:

$$\underline{\Lambda}_{iro} = \frac{1}{\underline{Z}_{iro}} \quad (30)$$

for the determination of Λ_{ki} the systems of conductors are modified by the introduction of a conform transformation using the following fractional linear function:

$$\underline{w} = \lambda \frac{\underline{Z} - \underline{Z}_1}{\underline{Z} - \underline{Z}_2} \quad (31)$$

The transformation is performed in such way that the i-th conductor is in the center of the system with a radius $R_1' = 1$. The Z_{1i} et Z_{2i} modules are designated by z_{1i} and z_{2i} and their arguments φ_i . The modules are determined from the equation:

$$c_i z^2 - (R_1^2 - r_1^2 + c_i^2)z + c_i R_1^2 = 0 \quad (32)$$

where c_i – distance between the geometrical centers of the slots and the i-th conductor.

The coefficient λ_i will be equal to:

$$\underline{\lambda}_i = \frac{R_1 - z_{2i}}{R_1 - z_{1i}} e^{j\varphi_i} \quad (33)$$

The position of the k-th conductor in the plane \underline{w} – is determined by the expression:

$$\underline{w}_k = \underline{\lambda}_i \frac{\underline{Z}_k - \underline{Z}_{1i}}{\underline{Z}_k - \underline{Z}_{2i}} \quad (34)$$

In addition, the distance between the center of the system and the center of the k-th conductor is equal to:

$$\rho_k = \text{mod} \left(\lambda_i \frac{\underline{Z}_k - \underline{Z}_{1i}}{\underline{Z}_k - \underline{Z}_{2i}} \right) \quad (35)$$

Moreover, the magnetic conductivity Λ_{ki} – is :

$$\Lambda_{ki} = \frac{\mu_0 I_e}{2\pi} \ln \frac{1}{\rho_k} \quad (36)$$

Subsequently, the mutual inductance M_{ki} – is obtained using the formula:

$$\underline{M}_{ki} = \frac{\mu_0 I_{tu}}{2\pi} \ln \frac{1}{\rho_k} + \frac{2\mu_0 I_1}{\underline{\mu}_{rsh} \left(\sum_{i=1}^n \frac{I_i}{a_i} + \frac{2\delta_e}{k_e a_e} \right)} \quad (37)$$

By using the method of summation, the inductance of the k-th turn could be calculated by the expression:

$$\underline{L}_k = \underline{L}_{tuk} + \sum_{i=1}^n \underline{M}_{ki} \quad (i \neq k), \quad (38)$$

where \underline{L}_{tuk} – is the self-inductance of a single turn, M_{ki} – is the mutual inductance between the k et i turn, n – is the number of conductors in the section.

Parameters of the section

The complex value of the total inductance of the section is equal to:

$$\underline{L}_t = \frac{1}{m_i} \sum_{k=1}^w \underline{L}_k \quad (39)$$

where m_i – is the number of the parallel conductors, w is the number of turns in the section.

By multiplying \underline{L}_t by $j\omega_{eq}$, we obtain the total resistance of the section, determined using its magnetic field:

$$\underline{Z}_s = j\omega_{eq} \underline{L}_t = R_{iro} + j\omega_{eq} L_s \quad (40)$$

where R_{iro} – is the active resistance of the section, equivalent to eddy current losses in the iron, L_s – inductance of the section.

with:

$$R_{iro} = \text{Re } \underline{Z}_s, \quad L_s = \text{Re } \underline{L}_t \quad (41)$$

The total active resistance of the section is determined using the following expression:

$$R_s = R_{iro} + R_{con} \quad (42)$$

where R_{con} – is the active resistance of the section equivalent to eddy current losses in the conductors. This can be calculated using the following formula:

$$R_{con} = \frac{w}{m_i} \text{Re} \left[\frac{k l_{sp}}{\sigma_m 2\pi r_1} \frac{J_0(kr_1)}{J_1(kr_1)} \right] \quad (43)$$

Remember that the value of R_{con} – is much smaller than R_s , and therefore it is possible to be neglected in the calculations, therefore:

$$R_s \approx R = \text{Re } \underline{Z}_s \quad (44)$$

In addition, the longitudinal resistance of the section according to the equivalent diagram, (fig.1) and while taking into account the longitudinal capacity K_s will be written as follows:

$$\underline{Z}_s = \frac{R_s + j\omega_{eq} L_s}{1 + j\omega_{eq} K_s (R_s + j\omega_{eq} L_s)} \quad (45)$$

In this manner one can determine the longitudinal parameters of this bipolar:

$$L = \frac{1}{\omega_{eq}} \operatorname{Im} \frac{Z_s}{1 - j \cdot \omega_{eq} \cdot K_s \cdot Z_s}; \quad R = \operatorname{Re} \frac{Z_s}{1 - j \cdot \omega_{eq} \cdot K_s \cdot Z_s} \quad (46)$$

IV. DETERMINATION OF THE UNDULATORY VOLTAGES

Analytic calculation of the voltage surges in the IM winding [1-3] and [6] entails the solution of the differential equation of the wave process (WP), which is written for the equivalent circuit in Fig. 1b).

The relation between the parameters of the two diagrams Fig.1 a) and b) is given:

$$L = L_s + \frac{R_s^2}{\omega^2 L_s}; \quad R = R_s + \frac{(\omega L_s)^2}{R_s} \quad (47)$$

The voltage distribution in the given circuit is described by a hyperbolic partial differential equation [1-7]:

$$K \frac{\partial^4 u(x,t)}{\partial x^2 \partial t^2} + \frac{1}{R} \cdot \frac{\partial^3 u(x,t)}{\partial x^2 \partial t} + \frac{1}{L} \cdot \frac{\partial^2 u(x,t)}{\partial x^2} - C \frac{\partial^2 u(x,t)}{\partial t^2} - G \frac{\partial u(x,t)}{\partial t} = 0 \quad (48)$$

Here the x-coordinates vary continuously in the range $0 \leq x \leq l$; l – is the length of the conductors in the parallel branch of the phase winding. Variation in x in the opposite direction to the incident wave motion, i.e., from the end of the winding ($x = 0$) to its beginning ($x=l$), is assumed to be positive.

All the parameters in the equation are referred to unit length. Therefore, the dimensions of the parameters are as follows:

- for the longitudinal branch:
 - the inductance $[L]=\text{H/m}$;
 - the resistance $[R] = \text{Ohm/m}$;
 - the longitudinal capacitance $[K]=\text{F}\cdot\text{m}$.
- for the transverse branch:
 - the transversal capacitance $[C] = \text{F/m}$;
 - the conductivity $[G] = 1 / \text{Ohm}\cdot\text{m}$.

The equation is solved by the Fourier method. To this end, the initial and boundary conditions determining the physical characteristics of the phenomena in the winding are preliminary specified. They are formulated as follows: a voltage wave characterized by the following equation is incident at the winding.

$$u_{pul} = U(e^{-\alpha t} - e^{-\beta t}) \quad \text{when } t > 0 \quad (49)$$

where $U = 10$ (V) – is the pulse amplitude; α and β – are constants: $\alpha = 1.2 \cdot 10^6$ (sec^{-1}) $\beta = 2 \cdot 10^6$ (sec^{-1}).

Zero initial conditions are assumed. The state is characterized by the following equation:

$$\frac{\partial^3 (u,0)}{\partial^2 x \partial t} = \gamma^2 \frac{\partial u(x,0)}{\partial t} \quad (50)$$

where $\gamma = \sqrt{C/K}$

The ends of the winding are insulated, with following boundary conditions:

- for the ends of the winding ($x=l$); $U(l,t) = u_{pul}(t)$
- for the ends of the winding ($x=0$).

$$\frac{\partial u(0,t)}{\partial x} = 0 \quad (51)$$

Note that, by solving the equation by the Fourier method, the frequency dependence of R , L and G is taken into account iteratively [1], [2], [3] and [6].

VI. COMPUTATION RESULTS OF THE UNDULATORY PARAMETERS AND OVERPRESSURES

Computation results of the parameters C_s and K_s without considering their variation according to the frequency and G_s , L_s , R_s for a frequency of 200 kHz and for various values thickness of electrical sheet δ_{iro} , are given on table 1.

TABLE.1
NUMERICAL VALUES FOR THE UNDULATORY PARAMETERS

parameters	Thickness of electrical sheet		
	$\delta_{iro}=0.28, \text{mm}$	$\delta_{iro}=0.5, \text{mm}$	$\delta_{iro}=1, \text{mm}$
C_s, pF	1085	1085	1085
K_s, pF	10,44	10,44	10,44
$G_s, 1/\Omega$	$3,25 \cdot 10^{-5}$	$3,25 \cdot 10^{-5}$	$3,25 \cdot 10^{-5}$
R_s, Ω	235,59	173,92	108,49
$L_s, \mu\text{H}$	2000	1250	662

The computational results of the undulatory voltage, assuming that the windings is supplied with a similar impulsion as for an impulsion generated by a PWM control equipped with IGBT transistors are shown in figures 5, 6, and 7, for various values thickness of electrical sheet δ_{iro} . Figure 5, represents the undulatory process on the neutral of winding, Figure 6, gives WP on the first and the last section of a winding and Fig.7.presents the voltage distribution for every six turns along the parallel path for two points in times: $t=3 \cdot 10^{-7}$ s and $t=1,2 \cdot 10^{-6}$.

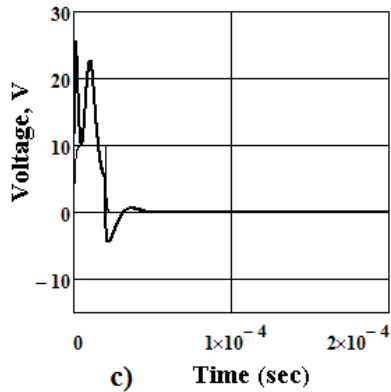
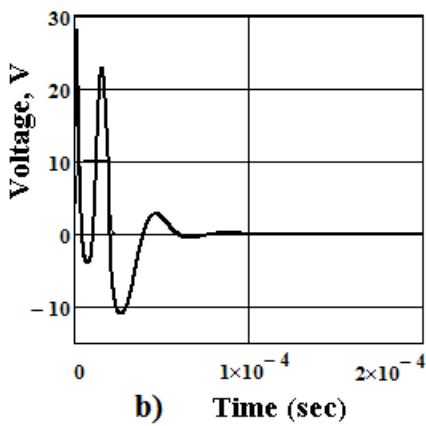
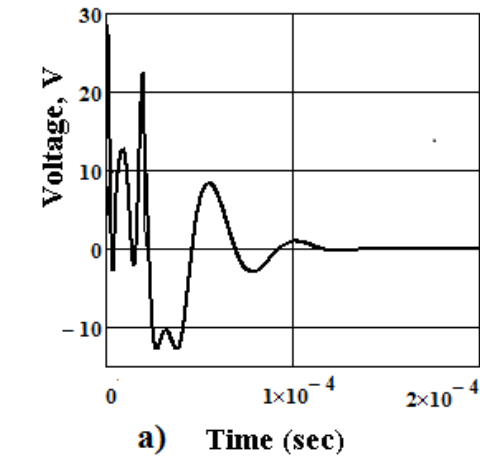

Fig.5. Wave process in the winding phase of the motor:

— Applied impulse on the phase
 — Voltage in the extremity of the phase

a) $\delta_{iro}=0.28(\text{mm})$; b) $\delta_{iro}=0.5(\text{mm})$; c) $\delta_{iro}=1(\text{mm})$;

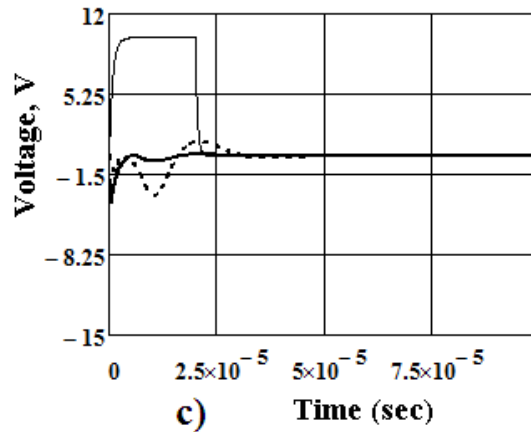
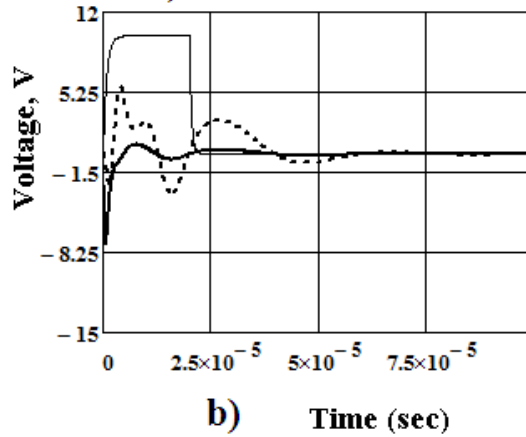
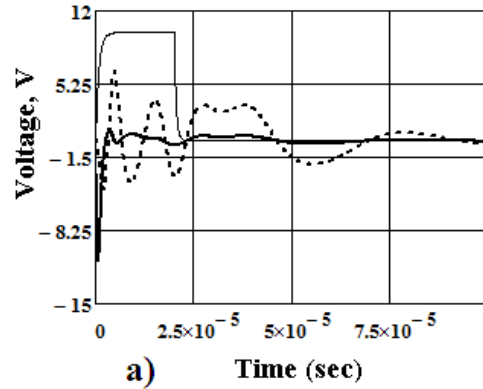

Fig.6. Wave process in the winding phase of the motor:

— Applied impulse on the phase
 — Tension on the first section of the winding
 Tension on the last section of the winding

a) $\delta_{iro}=0.28(\text{mm})$; b) $\delta_{iro}=0.5(\text{mm})$; c) $\delta_{iro}=1(\text{mm})$;

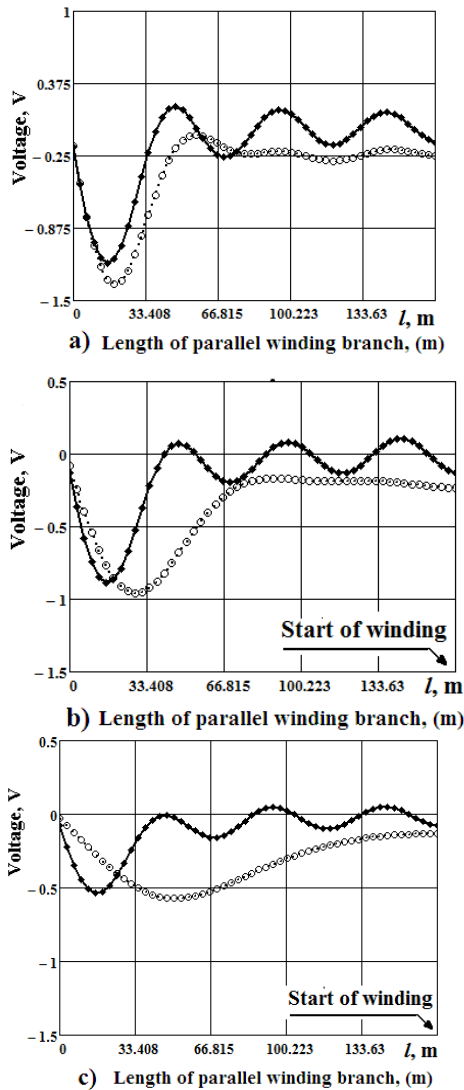

Fig.7 Distribution of voltage through every six turns along the parallel paths of a winding for two points in times:

↔ $t=3.10^{-7}$ s, ○-○-○ $t= 1,2.10^{-6}$ s

a) $\delta_{iro}=0.28$ (mm); b) $\delta_{iro}=0.5$ (mm); c) $\delta_{iro}=1$ (mm);

V. CONCLUSION

1. The arrival of a rectangular impulsional voltage similar to the one of a PWM variable frequency control in an asynchronous motor winding will trigger in the winding an undulatory process. By treating several cases, one notices that the overvoltages calculated with this method exceeds twice the voltage applied initially and the process at any point of the winding has a deadened oscillatory character (figure 5 a), b) and c))
2. The results of simulation obtained show that overvoltage decrease considerably with the increase thickness of electrical sheets (figures 6 and 7).
3. It can be seen from Fig.6 that the voltage distribution at the section along the parallel path at the different points in time becomes more uniform with the increase in the time of the undulatory process.
4. The presented calculation procedure for wave-length constants and overvoltage's in the pulls supply broadens the possibilities of investigation and the design of an insulation system for variable-speed drives and allows the choice for much correct values for interturn test voltages.

REFERENCES

- [1] M.T Belassel and V.YA Bepalov. «High-frequency parameters and voltage surges between the whorls of flexible winding to several winding of induction motors, fed by PMW»
- [2] M.T Belassel, V.YA Bepalov. «High-frequency parameters and voltage surges in different types windings of induction motors fed by PWM » Electrotekhnika., no. 7, p. 14-17, 2008
- [3] M.T Belassel, Bepalov V.YA., Chetate Boukhemis. «Capacitive parameters and voltage surges in the winding of an asynchronous motor with power supply from a PWM- converter» Electrotekhnika. no .1, P. 44-48, 2005.
- [4] M.T. BELASSEL. « Calculation of over voltages in the Asynchronous Motors Supplied with Frequency converters of the type Modulation of Impulsion Breadth (PWM) » 16 th International Conference on the Computation of Electromagnetic Fields «Compumag 2007» June 24-28, 2007 Aachen, Germany.
- [5] Boukhemis Chetate, Mohand-Tahar Belassel, Stéphane Simard, Rachid Beguenane, « Influence of Overvoltages in Induction Motors fed by PWM voltage inverters on Power efficiency», Electrical Power Conference, 2007. EPC 2007. IEEE Canada Number: 10052327), pages 399-404.
- [6] Kaganov Z.G. Electrical circuit with distributed parameters and chain circuits. Energoatomizdat. Moscow, 1990.
- [7] Vataev A.C. High frequency electromagnetic process and overvoltages in the squirrel cage induction motors, supplied with the frequency converters. PHD, Saint Petersburg, 2009, Russia.