

# Noise Analysis of Single-Ended Input Differential Amplifier using Stochastic Differential Equation

Tarun Kumar Rawat, Abhirup Lahiri, and Ashish Gupta

**Abstract**—In this paper, we analyze the effect of noise in a single-ended input differential amplifier working at high frequencies. Both extrinsic and intrinsic noise are analyzed using time domain method employing techniques from stochastic calculus. Stochastic differential equations are used to obtain autocorrelation functions of the output noise voltage and other solution statistics like mean and variance. The analysis leads to important design implications and suggests changes in the device parameters for improved noise characteristics of the differential amplifier.

**Keywords**—Single-ended input differential amplifier, Noise, stochastic differential equation, mean and variance.

## I. INTRODUCTION

The differential pair or differential amplifier configuration is the most widely used building block in analog integrated-circuit design. For instance, the input stage of every operational-amplifier is a differential amplifier. Double-ended input differential amplifiers are much less sensitive to noise and interference than single-ended differential amplifiers. Thus, noise is a significant problem in single ended differential amplifiers which play a key role in hard disk drive (HDD) applications. A single-ended differential input amplifier is used as the initial amplification stage of a preamplifier used in the read channel of a HDD application [1]. In hard disk drives, a magnetic read head moves over a portion of the hard disk when reading data. A preamplifier, having an initial amplification stage of the single-ended type, connects to the magnetic read head and amplifies a data signal picked up by the magnetic read head. Therefore, there is a need of single-ended differential input amplifier with improved noise characteristics.

In this paper, we shall concentrate on the noise analysis of a single-ended differential amplifier. We analyze the effect of the noise signal on the output voltage. Noise can enter the circuit via various paths - the noise from within the amplifier (intrinsic) and the noise signal which is fed externally from a read head (extrinsic). This extrinsic noise enters into the read channels of the preamplifier from the substrate capacitances of the input transistors connected to the read heads [1].

Circuit noise analysis is traditionally done in frequency domain. The approach is effective in cases where the circuit

is linear and time invariant. But the approach is not applicable for the extrinsic noise because the system may not be either linear or time invariant due to the switching nature of the signal picked [2]. Before going any further, it should be clearly understood that intrinsic noise being random is common to both the inputs and therefore the corresponding differential output voltage is zero provided the transistors are well matched. The circuit amplifies the external noise signals picked up from the magnetic read head (which basically acts as a differential input fed in a single-ended fashion), yet it rejects the intrinsic noise signals which are common to both the inputs. Therefore, analysis for the intrinsic noise is not of much use and in this paper we do rigorous analysis of extrinsic noise for the topology wherein the differential amplifier is not fed in the complimentary fashion, rather, the input is applied to one of the input terminals while the other terminal is grounded (Fig.1).

For the stochastic model being used in the paper, the external noise is assumed to be a white Gaussian noise process. Although the assumption of a white Gaussian noise is an idealization, it may be justified because of the existence of many random input effects. According to the Central Limit Theorem, when the uncertainty is due to additive effects of many random factors, the probability distribution of such random variables is Gaussian. It may be difficult to isolate and model each factor that produces uncertainty in the circuit analysis. Therefore, the noise sources are assumed to be white with a flat power spectral density (PSD).

In this method, we shall follow a time domain approach based on solving a SDE. The method of SDEs in circuit noise analysis was used in [3] from a circuit simulation point of view. Their approach is based on linearization of SDEs about its simulated deterministic trajectory. In this paper we will use a different approach from which analytical solution to the SDE will be obtained. The analytical solution will take into account the circuit time varying nature and it will be shown that the noise becomes significant at high input signal frequencies. The main aim of our analysis is to observe the effect of noise present in the input signal on the output of the differential amplifier and find out the frequencies at or above which the noise becomes significant.

The rest of the paper is organized as follows. Section II derives the differential equations governing noise variance processes and solves them in time domain. In Section III, we use state variable method to do the same which essentially combines all the equations into one state equation which can be solved to get the desired solution statistics. Section IV provides with the simulation results and design implications

Tarun Kumar Rawat is with the Division of Electronics and Communication Engineering, Netaji Subhas Institute of Technology, Dwarka, Sector 3, New Delhi-110075, India, email: tarundsp@gmail.com

Abhirup Lahiri is with the Division of Electronics and Communication Engineering, Netaji Subhas Institute of Technology, Dwarka, Sector 3, New Delhi-110075, India, email: abhiruplahiri@yahoo.com

Ashish Gupta is with the Division of Electronics and Communication Engineering, Netaji Subhas Institute of Technology, Dwarka, Sector 3, New Delhi-110075, India, email:ashishgupta1987@gmail.com

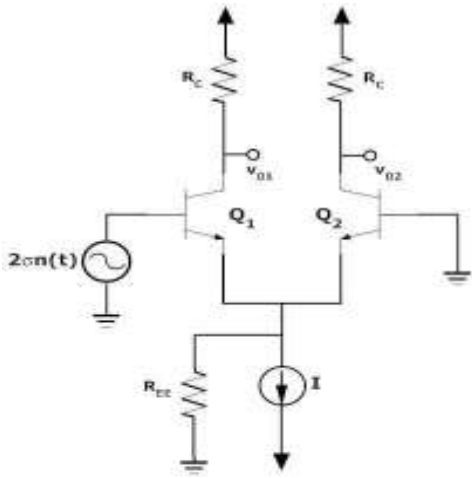

Fig. 1. Differential amplifier with one end grounded

followed by the conclusions in Section V.

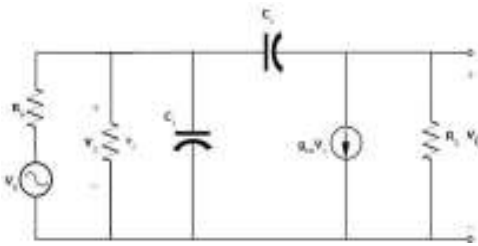

Fig. 2. High-frequency equivalent half-circuit

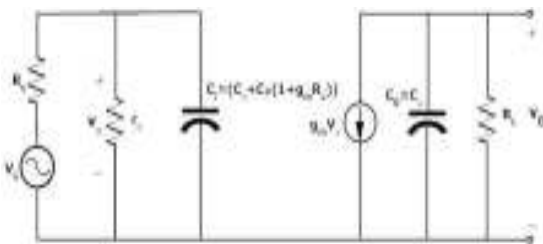

Fig. 3. Simplified high-frequency equivalent half-circuit

## II. ANALYSIS OF NOISE VIA SDEs

Consider a differential amplifier with one end grounded and the other end provided with the input signal (Fig. 1) whose high-frequency equivalent half-circuit is depicted in Fig.2. Henceforth, we analyze the system using SDEs. A very important assumption used during the analysis is that the two transistors Q1 and Q2 have been considered to be

perfectly matched. Simplifying the circuit in Fig. 2 using Miller's Theorem, we obtain Fig. 3 for which,

$$\frac{v_s(t) - v_\pi(t)}{R_s} = \frac{v_\pi(t)}{r_\pi} + C_i \frac{dv_\pi(t)}{dt} \quad (1)$$

where  $C_i$  represents the input capacitance  $C_i = C_\pi + C_\mu(1 + g_m R_L)$  and

$$C_0 \frac{dv_0(t)}{dt} + \frac{v_0(t)}{R_L} = -g_m v_\pi(t) \quad (2)$$

where  $C_0 \approx C_\mu$ . Using some straightforward simplifications, (1) can be written as

$$\frac{dv_\pi(t)}{dt} + k_1 v_\pi(t) = \frac{v_s(t)}{R_s C_i} \quad (3)$$

where  $k_1 = \frac{1}{C_i}(\frac{1}{r_\pi} + \frac{1}{R_s})$ . Considering  $v_s(t) = n(t)$ , where  $n(t)$  represents Gaussian white noise process and  $n^2$  is the magnitude of PSD of input noise process. Substituting  $v_s(t) = n(t)$  in (3), we obtain

$$\frac{dv_\pi(t)}{dt} + k_1 v_\pi(t) = \frac{n(t)}{R_s C_i} \quad (4)$$

First, we multiply both sides of (4) with  $dt$ , then take expectation both sides. Since the continuous-time white noise process is a generalized function, the solution is rewritten by the replacement  $n(t)dt = dW(t)$ , where  $W(t)$  is the Wiener motion process, a continuous, but not differentiable process [4].

$$dE[v_\pi(t)] + k_1 E[v_\pi(t)]dt = \frac{E[W(t)]}{R_s C_i} \quad (5)$$

Using the fact that  $E[dW(t)] = 0$ , (5) results in the following:

$$\frac{E[v_\pi(t)]}{dt} + k_1 E[v_\pi(t)] = 0 \quad (6)$$

The above equation describes the mean of the output process, which happens to be exactly the same as the differential equation for the system without noise. The solution of (6) is found out to be

$$E[v_\pi(t)] = c_1 e^{-k_1 t} \quad (7)$$

where  $c_1$  is a constant whose value depends on the initial circuit conditions. Next, we consider (2) because one of our main purposes is to find the mean of the output due to input noise signal. Simplifying and taking expectation on both sides of (2) we get the following equation for the mean of output

$$\frac{dE[v_0(t)]}{dt} + \frac{E[v_0(t)]}{R_L C_0} = \frac{-g_m}{C_0} E[v_\pi(t)] \quad (8)$$

the solution to which is

$$E[v_0(t)]e^{k_2 t} = \frac{-g_m c_1}{C_0} \int e^{(k_2 - k_1)t} dt \quad (9)$$

where  $k_2 = \frac{1}{R_L C_0}$ . On solving (9) we get

$$E[v_0(t)]e^{k_2 t} = \frac{c_2}{(k_2 - k_1)} e^{(k_2 - k_1)t} + c_3 \quad (10)$$

where  $c_2 = \frac{-g_m c_1}{C_0}$  and  $c_3$  is constant of integration whose value depends on initial conditions provided. It is evident for

initial conditions of  $v_0(0) = 0$  and  $v_\pi(0) = 0$  that mean of output voltage is zero.

Next we find the autocorrelation function which will lead us to finding the variance. For pedagogical reasons, the autocorrelation function is obtained considering initial conditions of  $v_0(0) = 0$  and  $v_\pi(0) = 0$ . Rewriting equations (2) and (3) with some straightforward simplifications, we obtain

$$\frac{dv_0(t)}{dt} + \frac{v_0(t)}{R_L C_0} = \frac{-g_m v_\pi(t)}{C_0} \quad (11)$$

$$\frac{dv_\pi(t)}{dt} + k_1 v_\pi(t) = \frac{v_s(t)}{R_s C_i} \quad (12)$$

Next, we consider (11) at time  $t = t_2$  with initial conditions  $R_{v_0, v_0}(t_1, 0) = E[v_0(t_1)v_0(t_2)]|_{t_2=0} = 0$ . Multiplying both sides of (11) with  $v_0(t_1)$  and then taking the expectation, we obtain

$$\frac{dR_{v_0, v_0}(t_1, t_2)}{dt_2} + \frac{R_{v_0, v_0}(t_1, t_2)}{C_0 R_L} = \frac{-g_m R_{v_0, v_\pi}(t_1, t_2)}{C_0} \quad (13)$$

Again consider (11) at  $t = t_1$  and with initial conditions  $R_{v_0, v_\pi}(0, t_2) = E[v_0(t_1)v_\pi(t_2)]|_{t_1=0} = 0$ . Multiplying both sides of (11) with  $v_\pi(t_2)$  and taking the expectation, we obtain

$$\frac{dR_{v_0, v_\pi}(t_1, t_2)}{dt_1} + \frac{R_{v_0, v_\pi}(t_1, t_2)}{C_0 R_L} = \frac{-g_m R_{v_0, v_\pi}(t_1, t_2)}{C_0} \quad (14)$$

Next, we consider (12) at  $t = t_1$  and with initial conditions  $R_{v_\pi, v_\pi}(0, t_2) = E[v_\pi(t_1)v_\pi(t_2)]|_{t_1=0} = 0$ . Multiplying both sides of (12) with  $v_\pi(t_2)$  and then taking the expectation, we obtain

$$\frac{dR_{v_\pi, v_\pi}(t_1, t_2)}{dt_1} + k_1 R_{v_\pi, v_\pi}(t_1, t_2) = \frac{R_{v_s, v_s}(t_1, t_2)}{R_s C_i} \quad (15)$$

Again consider (12) at  $t = t_2$  and with initial conditions  $R_{v_s, v_\pi}(t_1, 0) = E[v_s(t_1)v_\pi(t_2)]|_{t_2=0} = 0$ . Multiplying both sides of (12) with  $v_s(t_1)$  and taking the expectation, we obtain

$$\frac{dR_{v_s, v_\pi}(t_1, t_2)}{dt_2} + k_1 R_{v_s, v_\pi}(t_1, t_2) = \frac{R_{v_s, v_s}(t_1, t_2)}{R_s C_i} \quad (16)$$

We need to solve the differential equations (13), (14), (15) and (16) to find out the value of  $R_{v_0, v_0}(t_1, t_2)$ . Knowing that  $R_{v_s, v_s}(t_1, t_2) = \delta(t_1 - t_2)$ , we find the solution of (16) as

$$R_{v_s, v_\pi}(t_1, t_2) = \frac{2}{R_s C_i} e^{k_1(t_1 - t_2)} \quad (17)$$

Substituting the value of  $R_{v_s, v_\pi}(t_1, t_2)$  from (17) in (15) and taking limit of  $t_1$  from 0 to  $\min(t_1, t_2)$ , we obtain the solution of (15) as

$$R_{v_\pi, v_\pi}(t_1, t_2) = \frac{2}{2k_1(R_s C_i)^2} \left( e^{-k_1(t_1 - t_2)} - e^{-k_1(t_1 + t_2)} \right) \quad (18)$$

Substituting the value of  $R_{v_\pi, v_\pi}(t_1, t_2)$  from (18) in (14) and

taking limit of  $t_1$  from 0 to  $\min(t_1, t_2)$ , we obtain the solution of (14) as

$$R_{v_0, v_\pi}(t_1, t_2) = \frac{k_3}{\frac{1}{R_L} - k_1 C_0} \left( e^{\frac{t_2 - t_1}{C_0 R_L}} - e^{(k_1 t_2 - \frac{t_1}{C_0 R_L})} - e^{(-2k_1 t_2 + \frac{t_2 - t_1}{C_0 R_L})} + e^{(-k_1 t_2 - \frac{t_1}{C_0 R_L})} \right) \quad (19)$$

where  $k_3 = \frac{-g_m \sigma^2}{2k_1(R_s C_i)^2}$ . We now substitute the value of  $R_{v_0, v_\pi}(t_1, t_2)$  from (19) in (13) and obtain the autocorrelation function as follows,

$$R_{v_0, v_0}(t_1, t_2) = \frac{-g_m k_3}{\frac{1}{R_L} - k_1 C_0} \left( \left( e^{\frac{t_2 - t_1}{R_L C_0}} - e^{\frac{-t_1 - t_2}{R_L C_0}} \right) \frac{R_L C_0}{2} + \frac{\left( e^{-2k_1 t_2 + \frac{t_2}{C_0 R_L} - \frac{t_1}{C_0 R_L}} - 2e^{k_1 t_2 - \frac{t_1}{C_0 R_L}} + e^{\frac{-t_1 - t_2}{C_0 R_L}} \right)}{2 \left( k_1 + \frac{1}{C_0 R_L} \right)} - \frac{\left( e^{-k_1 t_2 - \frac{t_1}{C_0 R_L}} - e^{\frac{-t_1 - t_2}{C_0 R_L}} \right)}{\frac{1}{C_0 R_L} - k_1} \right) \quad (20)$$

For  $t_1 = t_2 = t$  in (20) we obtain the second moment of output voltage as  $E[v_0^2(t)]$  (which is variance in this case),

$$E[v_0^2(t)] = \frac{-g_m k_3}{\frac{1}{R_L} - k_1 C_0} \left( \left( 1 - e^{\frac{-2t}{R_L C_0}} \right) \frac{R_L C_0}{2} + \frac{\left( e^{-2k_1 t} - 2e^{(k_1 - \frac{1}{C_0 R_L})t} + e^{\frac{-2t}{C_0 R_L}} \right)}{2 \left( k_1 + \frac{1}{C_0 R_L} \right)} - \frac{\left( e^{(-k_1 - \frac{1}{C_0 R_L})t} - e^{\frac{-2t}{C_0 R_L}} \right)}{\frac{1}{C_0 R_L} - k_1} \right) \quad (21)$$

### III. STATE VARIABLE APPROACH

The resulting equations for the solution statistics can also be derived by using a very similar time domain technique which essentially clubs the dynamics of the variables  $v_0$  and  $v_\pi$ , (which determine the state of the system) into a single state equation. The technique is useful as it helps in finding not only the first two moments but also the cross-correlation of a state variable with the other state of the circuit. The state equation obtained from (2) and (3) is,

$$\frac{d}{dt} \begin{pmatrix} v_0(t) \\ v_\pi(t) \end{pmatrix} = \begin{pmatrix} \frac{-1}{C_0 R_L} & \frac{-g_m}{C_0} \\ 0 & -k_1 \end{pmatrix} \begin{pmatrix} v_0(t) \\ v_\pi(t) \end{pmatrix} + \begin{pmatrix} 0 \\ \frac{1}{R_s C_i} \end{pmatrix} v_s(t) \quad (22)$$

As it can be observed that (22) is of the form

$$\frac{d\mathbf{X}(t)}{dt} = \mathbf{A}\mathbf{X}(t) + \mathbf{B}v_s(t) \quad (23)$$

where

$$\mathbf{X}(t) = \begin{pmatrix} v_0(t) \\ v_\pi(t) \end{pmatrix}$$

$v_0(t)$  and  $v_\pi(t)$  represent the state variables,

$$\mathbf{A} = \begin{pmatrix} \frac{-1}{C_0 R_L} & \frac{-g_m}{C_0} \\ 0 & -k_1 \end{pmatrix}$$

$$\mathbf{B} = \begin{pmatrix} 0 \\ \frac{1}{R_s C_i} \end{pmatrix}$$

Substituting  $v_s(t) = n(t)$  in (23), we get

$$\frac{d\mathbf{X}(t)}{dt} = \mathbf{A}\mathbf{X}(t) + \mathbf{B} n(t) \quad (24)$$

To get a stochastic differential equation we first multiply the above equation by  $dt$  and then replace  $n(t)dt$  by  $dW(t)$ , where  $W(t)$  is a Wiener or Brownian motion process with  $E[dW(t)] = 0$ , and  $E[dW^2(t)] = dt$ .

$$d\mathbf{X}(t) = \mathbf{A}\mathbf{X}(t)dt + \mathbf{B} dW(t) \quad (25)$$

The analytic solution of  $\mathbf{X}(t)$  is given by,

$$\mathbf{X}(t) = e^{\mathbf{A}t} \left( \mathbf{X}(0) + \int_0^t e^{-\mathbf{A}\tau} \mathbf{B} dW(\tau) \right) \quad (26)$$

Next, we consider the statistics of the solution process of  $\mathbf{X}(t)$  of (24). The next result indicates that the first two moments of  $\mathbf{X}(t)$  can be obtained as a solution of initial value problems involving linear ordinary differential equations. It is evident from above that  $E[\mathbf{X}(t)] = e^{\mathbf{A}t} \mathbf{X}(0)$  because expectation of a Brownian process is zero. Also we consider  $\mathbf{M}(t) = E[\mathbf{X}(t)\mathbf{X}^T(t)]$  and assume  $E|\mathbf{X}(0)|^2 < \infty$ . Towards solving  $\mathbf{M}(t)$ , we use product rule for SDEs (appendix A), which in context of (24) becomes

$$d(\mathbf{X}(t)\mathbf{X}^T(t)) = \mathbf{X}(t)d\mathbf{X}^T(t) + (d\mathbf{X}(t))\mathbf{X}^T(t) + \mathbf{B}\mathbf{B}^T dt \quad (27)$$

Substituting  $d\mathbf{X}(t)$  and  $d\mathbf{X}^T(t)$  derived from (25) in (27) we obtain

$$d(\mathbf{X}(t)\mathbf{X}^T(t)) = \mathbf{A}^T \mathbf{X}(t)\mathbf{X}^T(t)dt + \mathbf{X}(t)\mathbf{B}^T dW(t) + \mathbf{A}\mathbf{X}(t)\mathbf{X}^T(t)dt + \mathbf{B}\mathbf{X}^T(t) dW(t) + \mathbf{B}\mathbf{B}^T dt \quad (28)$$

Taking expectation on both sides of (28) and putting  $E[\mathbf{X}(t)\mathbf{X}^T(t)] = \mathbf{M}(t)$  as stated above, we obtain

$$\frac{d\mathbf{M}(t)}{dt} = \mathbf{A}\mathbf{M}(t) + \mathbf{A}^T \mathbf{M}(t) + \mathbf{B}\mathbf{B}^T \quad (29)$$

and  $\mathbf{M}(0) = E[\mathbf{X}(0)\mathbf{X}^T(0)]$ . Substituting the value of  $\mathbf{A}$  and  $\mathbf{B}$  in (29) we get

$$\frac{d\mathbf{M}(t)}{dt} = \begin{pmatrix} \frac{-2}{C_0 R_L} & \frac{-g_m}{C_0} \\ \frac{-g_m}{C_0} & -2k_1 \end{pmatrix} \mathbf{M}(t) + \begin{pmatrix} 0 & 0 \\ 0 & \frac{\sigma^2}{(R_s C_i)^2} \end{pmatrix} \quad (30)$$

which can be solved to get  $\mathbf{M}(t) = E[\mathbf{X}(t)\mathbf{X}^T(t)]$ . Expressions for other solutions statistics, for example, the covariance matrices can be also similarly derived. As it is known that  $E[\mathbf{X}(s)\mathbf{X}^T(t)] = R_{xx}(s, t)$  where  $R_{xx}$  represents the auto-correlation, for the narrow-sense linear equation of the form (24), we get correlation as

$$R_{xx}(s, t) = (s) \left( \mathbf{M}(0) + \int_0^{\min(s,t)} |^{-1}(u)\mathbf{B}|^2 du \right) (t)^T \quad (31)$$

which can be easily solved.

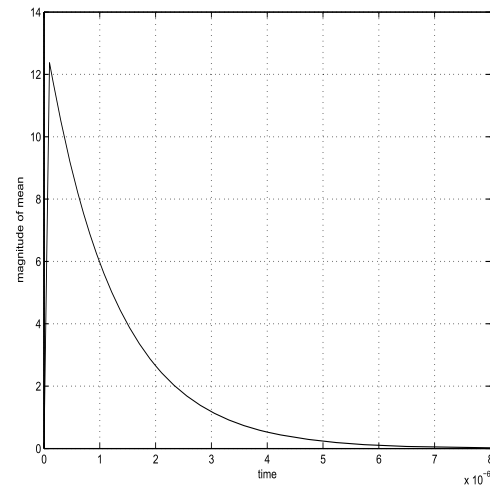

Fig. 4. Variation of mean with time

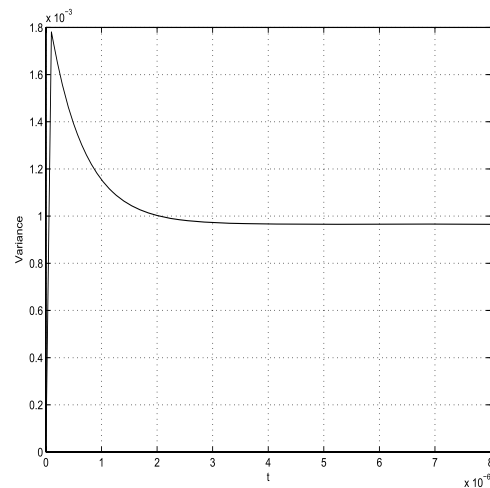
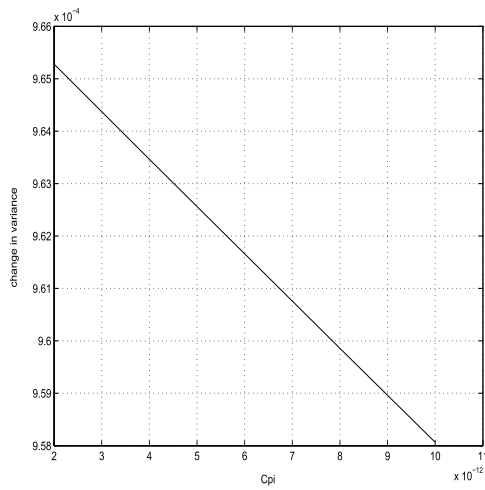
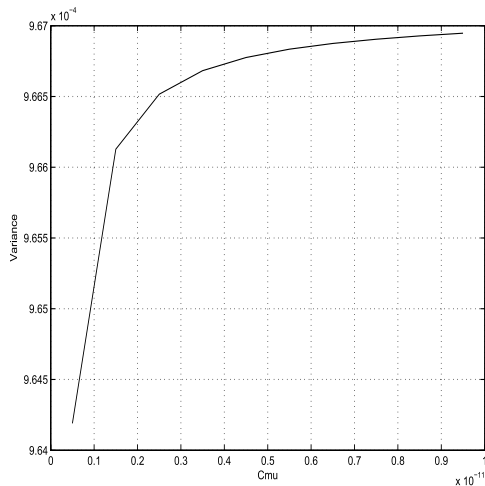

Fig. 5. Variation of variance with time

#### IV. SIMULATION RESULTS AND DESIGN IMPLICATIONS

For the simulation of the results obtained above, we use the following values for the circuit parameters  $R_c = 10^4 \Omega$ ,  $R_s = 5 \times 10^3 \Omega$ ,  $r_\pi = 1.5 \times 10^3 \Omega$ ,  $C_\pi = 2pF$ ,  $C_\mu = 0.8pF$ ,  $V_A = 100V$ ,  $\beta = 200$ . For pedagogical reasons, we consider  $\beta = 0.25$ . Although these values may not be used in the actual application, but they are well chosen for functioning of device within 50 MHz.

Noise in differential amplifiers is analyzed. It should be stressed that although the conclusions are drawn using a very simple and idealized model for differential amplifiers, without

Fig. 6. Effect of device parameter  $C_\pi$ Fig. 7. Effect of device parameter  $C_\mu$ 

taking into many of the other effects (like offset, transistor mismatch etc.). However, we expect this simple approach captures the major effects and may be further extended, which may involve differential equations of higher order.

When initial conditions are nonzero, ( $v_0(0) = 0.01V$  and  $v_\pi(0) = 0.01V$ ), it is observed from the graph of magnitude of first moment of output voltage that initially the magnitude rises to a maximum value of 12.375 volts after which it falls in an exponential fashion (as shown in Fig. 4). It has been calculated that mean reaches its steady state value of zero after a duration of approximately  $7\mu s$ . Although if initial conditions are zero the mean is zero all the time, as stated before. From Fig. 5 it is observed that the variance reaches a constant value of  $9.6528 \times 10^{-3}$  after  $7.4\mu s$ . The maximum value of variance is  $1.8 \times 10^{-3}$ .

This data can be used to guide the design process. The analysis shows that if the input signal frequency is greater than  $142.8kHz$  then the signal time period would be less than the time during which the mean varies. Therefore for the signals of frequencies above 10 MHz (as in the case of HDD application [1]), there would be more than 70 cycles of erroneous results. The fallacy is pertinent and would be more detrimental if the output is taken only for a few starting cycles.

To aid noise reduction, the poles of the single ended amplifier should be matched. This effectively reduces the noise which is common on the inputs to a single ended differential amplifier. Corresponding to this common noise signal, even if the output is taken single endedly it can be made close to zero by increasing the output resistance  $R_{EE}$  of the bias current source. This was regarding the intrinsic noise. For the extrinsic noise, our analysis suggests that the variance can be changed by varying the values of transistor's device parameters. It is evident from Fig. 6 that with increasing values of  $C_\pi$ , variance decreases. Although the variance decreases with the higher value of  $C_\pi$ , but this would result in lowering of the bandwidth. Therefore for the circuit design the value of  $C_\pi$  must be chosen so that noise reduction is achieved without sacrificing much on the bandwidth. On the other hand if a decrease in bandwidth is not acceptable  $C_\pi$  may be maintained constant and the value of  $C_\mu$  can be varied to accomplish the purpose, as a decrease in the value of  $C_\mu$  would not only decrease the variance (Fig. 7) but also increase the bandwidth of the amplifier, which is required in hard disk drives [1] or in any such device which requires the operation on high range of frequencies with low noise. This method is much better than the common industrial practice of increasing emitter resistance thereby providing a negative feedback. Although the signal feedback tends to hold down the amount of noise signal, however, it should be noted that by this there is a reduction in the overall gain of the amplifier. This method suggested although necessitates fabrication of transistors with lower device parameters of  $C_\mu$ , but it does not interfere with the mid band gain of the amplifier.

## V. CONCLUSIONS

Noise in single-ended input differential amplifier is analyzed using stochastic differential equation. Extrinsic noise is characterized by solving a SDE analytically in time domain. The closed form solution for various solution statistics like mean and variance is obtained which can be used for design process. It has been shown that noise becomes significant at high input frequencies. Suitable design methods which involve changing of device parameters are suggested to aid noise reduction and hence design the amplifier with reduced noise characteristics.

## VI. APPENDIX A

### Derivation of $E[X_t^2]$ in the SDE

In this Appendix, we will derive (29). The necessary background is introduced to make this section as self-contained as possible. Thermal noise is often modelled as white noise, whose PSD is flat for all frequencies upto infinity. However, white noise is not a physical process because it has infinite

power. Therefore to treat noise rigorously, we need to define its integral, called Wiener process, which can be approximated by physical processes

$$W(t) = \int_0^t n(s) ds \quad (32)$$

A Wiener process has a continuous sample path and independent Gaussian increments. However, sample paths of a Wiener process have unbounded variation (or infinite length), so it is difficult to find the solution of a Wiener process. Ito's stochastic calculus is invented precisely to solve this problem [6]-[9].

For the general linear case of stochastic differential equation

$$d\mathbf{X}(t) = (\mathbf{f}(t) + \mathbf{F}(t)\mathbf{X}(t)) dt + \sum_{i=1}^m (\mathbf{g}_i(t) + \mathbf{G}_i(t)\mathbf{X}(t)) dW_i(t) \quad (33)$$

where  $\mathbf{X}(t)$  represents a random  $n$  vector process,  $W(t) = [W_1(t), \dots, W_m(t)]^T$  is an  $m$ -vector standard Wiener process,  $\mathbf{F}(t)$  and the  $\mathbf{G}_i(t)$  are  $n \times n$  matrix functions, and  $\mathbf{f}(t)$  and the  $\mathbf{g}_i(t)$  are  $n$  vector functions, respectively [10]. Let  $\Phi(t)$  be the fundamental matrix of the corresponding to (33) homogenous equation

$$d\Phi(t) = \mathbf{F}(t)\Phi(t)dt + \sum_{i=1}^m \mathbf{G}_i(t)\Phi(t)dW_i(t) \quad (34)$$

that is  $\Phi(t)$  is the  $n \times n$  matrix solution of (34) which satisfies  $\Phi(0) = \mathbf{I}$ . The solution of (33) can be written as

$$\mathbf{X}(t) = \Phi(t) \left( \mathbf{X}(0) + \int_0^t \Phi^{-1}(s) \left[ \mathbf{f}(s) - \sum_{i=1}^m \mathbf{G}_i(s)\mathbf{g}_i(s) \right] ds + \int_0^t \Phi^{-1}(s) \sum_{i=1}^m \mathbf{g}_i(s) dW_i(s) \right) \quad (35)$$

In the narrow-sense linear case ( $\mathbf{G}_i(t) = 0$  for all  $i$ , which is exactly the case dealt in this paper), (35) has a simplified form

$$\mathbf{X}(t) = \Phi(t) \left( \mathbf{X}(0) + \int_0^t \Phi^{-1}(s)\mathbf{f}(s) ds + \int_0^t \Phi^{-1}(s) \sum_{i=1}^m \mathbf{g}_i(s) dW_i(s) \right) \quad (36)$$

and the fundamental matrix  $\Phi(t)$  corresponds to the solution of the deterministic initial value problem

$$\frac{d\Phi(t)}{dt} = \mathbf{F}(t)$$

and  $\Phi(0) = \mathbf{I}$  ( $n \times n$  identity matrix), that is,  $\Phi(t)$  is the fundamental matrix for the deterministic part.

In this paper, we have taken the first moment  $\mathbf{m}(t) = E[\mathbf{X}(t)]$  and the second moment  $\mathbf{M}(t) = E[\mathbf{X}(t)\mathbf{X}^T(t)]$ . Towards solving the second moment matrix  $\mathbf{M}(t)$ , recall

that Ito's formula leads to the *product rule* for stochastic differentials, which, in this case takes the form

$$d(\mathbf{X}(t)\mathbf{X}^T(t)) = \mathbf{X}(t)d\mathbf{X}^T(t) + (d\mathbf{X}(t))\mathbf{X}^T(t) + \sum_{i=1}^m (\mathbf{G}_i(t)\mathbf{X}(t) + \mathbf{g}_i(t)) (\mathbf{X}^T(t)\mathbf{G}_i^T(t) + \mathbf{g}_i^T(t)) dt \quad (37)$$

Substituting for  $d\mathbf{X}(t)$  and  $d\mathbf{X}^T(t)$  in (37), writing in integral form, and taking expected value leads to the integral equation equivalent to the initial value problem

$$\begin{aligned} \frac{d\mathbf{M}(t)}{dt} &= \mathbf{F}(t)\mathbf{M}(t) + \mathbf{M}(t)\mathbf{F}^T(t) + \sum_{i=1}^m \mathbf{G}_i(t)\mathbf{M}(t)\mathbf{G}_i^T(t) \\ &+ \mathbf{f}(t)\mathbf{m}^T(t) + \mathbf{m}(t)\mathbf{f}^T(t) + \sum_{i=1}^m (\mathbf{G}_i(t)\mathbf{m}(t)\mathbf{g}_i^T(t) \\ &+ \mathbf{g}_i(t)\mathbf{m}^T(t)\mathbf{G}_i^T(t) + \mathbf{g}_i(t)\mathbf{g}_i^T(t)) \end{aligned} \quad (38)$$

and  $\mathbf{M}(0) = E[\mathbf{X}(0)\mathbf{X}^T(0)]$ .

#### ACKNOWLEDGEMENT

The authors would like to thank Prof. Harish Parthasarthy, who was the catalyst behind their intensive efforts to learn and use probabilistic and stochastic methods.

#### REFERENCES

- [1] Nodar, James (Dallas, Tx, US) *Single ended preamplifiers having improved noise characteristics*, United States patent 20010053036 Texas Instruments Incorporated, <http://www.freepatentsonline.com/20010053036.html>
- [2] Wei Yu and Bosco H. Lueng, *Noise Analysis for Sampling Mixers using Differential Equations*, IEEE Trans. on Circuits and Systems-II: Analog and Digital Signal Processing, Vol. 46, No. 6, June 1999.
- [3] A. Demir, E.W.Y. Liu, and L.S. Vincentelli, *Time Domain Non Monte Carlo Method noise simulation for non linear dynamic circuits with arbitrary excitation*, IEEE Trans. Computer Aided Design, Vol. 15, pp. 493-505, May 1996.
- [4] L. Arnold, *Stochastic Differential Equation*, John Wiley, New York, 1974.
- [5] Adel S. Sedra and Kenneth C. Smith *Microelectronic Circuits*, New York: Oxford University Press, 2003, Ch.-7.
- [6] I Karatzas and S.E. Shreve, *Brownian motion and Stochastic Calculus*, 2nd Edition, New York: Springer-Verlag, 1991.
- [7] Z. Schuss, *Theory and Applications of Stochastic Differential Equations*, New York: Wiley, 1980.
- [8] S.O. Rice *Mathematical Analysis of Random Noise*, Bell sys. tech. J. vols. 23 and 24, Ch 4.6-4.9.
- [9] A. Papoulis *Probability, Random Variables and Stochastic Processes*, New York: McGraw Hill, 1965.
- [10] Thomas C. Gard *Introduction to Stochastic Differential Equations*, New York: Marcel Dekker Inc.