

# Transmission Mains Earthing Design: Under Ground to Over Head Pole Transition

A. Hellany, M. Nassereddine, M. Nagrial, and J. Rizk

**Abstract**—The demand on High voltage (HV) infrastructures is growing due to the corresponding growth in industries and population. New or upgraded HV infrastructure has safety implications since Transmission mains usually occupy the same easement in the vicinity of neighbouring residents. Transmission mains consist of underground (UG) and overhead (OH) sections and the transition between the UG and OH section is known as the UGOH pole. The existence of two transmission mains in the same easement can dictate to resort to more complicated earthing design in order to mitigate the effect of AC interference, and in some cases it can also necessitate completing a Split Study of the system. This paper provides an overview of the AC interference, Split Study and the earthing of an underground feeder including the UGOH pole. In addition, this paper discusses the use of different link boxes on the UG feeder and presents a case study that represent a clear example of the AC interference and Split factor. Finally, a few recommendations are provided to achieve a safety zone in the area beyond the boundary of the HV system.

**Keywords**—UGOH, High Voltage, AC interference, Earthing Design.

## I. INTRODUCTION

THE benefits of electricity are numerous but mishandling it can cause damages to properties and may inflict injuries and fatalities. Electrical management is the key element in human safety, also not underestimating the importance of protection equipment in the wide area of electrical infrastructure can be another added factor in raising the risk factor. Earthing must be the primary concern during the design and operations of electrical infrastructure.

The assumption that any grounded object can be safely touched is not always correct. A serious hazard may result during a ground fault from the transfer of potential between the ground grid area and outside locations. This transferred potential may be transmitted by communication circuits, conductive conduits, pipes, metallic fences, low-voltage neutral wires, etc. The existence of transmission mains can introduce an element of risk that jeopardise the safety of the public and workers in the form of Touch Step voltage, Earth Potential Rise and AC interference. Earthing design is one of the vital keys to overcome the risk factor. The transmission mains can be running in parallel using the same easement, this

Ali Hellany, PhD., is with the University of Western Sydney, Locked Bag 1797 Penrith South DC 1797 NSW Australia (e-mail: a.hellany@uws.edu.au).

M. Nassereddine, NEEC PTY LTD (e-mail: mnassereddine@necgroup.com).

M. Nagrial, Prof. Dr., is with the University of Western Sydney, Locked Bag 1797 Penrith South DC NSW Australia (e-mail: m.nagrial@uws.edu.au).

Jamal Rizk, PhD., is with the University of Western Sydney, Locked Bag 1797 Penrith South DC 1797, NSW Australia (e-mail: j.rizk@uws.edu.au).

will introduce AC interference between the two feeders and require a more rigorous and complicated earthing assessment of this line. Furthermore, the existence of an OH transmission line parallel to an UG section needs to be taken into account when designing and conducting a safety analysis of the UGOH pole.

The existence of the transmission mains underground does not mean that it will not create any unsafe condition. In many situations a fault current can use the screen of a cable as a return path. This paper explores the various elements contributing to the UG line earthing design and introduces a special case where the OH transmission mains are using the same easement for an UG mains running parallel.

## II. SOIL RESISTIVITY

Before the detailed design of the earth grid, it is imperative to study the ground around the site. Soil resistivity plays a fundamental part in determining the earthing grid design. Soil resistivity can be carried out using different methods. It is essential for an efficient earthing design to have more than one test carried out onsite. The most three popular methods to perform soil resistivity test are explained as follows:

### A. Wenner Method

Wenner method consists of four electrodes; two are for current injection and two for potential measurement [1, 2], as shown in Fig. 1.

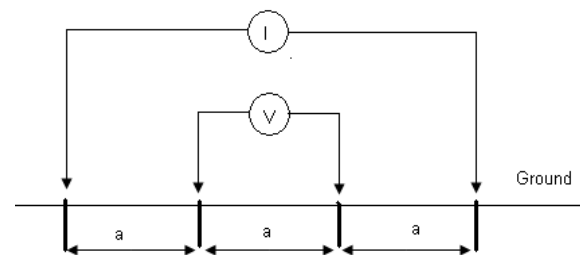

Fig. 1 Wenner four probe arrangement

The soil resistivity formula related to Wenner method is shown in equation 1.

$$\rho = 2\pi aR \quad (1)$$

where

$R$  is the resistance measured by the machine,

$a$  is the spacing of the probe

Wenner array is considered to be the least efficient from labor perception, as it requires four people to perform the task

in a short time. On the other hand it is considered to be the most competent method when it comes to ratio of received voltage per unit of transmitted current [3].

**B. Schlumberger Array**

This method is more economical from man power point of view when compared to Wenner method. The outer electrode can be moved four or five times for each move of the inner electrode [4]. Fig. 2 shows how Schlumberger testing method is conducted. This method can incur an error if the top layer is of high resistivity. Every machine has maximum loop impedance. In certain cases where the soil resistivity of the top layer is very high, it will lead to loop impedance higher than that of the maximum loop impedance of the machine. In this case the reciprocity theorem can be applied to the Schlumberger array and is known as the Inverse Schlumberger Array (ISA). This method provides a safer working environment for the tester under high current supply also reduces the heavier cable needed during the test. The soil resistivity is calculated using equation 2:

$$\rho = \frac{\pi L^2 R}{2l} \tag{2}$$

where:

*L* distance to the centre from the outer probe

*l* distance to the centre from the inner probe

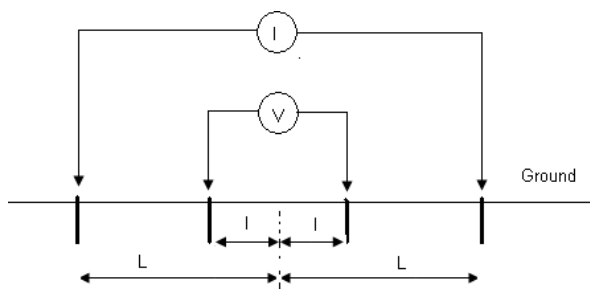

Fig. 2 Schlumberger Array layout

**C. Driven Rod Method**

This method is also known as the three probe method or three pin method [4]. This method is mainly suitable for an area where the physical layout makes it difficult to use either Wenner or Schlumberger methods. Fig. 3 shows the layout of driven rod method. Equation 3 is used to compute the soil resistivity in this method:

$$\rho = \frac{2\pi R}{\ln\left(\frac{8l}{d}\right)} \tag{3}$$

where:

*l* the length of driven rod in contact with earth

*d* driven rod diameter

After completion of the soil resistivity test, and by using software the soil structure is determined. After the agreement on the soil structure, it is possible to compute the grid

resistance or the electrode resistance using one the following formulas. Equation 4 is used to compute the earth grid of a mesh that is buried at a depth of *h*

$$R = \frac{\rho}{\pi L} \left( \ln\left(\frac{4L}{(dh)^{0.5}}\right) - 1 \right) \tag{4}$$

where

*h* is the buried depth

*L* length of the buried conductor

*d* diameter of the earth conductor

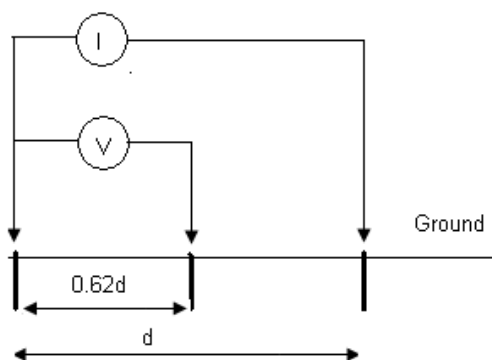

Fig. 3 Driven Rod test layout

**III. SPLIT STUDY AND EPR**

The fault current can be divided into sub-currents:

- Current flow in the earth grid
- Current flow in the auxiliary earthing system

Auxiliary earthing system can be represented by Over Head Earth Wire (OHEW) known as a ground wire, and by the cable sheath of the cable. This auxiliary path acts as a path for partial of the fault current, and reduces the current that flow into the ground. The return current value can be determined after calculating the slip factor. The split factor determines the percentage of the current that flow into the ground the portion that flow into the auxiliary path. [5, 6]

Split factor  $S_f$ , is vital to be determined when designing an earthing system that have an auxiliary path for the fault current. Split factor is essential for determining the actual EPR at the substation and gives an indication of the EPR along the auxiliary path. In addition, it ensures the compliance of any transfer voltage or EPR along the auxiliary path.

The split factor can be determined using equation 5:

$$S_f = 1 - \left( \frac{Z_{gm}}{Z_{gw}} \right) \tag{5}$$

where:

$Z_{gw}$  is the self impedance of the OHEW in  $\Omega/m$ .

$Z_{gm}$  is the mutual impedance per meter between OHEW and phase conductors in  $\Omega/m$ .

The ground current is determined using equation 6:

$$I_g = S_f \times I_f \tag{6}$$

The auxiliary path current is determined using equation 7:

$$I_e = I_f - I_g \tag{7}$$

The auxiliary path current value will assist in assessing the safety of the auxiliary path under any fault at the nominated HV infrastructure. The split factor is used to determine the final impedance of the line as shown in equation 8 [5, 6]:

$$Z_{total} = \frac{S_f R_g}{1 - S_f} \tag{8}$$

#### IV. AC INTERFERENCE

The flow of current in the phase conductor will create an electromagnetic field at 90 degrees of the current vector. The magnetic field will induce a voltage in any metallic object that is parallel to the transmission line. The voltage induced in the metallic object will depend on many variables [7-8]:

- The location of the object, is it underground or above ground
- The separation between the object and the line
- The soil resistivity between the object and the transmission line
- The layout of the transmission line
- The characteristics of the transmission line conductor

Carson's equations [9] can be used to determine the impedance relation between the phase conductor and the metallic object. Fig. 4 shows the layout of 3 phases HV power line and the metallic object without the existing of the OHEW

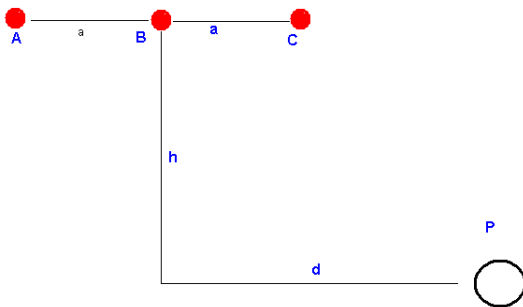

Fig. 4 Layout HV transmission line and metallic object

The voltage induced in the metallic object due to the full load current flowing in the transmission line is found using equation 8 [9]:

$$V_p = I_A Z_{Ap} + I_B Z_{Bp} + I_C Z_{Cp} \tag{9}$$

where

$V_p$  is the voltage induced on the pipe

$I_A, I_B$  &  $I_C$  is the full load phase current

$Z_{Ap}, Z_{Bp}$  &  $Z_{Cp}$  are the mutual impedance between the phase conductor and the metallic object

The mutual impedance is found using equation 9:

$$Z_{Phase-pipe} = 9.88 \times 10^{-7} f + j28.938 \times 10^{-7} f \log_{10} \left( \frac{D_e}{D_{phase-pipe}} \right) \tag{10}$$

$D_{phase-pipe}$  is the mean distance between the phase and the pipe, for example in Fig. 5  $D_{bp} = \sqrt{h^2 + d^2}$ , and  $f$  is the frequency.

$$D_e = 658.4 \sqrt{\frac{\rho}{f}} \tag{11}$$

$D_e$  is the Geometric Mean Distance

The existing of the OHEW under the full load condition increases the impact of the induced voltage on the pipeline. The OHEW breaks the balance of the system and leads to higher induced voltage on the pipe line. Fig. 5 shows the layout of the transmission like including the OHEW and the pipeline.

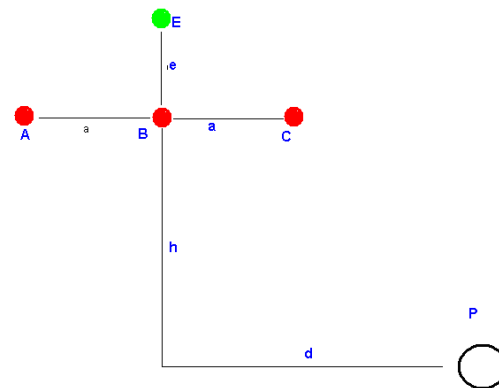

Fig. 5 Layout of the transmission line with the OHEW and the pipeline

Equation 12 shows the relation between the induced voltage in the pipe and the phase conductors:

$$V_p = I_A Z_{Aep} + I_B Z_{Bep} + I_C Z_{Cep} \tag{12}$$

where:  $Z_{AEP}$ ,  $Z_{BEP}$  &  $Z_{CEP}$  are found using the following equation:

$$Z_{phase-E-p} = Z_{Phase-p} - \frac{Z_{Ep}Z_{phase-E}}{Z_E} \quad (13)$$

where  $Z_{Phase-p}$ ,  $Z_{Ep}$  and  $Z_{phase-E}$  are determined using equation 10 and  $Z_E$  is determined using equation 14

$$Z_E = R_E + 9.88 \times 10^{-7} f + j28.938 \times 10^{-7} f \log_{10} \left( \frac{D_e}{R_{GM}} \right) \quad (14)$$

$R_{GM}$  is the geometric mean radius of the OHEW in m.

The existing of the OHEW reduces the mutual impedance between the transmission line and the pipe and changes the angle of mutual impedance.

*Split Factor/AC Interference*

Under the situation where two feeders are running in parallel using the same easement for a few kilometers, the current in one feeder will induce voltage/current in the OHEW of the second feeder. The induced voltage causes the rise of the earth potential on the earthing system of each structure on the second feeder. In the case where the other feeder is an underground feeder, the induced voltage/current will be in the cable screen of the other feeder. In addition, if the two feeders are connected to the same substation and the OHEW is terminated for both feeders in the substation earth grid, then the split factor will apply on the OHEW of the second feeder under any fault on the first feeder. Fig. 6 shows the layout of an example where the split and AC interference should be considered during the earthing design [10].

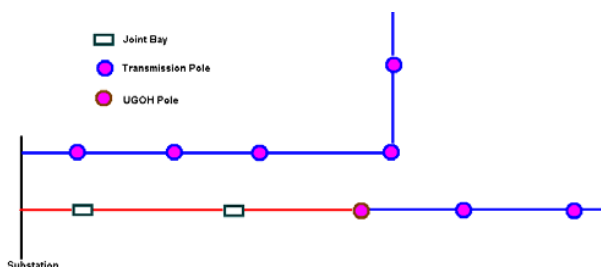

Fig. 6 OH and UG transmission mains

As shown in Fig. 6, the two transmission mains are running in parallel for a distance before they separate. This parallel distance causes the introduction of AC interference between the OH mains and into the screen of the UG cable. In addition, this is causing AC interference between the cable phase and OHEW of the OH mains. The distance between the phase conductor and the cable screen, the earthing system of the joint bay and the earthing system at the UGOH needs to taken into account since it impacts the safety performance of the system. The AC interference Creates an induced voltage in the

cable screen, the earthing system of the cable consists of: The earthing system at the joint bay and the earthing system of the UGOH pole

These 2 earthing systems need to be adequate to absorb the energy generated by the fault on the AC System. Different types of link boxes at the joint bay Causes different EPR at the UGOH pole under a fault in the OH transmission main. The earthing System for the Joint bay consists of a Link Box and single or multiple electrodes; the number is determined by the requirements to meet the maximum allowable resistance under the relevant utility regulations. Link box is where the cable screen of the cable is connected and terminated before bonding to the earth grid at the joint bay. In some cases the link box contain an SVL (Service Voltage Limiter) this SVL acts as an open circuit until the voltage reach a certain value. The existence of SVL in the Joint Bay Earthing System, forces the majority of the energy generated by the AC interference and the fault current to be absorbed by the UGOH pole earth grid. This can explain why the EPR at the UGOH pole is higher, since more current is passing through it [11-13].

Fig. 7 shows the proposed current flow due to the AC interference and the split factor. The fault induced/split current will drop to the ground at the link box or flow to the UGOH pole before it reaches the ground and take a path to the source using the ground and the adjacent OH feeder. The fault current on the OH feeder causes AC interference on the adjacent UG feeder. The connection of the faulted OHEW and the adjacent UG feeder cable screen to the same earth grid introduces the split factor. These two conditions, the parallel section and the connection to the same earth grid, ensure that the higher current will utilize the cable screen of the UG feeder as a return path. The current in the cable screen of the UG feeder find its way back to the source using the earth grid of the underground cable

The returning current that uses the cable screen has to find its way back to the source. However, because of the earthing arrangement at the joint bay, the current might not be able to find a path to the ground if there is an SVL. Therefore the first point of contact with the ground will be at the UGOH pole earth grid. The majority of the current is discharged at the UGOH pole earth grid because the source of the fault is in different direction of the cable feeder. In Fig. 7, the source of the OH feeder under fault is located at 90 degree of the UG feeder route. The current in the cable screen of the UG feeder needs to find its way to the source, when this fault current reaches the UGOH pole, it is discharged to the ground [14].

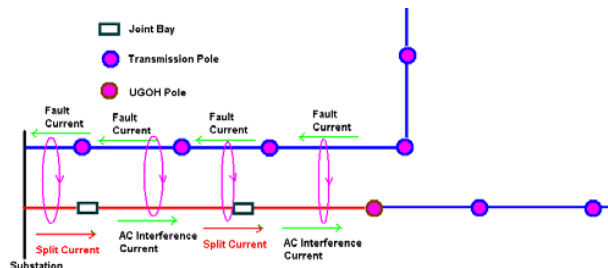

Fig. 7 Current flow in the cable screen under fault in the OH feeder

*Link Boxes*

The use of the sheath earthing link box is popular in UG feeder design and construction, it delivers a safe and reliable solution for minimising or elimination circulating cable sheath earth current in HV system. Different types of link boxes have been used in the industry, some with surge arrestor and some without. The one with the surge arrestor introduces an open circuit between the screen and the earth until a critical voltage exists, where it will break to protect the cable from void ionization and other damage to occur. Fig. 8 shows a picture of a link box.



Fig. 8 Link box

In Fig. 7, if the joint bay uses the link box where the surge arrestor exists, the current will only contact the earth when it reaches the UGOH pole. This creates a very high EPR at the UGOH pole. As a result one can conclude that under a fault in the OH feeder an EPR appears on the UGOH pole, this EPR represents the worst case scenario for the UGOH earthing system.

V. CASE STUDY

A Part of an upgrade project, it is required an additional 66kV feeder for Harbata ZS. The current arrangement, for Harbata ZS consist of an UG feeder 625 which is 66kV and 3 distribution 11kV feeders. The project requires the installation of another 66kV to Harbata ZS feeder 925, the design route is chosen to utilize the same easement of feeder 625 for 2.5 km before it deviates toward Labweh TS. Fig. 9 shows the layout of the two feeders.

The earthing design is conducted with the followings inputs:

- SL fault current: 5000A.
- Clearance Time: 350 ms.
- Existing UGOH pole earth grid resistance of 5 Ω.
- Harbata earth grid resistance is 0.9 Ω.
- Labweh earth grid resistance is 0.5 Ω.
- Average Soil Resistivity for the line is 50 Ω /m.
- UGOH pole earth grid consists of 10m electrode with 1 meter ring.
- Safety touch voltage under 350ms and 50ohm/m is given by 195V

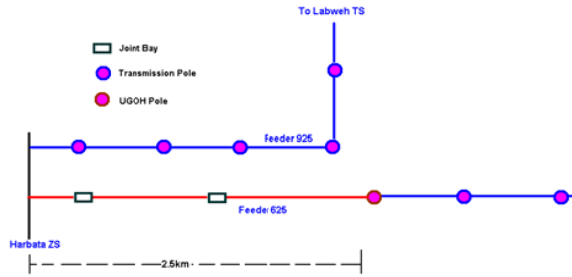

Fig. 9 Harbata ZS arrangement in respect of Feeder 925 and 625

The cable screen of feeder 625 is bonded to Harbata earth grid. The link boxes have a sheath voltage limiter. The OHEW on feeder 925 is bonded to Harbata earth grid, CDEGS simulation is conducted on feeder 925. The results of the split study shows 795.6A of the current utilise the cable screen of feeder 625 as a return path, this current will use the UGOH pole earthing system as a return to source.

The earth grid resistance at the UGOH pole is 5 Ω, the EPR created under the 795.6A is:

$$UGOH_{EPR} = 5 \times 795.6 = 3978V$$

Fig. 10 shows the touch voltage at the UGOH pole based on 795.6A fault current. The simulation shows a maximum touch voltage of 1500V as per contour 6 (contour 6 represent a person standing 0.5 -1 m away from the pole). However, if the person is standing on contour 3 which is less than 0.5m away from the pole, the computed touch voltage is 1200V. It is clear that this touch voltage doesn't comply with the safety criteria of 195V.

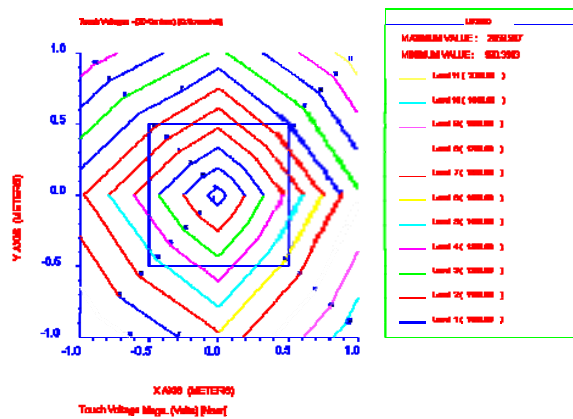

Fig. 10 Touch Voltage Contour at the UGOH pole

After establishing the connection between the cable screen on feeder 625 and the OHEW of feeder 925, the split study shows 925A is utilising the cable screen and only 120A is utilising the earth grid at the UGOH pole. Fig. 11 shows the touch voltage on the existing UGOH pole under the 120A fault current, the maximum touch voltage is computed and found to be 187V as per contour 4.

It is possible to observe the 795A by extending the earth grid of the UGOH pole as shown in Fig. 12, the touch voltage on the UGOH pole under the new earthing system is 100V as shown in contour 2. In general, it is rare for someone to stand more than one meter away from the pole and touch it, therefore contours that need be studied are the one that occupy less than one meter from the base of the pole.

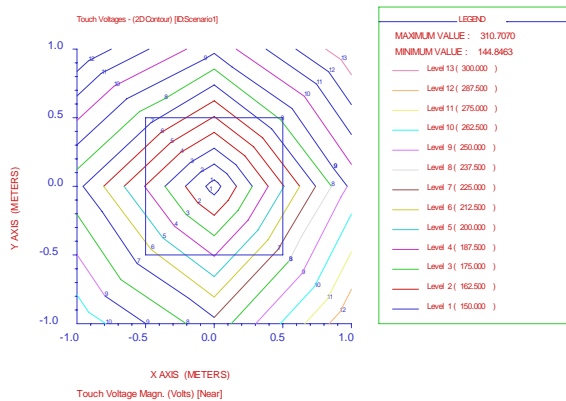

Fig. 11 Touch Voltage Contour under 120A fault current

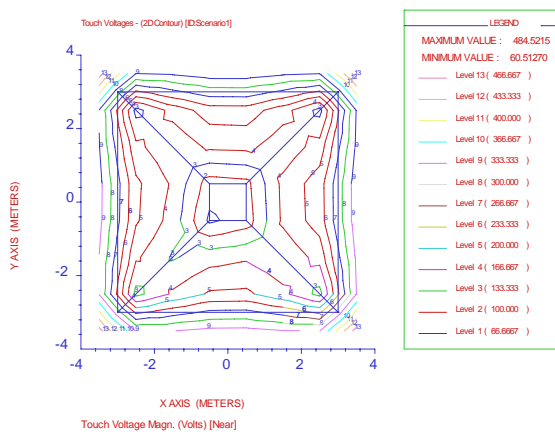

Fig. 12 Touch voltage Contour for the updated UGOH earth grid

## VI. CONCLUSION

This paper shows the need of analyzing the Ac interference of feeders if they are running in parallel within the same easement especially if they are both connected to the same substation at least in one end. It also emphasizes the significance of analyzing the return path of the fault current to make certain no unsafe situation will transpire. This paper proves that this split study can transfer the EPR outside the boundary of the substation and create an unsafe situation.

The voltage induced in the cable screen due to the AC interference needs to be taking into consideration when assessing the de-rating factor of the designed cable. This paper proves that it is vital to assess the UGOH pole of different feeder if it does occupy same easement to ensure the compliance of the system under fault conditions. Also it vital

to include the split current that use the cable screen as a return path when calculating the derating factor and cable sheath voltage rise.

## REFERENCES

- [1] IEEE guide to safety in AC substation grounding, 2000<sup>1</sup> (IEEE, New York, 2000).
- [2] Hellany A, Nagrial M, Jamal R, Nasserredine M, 2011, Soil Resistivity Structure and its implication on the Earth Grid of HV substation, *World Academy of Science, Engineering and Technology 60 2011*, vol 2011, no. 60, pp 1322-1326
- [3] Nasserredine M, Hellany A, 2009, AC Interference Study on Pipeline: the Impact of the OHEW under Full Load and Fault Current, Proceeding in the 2009 International Conference on Computer and Electrical Engineering, pp 497-501.
- [4] Nasserredine M, Hellany A, Nagrial M, "Analysis of the impact of the OHEW under full load and fault current" 2010, International Journal of Energy and Environment (IJEE), Volume 1, Issue 4, pp. 727-736.
- [5] IEEE guide to safety in AC substation grounding, 2000<sup>1</sup> (IEEE, New York, 2000).
- [6] Hellany A, Nagrial M, Jamal R, Nasserredine M, 2011, Soil Resistivity Structure and its implication on the Earth Grid of HV substation, *World Academy of Science, Engineering and Technology 60 2011*, vol 2011, no. 60, pp 1322-1326
- [7] Nasserredine M, Hellany A, 2009, AC Interference Study on Pipeline: the Impact of the OHEW under Full Load and Fault Current, Proceeding in the 2009 International Conference on Computer and Electrical Engineering, pp 497-501.
- [8] Nasserredine M, Hellany A, Nagrial M, "Analysis of the impact of the OHEW under full load and fault current" 2010, International Journal of Energy and Environment (IJEE), Volume 1, Issue 4, pp. 727-736.
- [9] Hellany A, Nasserredine M, Rizk J, 2009, How to design an effective earthing system to ensure the safety of the people, 2009 International Conference on Advances in Computational Tools for Engineering Applications, pp 416-421.
- [10] Nasserredine M, Hellany A. "OHEW Earthing Design Methodology of Traction Substation" 2010 World Academy of Science, engineering and Technology, Vol 66, no. 0, pp 1644-1648, ISSN 2070-66, [ORS ID:217809]
- [11] AS/NZS 4853:2000 electrical hazards on metallic pipelines
- [12] Hellany A, Nasserredine M, Nagrial M, Rizk J. "Safety Compliance of Substation Earthing Design" 2011 World Academy of Science, engineering and Technology, Vol 60, pp 525-529.
- [13] Nasserredine M, Hellany A. "Earthing Design Improvement: Correlation Between Design and Construction" 2010 World Academy of Science, engineering & Technology, no. 66, pp 1364-1367, ISSN2070-66.
- [14] C.N. Chang, "computation of current-division factors and assessment of earth-grid safety at 161/69kV indoor-type and outdoor-type substations" IEE proc.-Gener. Transm. Distrib., Vol. 152, No. 6, November 2005.
- [15] A. Campoccia, "A method to evaluate voltages to earth during an earth fault in an HV network in a system of interconnected earth electrodes of MV/LV substations" IEEE transactions on power delivery, Vol 23, No. 4, Oct 2008
- [16] S. Mangione, "A simple method for evaluation ground fault current transfer at the transition station of a combined overhead-cable line", IEEE transaction on power delivery, Vol, 23, No, 3, July 2008
- [17] E. Viel, "Fault current distribution in HV cable systems" IEE proc-Gener. Transmission distribution, Vol. 147, No. 4, July 2000
- [18] F. Dawalibi, "Measurements and computations of fault current distribution on overhead transmission lines" IEEE on transactions on power apparatus and systems, Vol. PAS-103, No. 3, March 1984.